

PRODUCT CATALOGUE
LED Light Fittings

2026/27

Light Management
Explosion-Proof Light Fittings
Dust- and Waterproof Light Fittings
High Bay Light Fittings
Outdoor Light Fittings
Emergency Light Fittings



Table of Contents

SCHUCH - a strong brand with tradition and future	2-13
Chronicle	2-3
No alternative to quality	4-5
Luminaires for Deutsche Bahn	6
Sustainability in focus	7-11
BestSelect - Great price. Great performance	12-13
Light Management	14-25
Light Management Systems	14
LIMAS Air - radio-based	15-17
LIMAS Line - wired	18-20
Luminaires for Light management	21
DALI and radio-based control	21
RFL - luminaires	22-24
EcoTune	25
LED Explosion Protected Fittings Zone 1/21	26-49
LIMAS Line	28
Light fittings with diffusers	29-41
Steep roof light fitting	42-43
High Bay light fitting	44-45
Floodlight	46-47
Ceiling- or Wall-mounting light fitting	48
Hand lamp	49
LED Explosion Protected Fittings Zone 2/22	50-70
Light fittings with diffusers	50-57
Steep roof light fitting	58-60
High Bay light fitting	61-64
Floodlights	65-70
Ex-Protected Installation Components	71-75
LED Dust-/Waterproof Light Fittings	76-131
LIMAS Air / LIMAS Line	78-79
Light fittings with diffusers	80-114
Oval shaped light fitting	115
Compact LED light fittings	116-118
Tubular light fittings	119-122
Sheet steel light fittings	123-126
Vandal proof light fittings	127-128
Mounting rails / through wiring systems	129-130
LED High Bays	132-161
LIMAS Air / LIMAS Line	134-135
1-point-mounting	136-146
2-point-mounting	147-156
Floodlights	157-160
LED Outdoor Light Fittings	162-227
LIMAS Air	164-165
Technical outdoor light fittings	166-185
Decorative outdoor light fittings	186-210
Floodlights	211-218
Large-Area Spotlight	219-223
Pole arm carriers/pole-top brackets/crossbars/cable	224-227
LED Emergency Light Fittings	228-247
LIMAS Air / LIMAS Line	230-31
Technical Supplement	248-261
Summary of the products	262

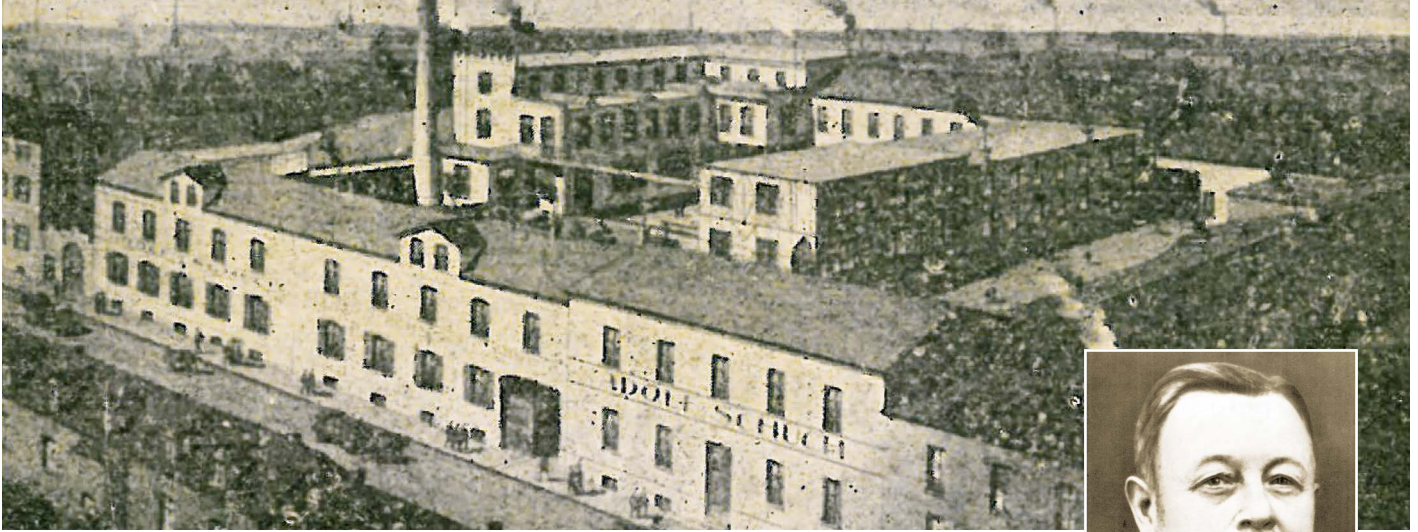

SCHUCH – a company with Traditions

CHRONICLE

2. March 1895

A few years after the invention of the incandescent lamp, Adolf Schuch founded the company Adolf Schuch Elektrotechnische Fabrik in Worms at the river Rhein.

He started the production of waterproof porcelain lamp holders for incandescent lamps, as well as waterproof porcelain hand lamps with protective glass for local breweries, tanneries and chemical plants.

1906

Production of first street light fittings.

1910

The first explosion-protected mining light fittings were delivered to coal mines in the Ruhr region, the Saarland and South Africa.

1929

With a comprehensive, innovative range of explosion-proof and weatherproof luminaires, SCHUCH became a pioneer for explosion-proof of light fittings.

1940

Large parts of the factory buildings are destroyed by the war. Continuation of production in alternative building.

21. February 1945

Destruction of all company premises and al-

ternative buildings as a result of intense bombing of Worms.

1945 -1948

Recovery of production. Launch of an improvised manufacturing program for night lamps, desk lamps, workplace and shop lamps, due to deficiency in raw materials.

1948

The production of explosion-protected light fittings, street light fittings and industrial and special-purpose light fittings of all types was restarted.

1949

Production of first light fittings for fluorescent tubes, as well as street light fittings for high pressure mercury lamps.

1952/1953

Fiberglass-reinforced polyester was used for the first time to produce housings for moisture-proof, explosion-protected and street light fittings.

In-house production of so-called "PREPREG" (preimpregnated fibres), and construction of an in-house moulding pressroom to produce fiberglass-reinforced polyester housings.

1953

First approval to use explosion-protected line-

ar light fittings for single-pin fluorescent tubes.

1957

As a result of the expansion of production demand, the company enlarged its working and storage areas by more than 14,000 m².

1962

The new plant II on the outskirts of worms got erected.

1964

The production was mostly moved into a new modern plant in the Mainzer Strasse in Worms, which included GRP pressing, mechanical workshops and a fully automatic powder-coating line.

1969

Expansion of the new plant to a total area of over 40,000 m².

SCHUCH achieved a deep vertical integration and extensive technologies for design and production of highly-protected technical light fittings.

1972

Start of production of the legendary 161/162 series waterproof light fittings.

A significant milestone in the history of the company.

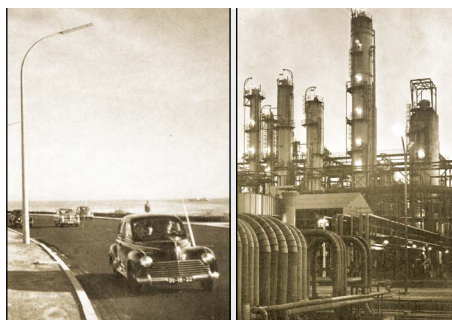



1975

A foamed polyurethane gasket was used in waterproof light fittings for the first time. The semi-automatic foaming systems required for this are manufactured in our own toolmaking shop.

1988/ 1989

World's first approval to use an explosion-protected linear light fitting for a 2-pin fluorescent tube.

SCHUCH became a pioneer for modern explosion-protected linear light fittings.

1995

Company's 100th Anniversary

First time certification of quality management system according to the new standard DIN ISO 9001.

1998

First approval worldwide of an ex-ECG with „end-of-life“ shutdown. Immediately afterwards, this will be included in the standard.

After 2000

The start of extending the standard manufacturing program, as well as special industry solutions for various application conditions in the industry.

2002

LED technology is revolutionizing lighting. From 2002, SCHUCH concentrated its development activities in all product areas on energy-efficient LED solutions.



2005 - 2009

An almost complete range of LED lights is created within a few years and successfully launched to the market.

2011

The LED range is complete with the introduction of the first ex-protected LED light fittings.

2014 - 2019

A phase of extensive investments begins, in which production capacities will be expanded in many areas by 2019, new production technologies will be introduced and energy-efficient renovations will be carried out according to the most modern, environmentally friendly aspects.

2016/2019

Lighting becomes smart:

introduction of the LIMAS Light Management System and so-called RFL lights, which are suitable for easy retrofitting of a Light Management System.

2019

SCHUCH is intensively investigating the influence of so-called harmful gases on LED luminaires. The results are being used to develop various RESISTANT luminaires across the entire product range.

2020

Now in its 5th generation, SCHUCH has been working competently, innovatively and with a



passion for good lighting for 125 years!

2021/22

On our way to becoming a climate-neutral company, further milestones can be reported, including the energy-efficient renovation of the main building, installation of a photovoltaic system, purchase of electric vehicles, and development of a charging infrastructure.

2023/24

The new GreenLine and BlackEdition labels showcase SCHUCH's commitment to sustainable product design. The GreenLine label covers all luminaires across all series that already meet future European eco-design requirements for sustainable products.

BlackEdition is the new generation of pole-top light fitting, which now also protects the night sky as decorative outdoor lights (ULOR = 0%).

2025

130 years of SCHUCH – a strong brand

Then as now: quality that lasts for generations and sustainability that shapes the future. Realignment of the lighting management division, which has grown steadily since 2016, with clear structures and a uniform umbrella organization.



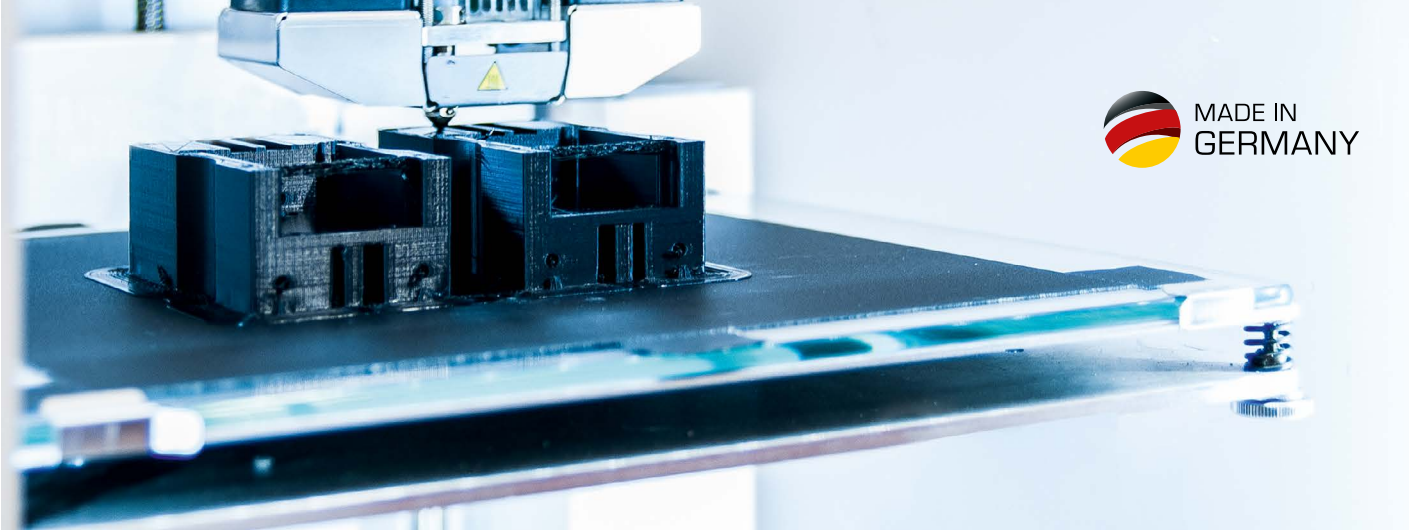

No alternative to quality

100% ORIGINAL SCHUCH

SCHUCH light fittings are unique branded products "Made in Germany". The proverbial high quality standard which you can rely on. Every single light fitting of our product range is an original SCHUCH product. Designed and engineered by our own engineers, produced using own tools and 100% quality approved in our own work shop. Unique and with it distinctive.

We have been regularly certified to **DIN EN ISO 9001** since 1995. Quality management covers all company activities, starting from design, engineering, production and final assembly to sale, and is valid for all product and manufacturing fields.

RESEARCH AND DEVELOPMENT

Our engineers use **advanced CAD systems** to design new light fittings and to optimise and modify current products according to individual customer needs. In the process, we benefit from our more than 130 years expertise and know-how in the field of lighting and from the collaboration with experienced materials specialists.

Thanks to our **thermal simulation programmes, in-house tooling department** and sample production using **3D printing**, as well as our manufacturing departments, our engineers can immediately examine the feasibility of their ideas and the suitability of the light fitting for its intended purpose.

R&D LABORATORIES

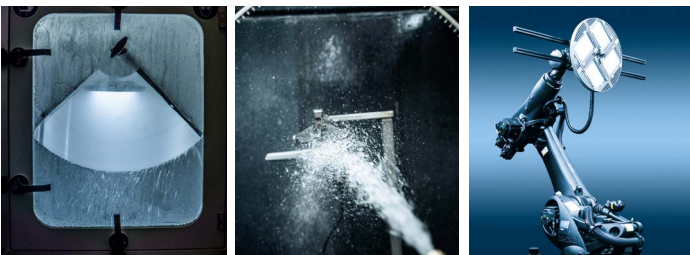

This is documented by the QM certificate in accordance with **DIN EN ISO 9001**, which has been regularly re-confirmed since 1995. The manufacture of explosion-protected lights and components is subject to even stricter monitoring with regard to quality management in accordance with **DIN EN ISO/IEC 80079-34**.

The highest quality standards from SCHUCH are also confirmed by the railway. **Since November 7th, 2019, SCHUCH has been a certified Q1 quality supplier to the railway company Deutsche Bahn AG.**



Our luminaires as well as components and materials are tested in our **own laboratory centre, accepted by VDE.**

Apart of **photometric measurements** of the luminaires on our **robot-supported LMT Metrogon**, luminous flux measurements and graphical representation in polar diagrams, the luminaires are **tested for emitted interferences and interference resistance** according to the EMC Directive 2004/108EG and electromagnetic compatibility rules.

Dust and water chambers are used to **check IP rating** of the light fittings, including sealing tests underwater. **Heat measurements** to check the maximum admissible ambient temperature, low temperature tests and material ageing tests performed in **climatic chambers**, especially for explosion-protected light fittings, finish the test program for SCHUCH light fittings.

TOOLING AND MECHANICAL MANUFACTURING DEPARTMENT

A **high vertical integration** is one of our key characteristics. Punching, cutting, bending and welding of metal parts are performed on most modern machining centres and welding robots. This results in housings, reflectors, mounting accessories made of sheet steel, aluminium and stainless steel in different shapes, sizes and specifications.

The tools required for punching, cutting and bending are produced and maintained in the **in-house tooling workshop**. This provides us with flexibility and independence and allows us to react promptly and flexibly to customer needs.



POLYESTER MOULDING PRESSES AND FOAMING PLANTS



Since 1955, all of our light fitting housings and reflectors made of fiberglass-reinforced polyester are produced on **in-house moulding presses**. Thanks to decades of expertise, we are fully aware of the optimal interaction of temperature, pressure, pressing time and material in order to produce highly resistant light fitting housings.

After appropriate storage, these housings as well as most of the die-cast aluminium housings are provided with foamed polyurethane or silicone gaskets in **fully automated dispensing systems**. Individual dispensing and foaming settings allow perfectly fitted gaskets for every housing and cover.

POWDER COATING AND WET COATING

All of our metal and die-cast housings as well as reflectors and other metal parts are powder coated in our most modern, energy efficient and eco-friendly **fully automated powder coating plant**. Every RAL or DB colour, depending on the customer's preferences, is possible. For the powder-coating of small batches, especially in special colours, the plant offers a **manual cabin** as well.

Polyester housings in outdoor areas are exposed to high loads by UV radiation and weather effects. In the course of time, this can lead to surface erosion of the housing with unsightly consequences for the visual appearance. Therefore, we offer our polyester outdoor light fittings with an UV protective coating (on request), that is applied in a separate wet **painting booth**.



FINAL ASSEMBLY AND TESTS



Careful manual assembly of the light fittings, **the combination of mechanical, electronic and optical components to the end product**, is performed in several assembly departments.

Finally, **every single light fitting undergoes specific functional tests**, before it is packed for delivery.

Continuous quality control, internal audits and trainings of our employees at all production stages ensure a high quality standard for all of our light fittings



Picture: ICE 3neo © Deutsche Bahn AG, Volker Emerleben

Luminaires for Deutsche Bahn

QUALITY COMES FIRST

We are accustomed to special requirements for our luminaires. Deutsche Bahn has been one of our satisfied customers for over 50 years. Our LED luminaires for trackside areas meet all brightness, uniformity and glare control requirements for train drivers and passengers. They also minimise disturbance for nearby residents, reduce light pollution and are energy efficient and cost-effective to maintain.

We offer a wide range of lighting solutions for trackside applications, from platform and track access lighting to technical room luminaires. Our products are designed for maximum ease of installation and maintenance while reliably meeting Deutsche Bahn's requirements. By regularly approving new product series, we ensure that we remain at the cutting edge of technology and can respond flexibly to Deutsche Bahn's needs.

Our current DB programme includes the following series:

- **Outdoor luminaire 47**
available in DB versions for optimal platform illumination
List sheet number: B 04.10.042
- **Outdoor luminaire 131 L09 nGgB**
specially developed for use in low trackway lighting
List sheet number: 1J4
- **Damp-proof light fittings 162**
available in DB versions for reliable lighting of wet or technical rooms
List sheet number: 5J10

Q1 quality supplier to Deutsche Bahn AG

SCHUCH is also certified by Deutsche Bahn as meeting the highest quality standards – not only in terms of product quality and process safety, but also regarding energy efficiency and sustainability. SCHUCH's Q1 certification is a seal of quality that Deutsche Bahn's planners and partner companies can rely on 100%.

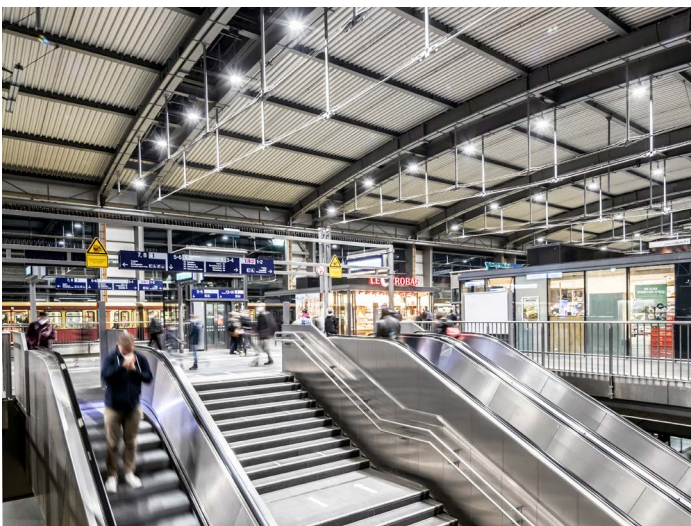



On the way to a climate-neutral company

As a manufacturing company, SCHUCH takes its environmental responsibility very seriously. Oriented towards long-term goals, our actions are consistently aligned with the **principle of sustainability**. Through responsible use of limited natural resources and the development of sustainable products, we make an active contribution to environmental protection for a future worth living for present and future generations.

Our luminaires are **not disposable products**. They are designed for high energy efficiency and long service life. The resulting energy savings and very long service lives help to conserve resources and reduce waste. All built-in components can be replaced by skilled personnel if necessary. The only exception is the PRIMO XR series, which must be hermetically sealed due to the application.

All SCHUCH products comply with the requirements of the **REACH** and **ROHS directives**. SCHUCH is a member of the recycling systems **Interzero®** and **Grüner Punkt** - Duales System Deutschland (DSD) for the proper disposal of packaging and the return and recycling of old equipment.

With permanent measures to **reduce our CO₂ emissions**, we have been on the way to becoming a climate-neutral company for years.

The most important **milestones** in recent years were:

- The energetic renovation of our main building
- The conversion of our entire factory lighting to LED with corresponding lighting control concepts
- The investment in a new powder coating plant designed according to the most modern environmentally friendly aspects.
- The installation of a photovoltaic system for our own power supply on the shed roofs of our production hall.
- The start of the conversion of our company vehicles to electric cars
- The establishment of a charging infrastructure at the Worms site

The consistent **focus on the development and production site in Worms** also minimises transport distances. In addition, the high degree of vertical integration ensures that preliminary products are often manufactured directly on site and do not have to be delivered over long distances. In addition, our facilities and production processes are intensively examined in **regular energy audits** for further energy-saving potential. Continuous internal process optimisations contribute to the optimal use of resources and the reduction of resource consumption.

As a responsible family business with a history of over 125 years, we are making our contribution to climate protection, reducing environmental pollution, lowering CO₂ emissions and conserving valuable resources.

Environmentally conscious printing

We are increasingly relying on the digital provision of information. If print products are nevertheless required, they are produced as environmentally friendly as possible (e.g. on recycled paper) and offset by supporting selected climate protection projects.

To this end, SCHUCH works together with various printing companies and renowned climatepartners.

Specifically, SCHUCH is using this catalogue to support a Gold Standard verified project that promotes the expansion of wind energy in Sri Lanka.





GreenLine – Sustainable product design in focus

In general, the following can certainly be said: the higher the quality of a luminaire, the more sustainable it is. In detail, however, a multitude of criteria determine the degree of sustainability of a luminaire.

The **Ecodesign for Sustainable Product Regulation (ESPR)**, which is expected in the future as part of the EU's „Green Deal“, puts these sustainability aspects into concrete terms.

Green Deal

The European Union has set itself the goal of zero net greenhouse gas emissions by 2050. Europe is thus to become the first climate-neutral continent. To achieve this ambitious goal, comprehensive measures are planned in the areas of financial market regulation, transport, energy supply, industry, trade, agriculture and forestry. Existing legislation is to be adapted to the EU's climate goals.

Ecodesign Regulation

The Ecodesign Regulation 2019/2020 (EU) sets, among other things, energy efficiency requirements for lighting products. The aim is to increase the efficiency of energy-related products, strengthen the circular economy and recycling and thus make a significant contribution to increasing sustainability and reducing greenhouse gas emissions.

Taxonomie Regulation

The EU Commission's Taxonomy Regulation sets binding standards for sustainable business. This is intended to guide investment in sustainable companies and technologies and thus support the Green Deal. The EU Taxonomy establishes comparable and reliable sustainability indicators across sectors.

With the new, cross-series **GreenLine** product line, we are meeting this special challenge!

GreenLine stands for outstandingly sustainable products in our range. For the classification of the luminaires, 12 (for outdoor luminaires 13) verifiable and objectively measurable sustainability criteria are used, which are based on the expected future European ecodesign requirements for sustainable products and additionally take into account the **Taxonomy Regulation**, which is intended to promote six sustainability goals defined by the EU as central.

This is illustrated by the following criteria 1 to 9, which anticipate future requirements that will only have to be met in a few years' time and are already being implemented today. In addition to these nine basic requirements, criteria 10 to 13 define requirements for environmentally friendly packaging, service life, energy efficiency and light emissions. These are supplementary voluntary requirements that must be met by all GreenLine products. All criteria are regularly reviewed and adjusted if necessary.

Basic requirements:

1. recycled material content $\geq 50\%$
2. modular design
3. use of standardised Zhaga compliant LED modules
4. interchangeability of ECG and LED modules
5. decomposability at end of life
6. recyclability $\geq 80\%$
7. upgradeability
8. product guarantee at least 5 years
9. spare parts availability at least 10 years

Additional requirements:

10. 100% recycled paper packaging
11. long service life
 - ⇒ Outdoor luminaires L90 > 100.000 h
 - Indoor luminaires L80 > 100.000 h
12. high system efficiency
 - ⇒ Outdoor luminaires > 140 lm/W
 - Indoor luminaires > 150 lm/W
13. ULOR = 0 for outdoor luminaires

SCHUCH LIGHT FITTINGS: COMMITTED TO THE ENVIRONMENT



Sustainable use of materials

Only the use of material from secondary raw materials leads to true circular economy. Components that represent a high proportion of materials in the luminaires are particularly important. GreenLine products have a recycle content of at least 50 % in relation to the weight of the luminaire. For outdoor luminaires, recycle percentages of 70 % and more are achievable.



Recyclability

GreenLine light fittings are very easy to dismantle into their individual parts thanks to their consistently modular design. This makes it easy to separate the different materials for recycling at the end of the luminaire's service life. The parts are highly recyclable, resulting in a rate of over 80 %. The GreenLine products thus make a significant contribution to the conservation of valuable resources.



Repairability & easy replacement of components

GreenLine luminaires are not disposable products, but always repairable. All components are easily replaceable, often even completely without tools. This saves expensive working time during maintenance, reduces possible disruptions to production or traffic to an absolute minimum and is an invaluable time and cost advantage.



Maintenance-friendly

When developing our products, we pay special attention to ease of maintenance and installation. Ideally, control gear and LED modules as well as other components can be replaced without tools. Maintenance-friendly luminaires are cost-efficient and save resources. The simple exchangeability of sub-components also ensures a long useful life of the light fittings.



Upgradeability, retrofittability & expandability with smart functions

The modular design of the luminaires means that many things are possible with GreenLine products. For example, the use of Zhaga compliant LED modules ensures the greatest possible flexibility in the use of efficiency upgrades and new LED generations. Standardised Zhaga bases in the RFL luminaires, on the other hand, enable the use of sensors for autonomous or smart control with the aid of a Light Management System. Here, type and time can be freely selected. This flexibility and wide availability provides future and investment security.



High energy efficiency

GreenLine products are highly efficient. To keep the luminaires at the highest efficiency level, we always use the latest LED generations. In combination with extremely effective optics, the optimal and efficient solution for the respective requirement is achieved, maximum energy is saved and the CO₂ impact on the environment is reduced to a minimum.



Long service life of the components & long duration of use of the luminaire

Thanks to the use of high-quality components from well-known brand manufacturers, GreenLine products have excellent service life values with L80>100,000 hours (for outdoor luminaires even L90>100,000 hours). With an average operating time of 4,200 hours per year for street luminaires, this corresponds to a period of almost 24 years. With 1-shift operation in the industrial sector, 34 years are achieved, with 2-shift operation at least 17 years and with round-the-clock operation still at least 11 years. However, the possible service life of a luminaire is considerably longer. To make use of this extremely long service life, all components are replaceable. This, and the low failure rate of electronic components, conserves resources, reduces waste and contributes significantly to the protection of our environment.



Long-term availability of replacement parts

The availability of spare parts for decades is standard at SCHUCH luminaires. Due to the high vertical range of manufacture, the renunciation of commercial goods (all SCHUCH luminaires are in-house developments) and the cooperation with renowned brand suppliers, the control of spare parts availability is largely in our hands. Even after a series has been discontinued, we guarantee the supply of spare parts for a period of at least 10 years.



Guarantee

The quality of our products and the satisfaction of our customers is our highest priority. We therefore grant a five-year guarantee on all catalogue products with a rated service life \geq 50,000 hours. This quality promise stands for the quality of our luminaires, is valid from the date of invoice and is valid without registration. Of course also for all GreenLine products.



ULOR = 0 & Dark Sky

Luminaires for outdoor use must be selected and positioned in such a way that disturbing light emissions into the environment are kept to a minimum or, if possible, avoided altogether. All GreenLine luminaires for outdoor use fulfil this requirement. This is made possible, among other things, by special optics with precisely defined light control, shielding, time and demand-dependent controls as well as special light colours that effectively limit adverse light immissions. Only outdoor luminaires that emit no light into the night sky (ULOR = 0) and thus meet the strict specifications of the International Dark Sky Association (IDA) are awarded the GreenLine label.



BlackEdition – Pole-top light fitting to protect the night sky

With the redesign of our mushroom lights, we are taking a further step towards the sustainable product design of our entire outdoor lighting range.

We have placed particular emphasis on the following product features: simple modular design, tool-free replacement of ECG and LED module and no direct light emission into the upper half-space (ULOR = 0 %). The latter feature in particular gives this new generation its name: **BlackEdition**.

BlackEdition luminaires impress across the board. They fulfil our high standards of quality, efficiency and sustainability – extremely important factors when it comes to making a purchase decision.

In contrast to technical luminaires, where DarkSky requirements can be realised relatively easily, the re-design of our mushroom luminaires had to combine aesthetics with the protection of the night sky for the first time.

We have achieved this without compromise – see for yourself!

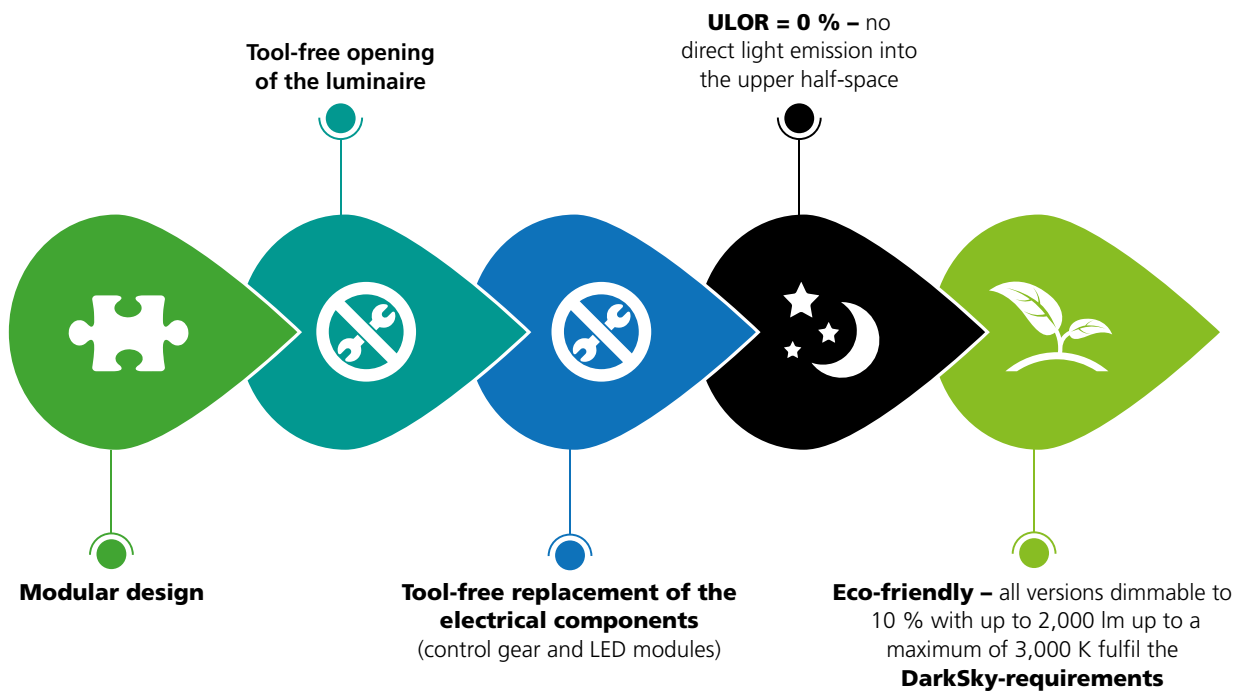



Modular design

Thanks to the modular design, the individual components can be replaced quickly and easily if necessary. The modular design also offers flexibility and adaptability: the luminaires can be adapted to specific requirements or future technical developments. This not only extends the service life of the luminaires, but also enables the different materials to be easily separated at the end of their service life.



Tool-free opening of the light

Installation, maintenance and fault rectification are particularly time-critical tasks for municipal street lighting. They affect traffic and can even lead to lane closures on one side and are not without danger for the installation personnel. Our BlackEdition luminaires can be opened without tools so that any work required can be carried out quickly and easily.



Tool-free replacement of electrical components

SCHUCH luminaires are not disposable products, but can always be maintained and repaired. The ECG and LED module can be replaced in no time at all without tools. This saves expensive labour time, reduces possible disruption to traffic to an absolute minimum and is an invaluable time and cost advantage, especially in the case of a planned group replacement.



ULOR = 0 %

Outdoor luminaires should be selected and positioned in such a way that disruptive light emissions into the environment are minimised or ideally avoided altogether. Our BlackEdition luminaires fulfil these requirements thanks to special optics with precise light control and shielding, among other things. The time- and demand-dependent controls and special light colours also help to effectively reduce disruptive light emissions.



Umweltfreundlich

All 10% dimmable versions with luminous fluxes up to 2,000 lm and colour temperatures up to a maximum of 3,000 K meet the strict requirements of the International Dark Sky Association (IDA). BlackEdition luminaires therefore make a special contribution to protecting the night sky and minimising light pollution..





BestSelect – Great price. Great performance.

THE LIGHTING RANGE FOR YOUR EVERYDAY LIFE.

BestSelect is a selection of tried-and-tested SCHUCH luminaires for your everyday needs. They impress with their unbeatable price-performance ratio, top efficiency and very long service life, and are readily available. This puts them at a clear advantage in terms of the cost-effectiveness and sustainability of investments.

Save time, reduce costs and choose SCHUCH quality. Your customers will appreciate it.

Our BestSelect range includes the following series:

- **Damp-proof light fitting**
LUXANO 2 VARIO – Simply ingenious and versatile
- **Outdoor light fittings**
FILOS VARIO – It couldn't be more universal
CAMINO VARIO – Streets in perfect light
- **High bay light fitting**
TRIANO disc – There is no alternative to quality



Article no.	Type	Connected load [W]	Luminous flux [lm] ¹	Luminous efficacy [lm/W]	Substitute for
16700 0020	167 12LG2 VARIO	18 – 30	2,700 – 4,300	143 – 150	1 x 36 W – 2 x 36 W
16700 0021	167 15LG2 VARIO	25 – 43	3,800 – 6,200	144 – 152	1 x 58 W – 2 x 58 W

Also available as a fully pre-assembled FC version.

FILOS VARIO

Article no.	Type	Colour	Connected load[W]	Luminous flux [lm] ¹	Luminous efficacy [lm/W]	Substitute for
42008 0001	42 L50 VARIO	Light grey RAL 7035	9 – 35	1,400 – 5,670	181	HST 35 – 2 x HST 70
42008 0002	42 L50 VARIO 730	Light grey RAL 7035	9 – 35	1,330 – 5,390	172	HST 35 – 2 x HST 70
42008 0501	42 L50 VARIO DB702	Mica-iron DB702	9 – 35	1,400 – 5,670	181	HST 35 – 2 x HST 70
42008 0502	42 L50 VARIO 730 DB702	Mica-iron DB702	9 – 35	2,330 – 5,390	172	HST 35 – 2 x HST 70

Also available with die-cast aluminium housing.

CAMINO VARIO

Article no.	Type	Connected load [W]	Luminous flux [lm] ¹	Luminous efficacy [lm/W]	Substitute for
48001 0703	48 L50 VARIO	9 – 35	1,330 – 5,480	172	HST 35 – 2 x HST 70
48001 0701	48 L50 VARIO 730	9 – 35	1,260 – 5,210	163	HST 35 – 2 x HST 70
48001 0750	48 L100 VARIO	16 – 50	2,730 – 11,140	177	HST 50 – HME 250
48001 0761	48 L100 VARIO 730	16 – 50	2,590 – 10,580	168	HST 50 – HME 250
48700 0002	4871 RAL 7035	Welded Aluminium Pole Arm Carrier for mounting outdoor light fittings on flat walls and corners of buildings.			
48700 0506	4871 DB702				

TRIANO disc

Article no.	Type	Connected load [W]	Luminous flux [lm]	Luminous efficacy [lm/W]	Colour temperature [K]	Substitute for
34100 0003	3410 L100B D	65	10,000	154	5,000	HME250
34200 0003	3420 L200B D	123	20,000	163	5,000	HIT250 / HME400
34200 0005	3420 L200TB D	123	20,000	163	5,000	HIT250 / HME400
34300 0003	3430 L300B D	195	30,000	154	5,000	HIT400
34300 0005	3430 L300TB D	195	30,000	154	5,000	HIT400
34100 0011	3410 L100B D 840	65	10,000	154	4,000	HME250
34200 0011	3420 L200B D 840	123	20,000	163	4,000	HIT250 / HME400
34200 0015	3420 L200TB D 840	123	20,000	163	4,000	HIT250 / HME400
34300 0014	3430 L300B D 840	195	30,000	154	4,000	HIT400
34300 0017	3430 L300TB D 840	195	30,000	154	4,000	HIT400

Rounded values, technical developments reserved.



Light management systems







OVERVIEW

Light only where it is needed, only when it is essential, only as bright as necessary and only as long as it is required - with the help of a Light Management System, the efficiency potential of LED technology can be optimally exploited.

Intelligent, demand-controlled light saves a great deal of energy costs and is extremely environmentally friendly and sustainable thanks to the considerable reduction in CO2 emissions associated

with it. In addition, the networking of the light points opens up a wide range of options.

Digital lighting, networking and intelligence can be approached in stages. From simple control via DALI luminaires to complex light management. SCHUCH always offers the right lighting solution for individual needs: whether wired or radio-controlled, permanently installed or upgradeable.

Function	 LIMAS Air SYNC	 LIMAS Air CASA	 LIMAS Air GUARD	 LIMAS Line BASIC	 LIMAS Line PRO	 LIMAS Line ESC
Radio-based	✓	✓	✓	✗	✗	✗
DALI	✗	✗	✗	✓	✓	✓
Emergency lighting monitoring	✗	✗	✓	✗	✓	✓
App control	✗	✓	✗	✓	✗	✗
Cloud control	optional	optional	✗	✗	✗	✗
Sensor integration	✓	✓	✗	✓	✓	✗
Extendability	✓	optional	✗	✗	✓	optional

LIMAS Air (SYNC / CASA / GUARD)

RADIO-BASED LIGHT MANAGEMENT

Whether replacing an existing system or installing a new one, with the **LIMAS Air** light management system you can now make your light system smart in no time at all and bring it to a new level. Extremely simple, fast and without additional installation effort.

LIMAS Air-equipped luminaires communicate via a self-healing mesh network, ensuring high reliability.

Integrating sensors enables efficient, demand-based control of the luminaires.

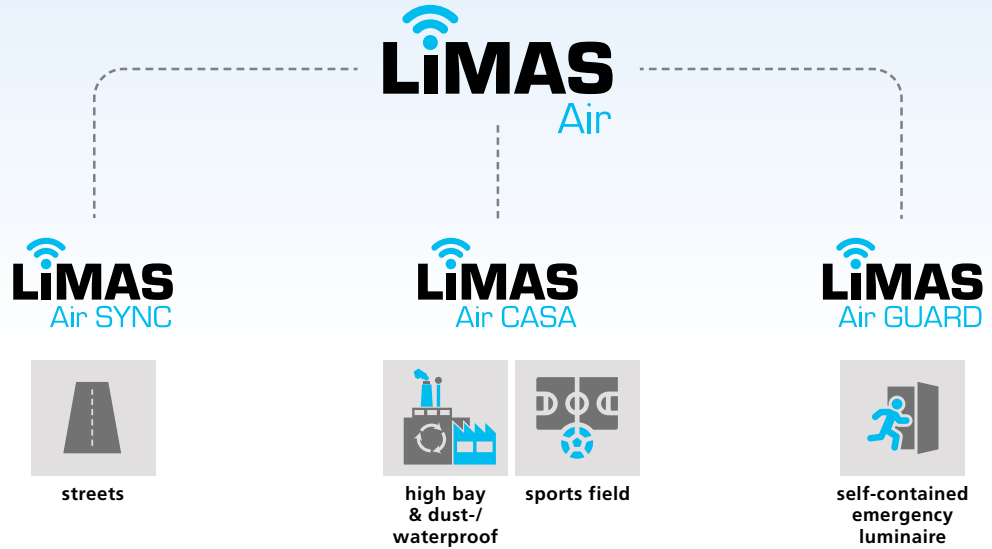

Radio-based light management system for outdoor light and smart city applications

Our **LIMAS Air SYNC** light management system allows a demand-based, intelligent control of lighting on streets, squares, parks and industrial areas. Even complex smart city projects can be easily implemented. The system enables wireless control and group-

ping of luminaires via a self-organising mesh network. Cloud connectivity is optional and can be implemented using special controllers. Integrated eSIM communication ensures secure data exchange with the cloud. The mesh network can also operate comple-

tely independently of the cloud, which is particularly advantageous for critical infrastructures.

Features / functions:

Technology	Radio-based (2.4 GHz, mesh network / cloud / eSIM)
Control	Cloud-based, via sensors, buttons or time profiles
Communication	Radio-based mesh communication, optional eSIM for cloud integration
Operation	Web interface via browser
Installation	No additional control line required
Visualisation	Map or list view with status display of all lights
Special feature	Smart city-compatible system with light-on-demand function



Radio-based light management system for industrial indoor areas and sports facilities

In many areas of an industrial or commercial enterprise, there is considerable potential for saving energy. For example, in production halls and warehouses, shelving aisles or even large areas such as car parks and sports facilities. By using new technology, a lot can usually be achieved here – especially in light systems. This is how intelligently controlled

LED lighting performs from the start to a noticeable reduction in costs and, in the sense of a sustainable corporate management, to a significant reduction in CO₂ emissions.

Our **LIMAS Air CASA** system enables wireless control and grouping of luminaires via a self-organising mesh network

(CASAMBI®). It also supports the integration of sensors and push buttons. Flexible, energy-efficient and easily controllable via app. Ideal for renovations, retrofits or new buildings where DALI cabling is not available or desired.

Features / functions:

Technology	Radio-based (2.4 GHz, mesh network)
Control	Movement / Daylight / Scene control / Push button
Communication	Radio networked, up to 250 components
Operation	CASAMBI® app (smartphone / tablet)
Installation	No wiring required
Visualisation	Floor plan display with lighting status
Special feature	Wireless system, ideal for renovations



Radio-based monitoring system for self-contained emergency luminaire

The reliable operation of emergency light systems is essential for commercial and industrial businesses. The easier the system is to install, monitor and control, the more efficient and comfortable it is for the operator. Our radio-based **LIMAS Air GUARD** light management system for monitoring,







controlling and testing self-contained emergency luminaires offers maximum efficiency and safety. It enables wireless communication between the luminaires and the control centre via a self-organising mesh network based on DALI or radio technology. This allows production halls, car parks, public build-

ings and all areas where emergency luminaires are operated without additional control cables to be conveniently monitored in accordance with the applicable standards.

Features / functions:

Technology	Radio-based (2.4 GHz, mesh network)
Function	Automatic testing and monitoring of self-contained emergency luminaires
Communication	Wireless connection between emergency lights and control centre
Operation	Web interface via browser
Visualisation	Clear status display of all lights with test report
Installation	No additional control line required
Norms	Complies with DIN EN 50172 / DIN VDE V 0108-100:2024-10
Special feature	Radio-based system with standard-compliant emergency light testing

System components

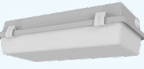
Type	Art.-Nr.		
LACA FM FC	90547 9001	CASAMBI® radio module with FastConnect quick-connector for controlling DIMD luminaires	
LACA FM MK1	90547 9002	CASAMBI® radio module with FastConnect quick-connector for controlling DIMD luminaires and 1.0 m cable	
LACA FM DALI PS120	90547 9010	CASAMBI® radio module with DALI power supply and broadcast control for up to 60 ECGs (total current 120 mA). Power supply 230 V	
LASC DONGLE USB + SOFT + LIZ	90543 0001	USB radio adapter including software and license for on-site setup / programming of LIMAS Air SYNC systems	
LACA BM/DS IR3	90547 9008	CASAMBI® motion and light sensor for mounting heights up to 2.2 m and a maximum detection range of 5.0 m in diameter	
LACA BM/DS IR10	90547 9014	CASAMBI® motion and light sensor for mounting heights of 2.0 – 10.0 m and a maximum detection range of 24,0 m in diameter	
LACA BM/DS IR16	90547 9013	CASAMBI® motion and light sensor for mounting heights of 5.0 – 16.0 m and a maximum detection range of 19.0 m x 30.0 m	
LACA BM/DS IR20	90547 9007	CASAMBI® motion and light sensor for mounting heights up to 20.0 m and a maximum detection range of 5.0 m in diameter	
LACA TASTIF4 UP	90547 9009	CASAMBI® push-button interface for connecting up to 4 volt-free push-button inputs. Designed for installation in a flush-mounted wall box	
LACA TAST4 AP	90547 9011	Battery-free, 4-button CASAMBI® radio switch. Actuating the switch generates the energy required to power the switch electronics	
LASC SENSBOX	90545 0047	DALI-2 controller for monitoring up to 192 self-contained emergency luminaires via radio on 3 DALI buses (additional system accessories and expert advice required)	
LACA SENSBOX	10183 0002	External unit with integrated RFLS socket for connecting a radio module (can be combined with LIMAS Air CASA)	
LASC SENSBOX	Request	External unit with integrated radio module (2.4 GHz mesh network) for integrating various functions into a LIMAS Air SYNC system (compatible with LIMAS Air SYNC controllers)	

LIMAS Line (BASIC / PRO / ESC)

WIRED LIGHT MANAGEMENT

Once set up, the compact, intelligent controller takes command of the entire light solution - fully automatically and according to the user's needs. The result is an easy-to-use, wired light control system, which creates ideal conditions for flexible use of space, in particular, focuses on the various needs of people and additionally reduces operating costs.

The available light fittings, sensors and controls leave nothing to be desired - from simple switching on and off and dimming, to user-defined lighting scenes and control of the emergency lighting and monitoring of self-contained emergency luminaire.

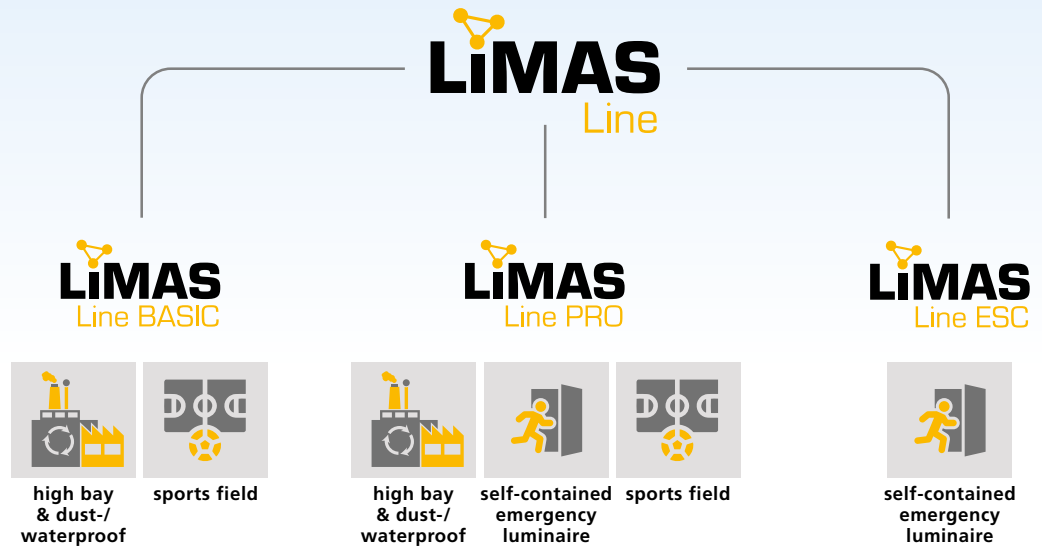

Wired light management system for small DALI projects

This light management system enables simple and efficient control of DALI luminaires without central emergency lighting monitoring. It allows easy addressing and grouping of luminaires, integration of standard push

buttons and sensor-based automation. **LIMAS Line BASIC** offers a compact alternative to the PRO version, both in terms of technology and dimensions. It is conveniently operated via an app and clearly dis-

plays all luminaires on a self-created floor plan, making it an ideal solution for small DALI projects in industry, commerce and administration – for example, warehouses, workshops and ancillary areas.

Features / functions:

Technology	Wired (DALI)
Control	App / Sensors / Push buttons
Emergency lighting monitoring	–
Operation	App-based configuration and control
Visualisation	Display of luminaires on self-created floor plans
Installation	DALI cabling required
Capacity	Up to 64 luminaires
Special feature	Wired system with app control



Wired light management system with emergency lighting monitoring and building management integration

This powerful wired light management system combines light control and emergency lighting monitoring in a single system. LIMAS Line PRO can be operated via PC or touch panel and clearly displays all luminaires

res in a central visualisation on a floor plan. It enables easy addressing and grouping of luminaires, the integration of standard push buttons and sensor-based automation. This makes it particularly suitable for industrial

halls, warehouses and logistics areas, production facilities and larger DALI projects, such as interior light systems with central control and emergency lighting monitoring.

Features / functions:

Technology	Wired (DALI)
Control	PC / Sensors / Push buttons / Time profiles
Emergency lighting monitoring	Integrated, automatic testing in accordance with DIN EN 50172
Operation	Via PC or touch panel
Visualisation	Display of all luminaires and emergency luminaires in the room (lichtMONITOR server licence required)
Installation	DALI cabling required
Capacity	Up to 192 luminaires, expandable to 960
Special feature	Wired system with central control and BACnet building management integration



Wired system for central monitoring of emergency lights

LIMAS Line ESC is used exclusively for the central control and monitoring of DALI emergency lights in accordance with the applicable standards (DIN EN 50172 VDE 0108-100:2024-1). This wired system enables convenient monitoring and

functional testing of emergency lighting in buildings such as industrial halls, public facilities, schools or office buildings. It is operated via a touch panel and clearly displays all emergency lights on a floor plan.

Features / functions:

Technology	Wired (DALI)
Control	Central monitoring and testing of self-contained DALI emergency luminaire
Emergency lighting monitoring	Integrated in accordance with DIN EN 50172
Operation	touch panel
Visualisation	Rudimentary representation using tiles
Installation	DALI cabling required
Capacity	Up to 64 luminaires, expandable to 256
Special feature	Wired system for compact emergency lighting solutions

System components

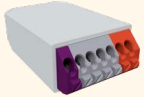
Type	Art.-Nr.		
LLBC CON	90545 0005	DALI-2 controller for controlling up to 64 devices	
LLPO CON	90545 0031	DALI-2 controller for controlling up to 192 devices across 3 DALI buses. Monitoring of self-contained emergency luminaires possible	
LLEC CON	90545 0042	7-inch touch panel with integrated DALI-2 controller for monitoring up to 64 self-contained emergency luminaires. Required accessories: DALI bus power supply (no. 90545 0016) and 24 V power supply (no. 90545 0043)	
LL BM/DS IR3	90545 0038	Infrared DALI-2 motion sensor with integrated light sensor for vertical wall mounting, suitable for installation heights of 1.8 – 2.5 m	
LL BM/DS IR4	90545 0035	Infrared DALI-2 motion sensor with integrated light sensor for mounting heights of 2.5 – 4.0 m	
LL BM/DS IR5	90545 0039	Infrared DALI-2 motion sensor with integrated light sensor for mounting heights of 2.5 – 5.0 m and a maximum detection range of 6.0 m x 23.0 m	
LL BM/DS IR14	90545 0036	Infrared DALI-2 motion sensor with integrated light sensor for mounting heights of 4.0 - 14.0 m	
LL BM/DS IR16	90545 0037	Infrared DALI-2 motion sensor with integrated light sensor for mounting heights of 4.0 - 16.0 m	
LL BM/DS HF4	90545 0040	High-frequency DALI-2 motion sensor with integrated light sensor for mounting heights of 2.0 – 4.0 m and a maximum detection range of 8.0 m in diameter	
LL XR DS4	90545 0045	DALI-2 light sensor in encapsulated housing for areas exposed to harmful gases and mounting heights of 2.0 to 4.0 m	
LL TASTIF4 UP	90545 0015	DALI-2 push-button interface for connecting up to 4 volt-free push-button inputs. Designed for installation in a flush-mounted wall box	
LLPO AKTOR 4X10	90545 0041	DALI-2 actuator with 4 volt-free outputs (max. 10 A). Suitable for signaling test states and system statuses of self-contained emergency luminaires	
LL DALI PS240	90545 0016	DALI bus power supply with up to 240 mA maximum output current	
LLEC PS	90545 0043	24 V power supply for touch panel (no. 90545 0042)	

Luminaires for light management systems

In order to control and monitor our luminaires using the listed light management systems, they must have the appropriate interfaces. The available interfaces are listed below. Further information on designs can be found in the catalogue for the relevant luminaires.

Wired control with DALI







These luminaires have a DALI interface that connects directly to both DALI lines. The DALI connections are reverse polarity protected. When planning, the number of ECGs (corresponding to the number of DALI addresses) must be taken into account.

- DIMD** The dimming range is generally 0-100 %. Luminaires with the suffix DIMD are compatible with: **LIMAS Line BASIC und PRO**
- MA-Z** These self-contained emergency luminaire cannot be dimmed, but only monitored. Lights with the suffix MA-Z are compatible with: **LIMAS Line ESC und PRO**
- DIMD MA-Z** The dimming range is generally 0-100%. Luminaires with the suffix DIMD MA-Z are compatible with: **LIMAS Line PRO**
- DIMDI** The dimming range is generally 0-100 %. This suffix only appears on EX-protected luminaires. Luminaires with the suffix DIMDI are compatible with: **LIMAS Line PRO**

Radio-based control

Luminaires with Casambi® technology bear our abbreviation CS. As Casambi® is controlled via radio, no additional terminal point is provided for the electrical connection.

- CS** The dimming range is generally 0-100%. Luminaires with the suffix CS are compatible with: **LIMAS Air CASA**
- MA-Z CS** Luminaires with the suffix MA-Z CS are self-contained emergency luminaires and can only be monitored. They are compatible with: **LIMAS Air GUARD**
- DIMD MA-Z CS** The dimming range is generally 0-100%. Luminaires with the suffix DIMD MA-Z CS are compatible with: **LIMAS Air GUARD**
- RFL** RFL luminaires are equipped with one or two bases (Zhaga Book 18) and are therefore ready for integration into light management systems. Luminaires with RFL bases are compatible with: **LIMAS Air SYNC or LIMAS Air CASA**

Luminaires suffix						
DIMD	✗	✓ ¹⁾	✗	✓	✓	✗
MA-Z	✗	✗	✗	✗	✓	✓
DIMD MA-Z	✗	✗	✗	✗	✓	✗
DIMDI	✗	✗	✗	✗	✓	✗
CS	✗	✓	✗	✗	✓ ²⁾	✗
MA-Z CS	✗	✗	✓	✗	✗	✗
DIMD MA-Z CS	✗	✗	✓	✗	✗	✗
RFL	✓	✓	✗	✗	✗	✗

¹⁾ only for hall bay luminaires with additional radio module

²⁾ only in conjunction with Casambi® Gateway

SENS/DIMC These luminaires can be controlled via a switching phase L'. SENS luminaires also have an integrated sensor. For more information, please refer to the DIMC/SENS catalogue pages on dust-/waterproof luminaires.

RFL - luminaires

When is the right time to implement a light management system? Right at the replacement of the conventional lighting or should you rather wait a few more years?

Our RFL luminaires, that are prepared for retrofitting light management components, keep all options open for the future. Timing is yours.

Concept „Ready For Light Management Systems“

One or two Zhaga Book 18 (Z18) compliant sockets with D4i control gear integrated into the luminaire housing enable the subsequent, tool-free installation of the necessary components such as controllers, radio antennas and sensors. The use of autonomous sensors without connection to a light management system is also possible at any time. RFL luminaires are available in various series and product ranges, such as outdoor or indoor luminaires. The product range is being continuously expanded.

Thanks to the standardisation of sockets in accordance with Zhaga Book 18 (Z18), you are not tied to our LIMAS Air light management system, but can choose freely from all manufacturers who also use standardised Zhaga socket connections.

Advantages















- Standardised Zhaga Book 18 (Z18) compliant sockets with D4i control gear in the luminaire housing
- Light management system can be added at any time
- Quick, tool-free installation of light management system components



System components

Type	Art.-Nr.		
RFL LASC DS	90546 9014	Controller for radio control of RFL luminaires (2.4 GHz mesh network) with photocell (twilight switching)	
RFL LASC DS GPS SIM	90546 9010	Controller for radio control of RFL luminaires (2.4 GHz mesh network) with GPS antenna (automatic luminaire position determination) and photocell (twilight switching), with integrated SIM card for connecting up to 100 adjacent nodes to the cloud. Enables remote configuration / commissioning and monitoring of the system, and provides timing in the system (GPS)	
RFL LASC BM RAD8	90546 9011	Controller for radio control of RFL luminaires (2.4 GHz mesh network) with integrated radar motion sensors, maximum mounting height 8.0 m	
RFL LASC BM RAD10 MA MK2	90546 9012	Controller for radio control of RFL luminaires (2.4 GHz mesh network) with integrated radar motion sensors, designed for pole mounting, maximum mounting height 10.0 m	
RFL BM RAD12	90546 9017	Radar motion sensor for RFL luminaires with mounting heights up to max. 12.0 m - only permitted in conjunction with RFL radio control (no. 90546 9014 and 90546 9010)	
RFL BM/DS IR8	90546 9004	Infrared motion sensor for RFL luminaires with mounting heights up to max. 8.0 m - only permitted in conjunction with RFL radio control (no. 90546 9014 and 90546 9010)	
RFL BM/DS IR12	90546 9018	Infrared motion sensor / twilight sensor for RFL luminaires with mounting heights up to max. 12.0 m, suitable for standalone operation or for use in combination with RFL radio control (no. 90546 9014 and 90546 9010), compatible accessory: shielding mask for limiting the detection area (no. 90546 9020).	
RFL DS20	90546 9000	Twilight sensor for autonomous control of RFL luminaires. Use in conjunction with other system components not permitted	
RFL LACA FM DS	90546 9013	CASAMBI® radio module with light sensor for RFL sockets	

Operating modes

		Radio networking	Motion detection	Twilight switching	Time-based control	Programm-ing	Connection to the cloud
1	RFL LASC DS GPS SIM	✓	✗	✓	✓	 	✓
	+ RFL BM/DS IR8	✓	✓	✓	✓	 	✓
	+ RFL BM RAD12	✓	✓	✓	✓	 	✓
	+ RFL BM/DS IR12	✓	✓	✓	✓	 	✓
2	RFL LASC DS	✓	✗	✓	Optional with article 1		Optional with article 1
	+ RFL BM/DS IR8	✓	✓	✓	Optional with article 1		Optional with article 1
	+ RFL BM RAD12	✓	✓	✓	Optional with article 1		Optional with article 1
	+ RFL BM/DS IR12	✓	✓	✓	Optional with article 1		Optional with article 1
3	RFL LASC BM RAD8	✓	✓	Optional with article 1 or 2	Optional with article 1		Optional with article 1
4	RFL LASC BM RAD10 MA MK2	✓	✓	Optional with article 1 or 2	Optional with article 1		Optional with article 1
5	RFL BM/DS IR12	✗	✓	✓	✗		✗
6	RFL DS20 *	✗	✗	✓	✗	✗	✗

 USB dongle

 Cloud connection

 Standard sensor programming, can be customised ex works



EcoTune

Good lighting must meet many requirements: ensure the safety of road users and residents, increasingly take ecological aspects into account, and offer urban planners opportunities to make inner-city areas more attractive. Static lighting does not meet these require-

ments. Adaptive systems, on the other hand, with which lighting can be flexibly adjusted to changing situations, offer many forward-looking solutions.

Change of the light colour

The combination of neutral white (4,000 K) and warm, natural light (2,200 K) creates pleasant, warm lighting in the evening and at night ('insect mode'). In the morning hours, the neutral white component is increased to ensure better visibility and greater safety as traffic increases. The multi-layer principle ensures uniform illumination at all times. Motion sensors also enable the light to be increased as needed when people or vehicles are present.

Change of light distribution

Rain, fog or snow can cause increased glare, especially on wet roads. Luminaires with two optics allow the light distribution to be adjusted: wide beam for dry roads, narrow beam for wet roads. This reduces glare and increases safety. Our AB and ABL optics already meet the normative requirements.



Advantages

- Independent adjustment of light colour and luminous flux
- Neutral white light in the early evening and morning enables good contrast vision and increases the attention of road users.
- Warm and dimmed light in the deep hours of the night helps residents to sleep, is particularly insect-friendly and minimises light emissions into the night sky
- Smooth transition between colour temperatures
- Multi-layer principle guarantees uniform illumination of the entire surface in the respective light colour combination.
- light colours can be combined according to customer requirements.
- Illuminance and dimming profile can be programmed on a customer-specific basis



Explosion-Protected Light Fittings

Impressive innovation strength in extreme conditions

For more than one hundred years SCHUCH has been considered as an expert in lighting in extreme environments. Applications in explosive gases and dust environments set stringent requirements.

With the results of its own intensive research and design work, as well as more than 100-year experience, SCHUCH still acts as an innovator in this challenging field. Thus, SCHUCH has decisively influenced much on the development of conventional explosion-protected linear light fittings, as well as of the relevant standards. Explosion-protected linear-light fittings with 2-pin technology are inseparably associated with SCHUCH. Using the new LED technology, SCHUCH sets new benchmarks with its innovative solutions. Worldwide, SCHUCH has one of the widest ranges of lighting products providing protection against explosive gases and dusts.

HIGHLIGHTS OF TECHNOLOGICAL DEVELOPMENT - SCHUCH AS A PIONEER

1910

The first SCHUCH mining light fittings illuminate the coal mines in the Saarland and in the Ruhr region and are delivered to the mines in South Africa.

1929

SCHUCH disposes of an extensive range of explosion-protected and mining luminaires, junction boxes, switches and sockets. The product line of explosion-protected light fittings is a major sector within the entire manufacturing program.

1952/53

Introduction of „glass fiber reinforced Polyester“ as material for the housings of explosion-proof light fittings.

1953

First approval of an explosion-protected ceiling light fitting for single-pin fluorescent tubes.

1986

After substantial development work, SCHUCH got the world's first certification of an explosion-protected electronic control gear for 2-pin fluorescent tubes.

1989

World innovation: SCHUCH presents the first explosion-protected linear light fitting with an ECG for standard 2-pin fluorescent tubes. A pioneering solution that enables to generally use conventional fluorescent tubes in explosion-protected light fittings. Thus, SCHUCH became the forerunner of modern explosion-protected linear light fittings.

1998

With the world's first approval of an Ex-ECG with „end-of-life“ shutdown, a safety gap in the operation of explosion proof light fittings is being closed - SCHUCH is making history again. Immediately afterwards, this becomes bindingly included in the standards.

2005

First approval of an explosion-protected linear emergency light fitting with a microprocessor-controlled intelligent emergency control unit and an integrated ECG with "end-of-life" cut-off system.

2010

First explosion-protected linear light fitting for Zone 2 and Zone 22 with the application of an energy-saving T5 lamp technology.

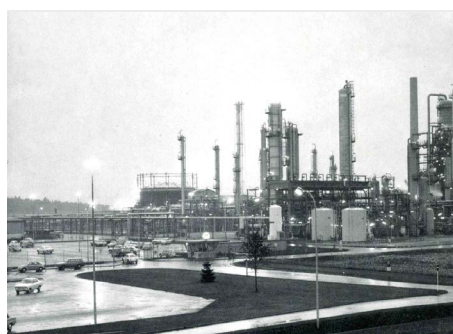

Product	Series	Page
Light management		
LIMAS Line - Wired light management system		28
Light fittings for Zone 1/21		
Light fittings with diffuser ExeLED 1	e865...	29-31
• with DALI interface	... DIMD	30
• for high ambient temperatures	... H..	30
• for low ambient temperatures	... T40	30
Emergency light fittings ExeLED 1 N	e864...	32-34
Light fittings with diffuser with central locking system	e840...	35-36
Pole mounted light fittings	e840... PM	36
Compact light fittings with diffuser	e855...	37-38
Compact emergency light fittings	e856...	39-41
Steep roof light fitting	e821...	42-43
• with DALI interface	... DIMD	43
High bay light fittings ExSTREAM	e8825...	44-45
• with DALI interface	... DIMD	45
Floodlights ExSTREAM	e8820...	46-47
• with DALI interface	... DIMD	47
Ceiling- or Wall-mounting light fitting ExGLOBE	e9312...	48
Hand lamp ExSPECT	e9310...	49
Light fittings for Zone 2/22		
Light fittings with diffuser ExeLED 2	nD866...	50-52
• with DALI interface	... DIMD	51
• for high ambient temperatures	... H..	51
Emergency light fittings ExeLED 2 N	nD867...	53-55
Compact emergency./ escape light fittings	nD8611...	56-57
Steep roof light fitting	nD822...	58-60
• with DALI interface	... DIMD	59
High bay light fittings ExDUEVO	nD8301/02...	61-62
High bay light fitting ExAREALO 2	nD8955...	63-64
Floodlights ExFOCO L	nD8700...	65-66
Plane surface floodlights ExFOCO L	nD8700... A	66
Floodlights ExFOCO XL	nD8800...	67-68
Plane surface floodlights ExFOCO XL	nD8800... A	68
Floodlight ExAREALO 2	nD8950...	69-70
Ex-Installation material		
Carrier rail systems	TRS 2000/AL	71
Through-wiring systems	DV	72
Wall sockets	4216	73
Plugs	4210	73
Installation switches	8040	74
Junction boxes	8118	74

LED TECHNOLOGY

2011

SCHUCH brought the first EX-protected LED headlights, emergency and compact light fittings to market maturity.

2014

First approval of explosion-protected linear LED light fittings, high bay LED light fittings and LED floodlights for Zone 2/22.

2016

Following intensive fundamental research, SCHUCH is presenting the **ExeLed 1** at Light + Building, the world's first Zone 1/21 LED Ex linear luminaire with innovative encapsulation technology for the LED modules.

2017-19

The range of LED light fittings is expanding at a rapid pace. The **ExeLed1 N** and **ExeLed 2 N** emergency light fittings, LED floodlights and surface floodlights, as well as compact diffuser light fittings and emergency light fittings follow in short intervals.

2020-2023

With the introduction of steep roof light fittings, floodlights and high bay light fittings of the **ExSTREAM** Zone 1/21 series, compact wall and ceiling mounted light fittings and the hand lamp **ExSPECT**, the LED range gets expanded continuously. • Furthermore, light management options are also becoming available for explosion-proof light fittings.

2025

The new **ExAREALO 2** proves to be a true all-rounder and is modified for use in Zone 2/22. As a high-bay light fitting and floodlight, it completes the lighting range.





Wired light management system

With the wired **LIMAS Line** light management system, SCHUCH DIMD luminaires can also be intelligently controlled in hazardous areas. This allows lighting systems to be efficiently adapted to actual requirements, delivering sustainable economic and ecological benefits.

The system components are installed outside the explosion-proof area.

LIMAS Line BASIC

Wired light management system for small DALI projects



LIMAS Line BASIC enables fully automated, dynamic light in conjunction with the corresponding sensors. Configuration is carried out using a smart end device (Android or iOS) via a wireless connection. This only requires a free app with which the room to be illuminated can be recreated and equipped and configured with luminaires, sensors and push-buttons.

LIMAS Line PRO

Wired light management system with emergency lighting monitoring / building management integration

LIMAS Line PRO offers you extended options and additional functions. In addition to DALI luminaires (DIMDI), all self-contained emergency luminaires (DI und DIMDI) in the SCHUCH portfolio can also be controlled and monitored. Configuration and control are carried out via PC without additional software - a browser is sufficient. The connection between the PC and LIMAS Line PRO can be realised either via an existing network or by establishing a peer-to-peer connection. An Internet connection is not required. For further details and properties, see the chapter on light management systems.

System accessories (Installation outside the explosion-protected area only)

Type	Art.-No.		
LL BM/DS HF4	90545 0040	High-frequency DALI-2 motion sensor with integrated light sensor for mounting heights of 2.0 – 4.0 m and a maximum detection range of 8.0 m in diameter	
LL BM/DS IR14	90545 0036	Infrared DALI-2 motion sensor with integrated light sensor for mounting heights of 4.0 - 14.0 m	
LL BM/DS IR16	90545 0037	Infrared DALI-2 motion sensor with integrated light sensor for mounting heights of 4.0 - 16.0 m	
LL BM/DS IR3	90545 0038	Infrared DALI-2 motion sensor with integrated light sensor for vertical wall mounting, suitable for installation heights of 1.8 – 2.5 m	
LL BM/DS IR4	90545 0035	Infrared DALI-2 motion sensor with integrated light sensor for mounting heights of 2.5 – 4.0 m	
LL BM/DS IR5	90545 0039	Infrared DALI-2 motion sensor with integrated light sensor for mounting heights of 2.5 – 5.0 m and a maximum detection range of 6.0 m x 23.0 m	
LL DALI PS240	90545 0016	DALI bus power supply with up to 240 mA maximum output current	
LL TASTIF4 UP	90545 0015	DALI-2 push-button interface for connecting up to 4 volt-free push-button inputs. Designed for installation in a flush-mounted wall box	
LLBC CON	90545 0005	DALI-2 controller for controlling up to 64 devices	
LLPO AKTOR 4X10	90545 0041	DALI-2 actuator with 4 volt-free outputs (max. 10 A). Suitable for signaling test states and system statuses of self-contained emergency luminaires	
LLPO CON	90545 0031	DALI-2 controller for controlling up to 192 devices across 3 DALI buses. Monitoring of self-contained emergency luminaires possible	



ExeLED 1

LED-Light Fitting for Ex-Zone 1/21

Series e865...

Applications:

Hazardous locations of zones 1/2 (gas) and 21/22 (dust).

Design:

Housing: Glass fibre reinforced polyester resin.

Cover: Injected polycarbonate, frosted (F), silicone gasket.

Closure: Stainless steel clips (KE), two of them as safety clip (KES), to be opened with screwdriver only.

Reflector: Sheet Steel, painted, carrying the encapsulated LED-modules, clipped into the cover, removable as a unit.

Connection: 3 poles up to 4 mm².

Cable entries: 3 entries M25 x 1.5, (2 glands - one of them is plugged)

Standard: Facing downwards or forwards.

Mechanical installation:

Mounting accessories see spare parts/ accessories.

Technical Data:

LED: Line modules appr. 6,500 K, CRI > 80, service life L₈₀ > 100,000 h at max. ambient temperature, L₉₀ > 85,000 h (06L..) at 25 °C ambient temperature, L₉₀ > 80,000 h (12L..) at 25 °C ambient temperature

ECG: 220-240 V AC/DC, 0 or 50/60 Hz, overvoltage, overload and short circuit protection

Options:

- 4,500K; light colour (845)
- through-wiring (DV)
- for higher ambient temperatures temperatures (H70), up to +70 °C
- only for explosive dust areas zone 21
- for connection to central emergency supply systems (ZB)
- for connection to central emergency supply systems with integrated monitoring module



Note:

This light fitting is not suitable for application in areas with permanent high humidity in combination with only short periods of operation, such as sewage or stormwater retention tanks or water treatment plants.

e865 06L..

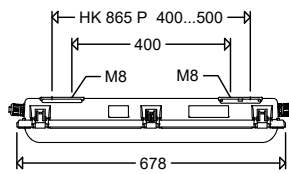

e865 12L..

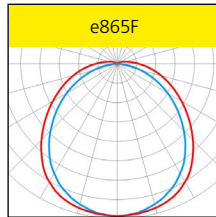
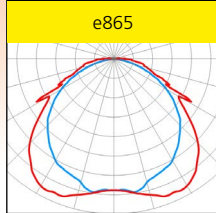
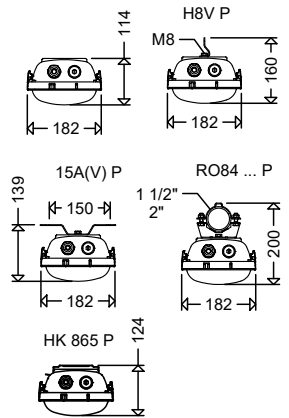
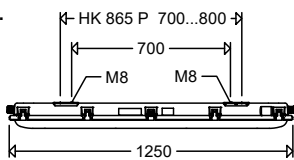

Product highlights:

- the light fittings are suitable for use in food areas IFS
- innovative encapsulation with high transmission rate
- LED-Modules protected from mechanical or electrostatic damages by sandwich design of reflector and cover
- homogeneous illumination by using frosted diffusers no individual light points visible, comfortable perception of light, brilliant glare limitation
- high colour rendering index CRI > 80, according to the workplace guide lines suitable for nearly all plant locations
- FastFix mounting, system for variable mounting distances and easy installation (retaining clips HK865 P) without opening the fitting
- sustainable, control gear and reflector with LED-modules replaceable by qualified personnel on-site
- the light fittings are suitable for use in food areas (IFS/HACCP), see chapter 9.1 in the „Technical Supplement“

Article no.	Type	Connected load [W]	Luminous flux [lm]	Luminous efficacy [lm/W]	Cover frosted	Cover clear	Ta max [°C]	Substitute for *	Weight [kg] (without packing material)
e865...				II 2 G Ex eb mb q IIC T4 Gb		II 2 D Ex tb IIIC T80°C Db		IP66	

EU-Type Examination Certificate:

ATEX: IBEExU 16 ATEX 1008X

Other approvals:

IECEx: IECEx IBE 16.0010X

Ignition protection: eb

Marking:

II 2 G Ex eb mb q IIC T4 Gb (Zone 1)

II 2 D Ex tb IIIC T80°C Db (Zone 21)

Rated voltage: 220-240 V AC/DC, 0 or 50/60 Hz.

Permissible ambient temperature:

-30 °C up to see article table

The values apply to versions with through-wiring.

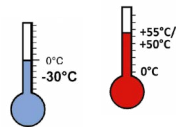

Pole mount with pipe clamps RO84P

Properties, limitations and details for controlling LED-light fittings:

See "Technical Supplement"

All data are correct at the time of printing. Actual technical data can be found under www.schuch.de.

* The given information is for rough orientation only. In each individual case a lighting calculation is necessary.

86500 0050	e865F 06L22	15	2.170	145	•	55	2 x 18W	4,6
86500 0051	e865F 06L42	28	4.120	147	•	55	2 x 36W	4,7
86500 0052	e865F 06L60	40	5.700	143	•	50	2 x 58W	4,7
86500 0001	e865F 12L42	28	4.360	156	•	55	2 x 36W	6,7
86500 0002	e865F 12L60	40	6.020	151	•	55	2 x 58W	6,7
86500 0003	e865F 12L85	54	8.620	160	•	50	> 2 x 58W	7,0



Looping the cable on one side:

All light fittings of series e865... have got 2 cable entries on one small side of the housing for cable looping instead of the through-wiring system.

Article no.	Type	Connected load [W]	Luminous flux [lm]	Luminous efficacy [lm/W]	Cover frosted	Cover clear	Ta max [°C]	Substitute for *	Weight [kg] (without packing material)
-------------	------	--------------------	--------------------	--------------------------	---------------	-------------	-------------	------------------	--

e865... DIMD

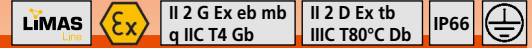

dimmable via DALI interface

Design:
Same as standard version, but with DALI-2 compatible ECG and 2 additional clamping points, marked with DA. Compatible with LIMAS Line BASIC/PRO Light Management System.

Note:
The conducting wires to the control input must be mains voltage stable and can be integrated in the connection cable.

86500 0952	e865F 06L42 DIMD	28	4.120	147	•		55	2 x 36W	4,7
86500 0953	e865F 06L60 DIMD	40	5.700	143	•		50	2 x 58W	4,7
86500 0914	e865F 12L42 DIMD	28	4.360	156	•		55	2 x 36W	6,7
86500 0913	e865F 12L60 DIMD	40	6.020	151	•		55	2 x 58W	6,7
86500 0903	e865F 12L85 DIMD	54	8.620	160	•		50	> 2 x 58W	7,0

e865... H..



for high temperature ¹⁾

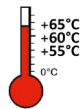

86500 0053	e865F 06L22 H65	15	2.170	145	•		65	2 x 18W	4,6
86500 0054	e865F 06L42 H60	28	4.120	147	•		60	2 x 36W	4,7
86500 0055	e865F 06L60 H55	40	5.700	143	•		55	2 x 58W	4,7
86500 0910	e865F 12L42 H65	28	4.360	156	•		65	2 x 36W	6,7
86500 0902	e865F 12L60 H65	40	6.020	151	•		65	2 x 58W	6,7

e865... T40



for low ambient temperatures down to -40 °C

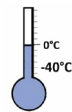

86500 0065	e865F 06L22 T40	15	2.170	145	•		55	2 x 18W	4,6
86500 0066	e865F 06L42 T40	28	4.120	147	•		55	2 x 36W	4,7
86500 0023	e865F 12L42 T40	28	4.360	156	•		55	2 x 36W	6,7
86500 0024	e865F 12L60 T40	40	6.020	151	•		55	2 x 58W	6,7

* The given information is for rough orientation only. In each individual case a lighting calculation is necessary.

¹⁾ through-wiring or looping the cable is not permissible.

Accessories / Spare Parts

Article No.	Type	
Spare diffusers		
86601 9001	ABD 8654F	cover, frosted PC diffuser, for e864F 12 ..., e865 12..., nD866F 12..., nD867F 12 ...
86601 9014	ABD 8652F	cover, frosted PC diffuser, for e864F 06 ..., e865F 06 ..., nD866F 06 ..., nD867F 06 ...
86601 9000	ABD 8654	cover, diffuser PC clear, for e864 12 ..., e865 12 ..., nD866 12 ..., nD867 12 ...
Fasteners		
90055 9004	KE/KES VE10	stainless steel, incl. 2 safety clips (packing unit 10 pcs.) see picture on the left, for e865 12L.. until year of manufacture 2020
90055 9005	KES P	1 pair of safety clips stainless steel for e865 12L.. until year of manufacture 2020
90055 9007	KE/KES G2 VE10	stainless steel, incl. 2 safety clips (packing unit 10 pcs.) see picture on the left, for e865 12L.. from year of manufacture 2020 and for e865 06L..
90055 9006	KES G2 P	1 pair of safety clips stainless steel for e865 12L.. from year of manufacture 2020 and for e865 06L..
Glands/breather		
90117 9006	2537 G	ex-protected plastic cable gland M25 x 1,5 with locknut
90118 9006	2538 G	ex-protected plastic plug M25 x 1,5 with locknut
90119 9001	2539 G	ex-protected plastic cable gland M25 x 1,5 with blanking plug and locknut
90259 9000	KS25 G EX	ex-breather M25 x 1,5
Mounting material		
86501 9003	HK 865 P	2 retaining clips for variable mounting in indoor areas
90001 0002	H8V P	2 suspensions eyes with bolts, stainless steel
90000 0002	DS 15A P	2 ceiling brackets, hot galvanized steel
90032 0002	DS 15AV P	2 ceiling brackets, stainless steel
90037 0004	RO84 112 A P	2 pipe clamps 1 ½", stainless steel, with support also for pole mounting
90038 0004	RO84 2 A P	2 pipe clamps 2", stainless steel, with support also for pole mounting
26000 0008	WW 26 L P	2 wall mounting angles, hot galvanized steel
26000 0002	WW 26 30 P	2 wall mounting angles 30°, hot galvanized steel
26000 0003	WW 26 45 P	2 wall mounting angles 45°, hot galvanized steel

Fasteners

KE/KES VE10
KES P



KE/KES G2 VE10
KES G2 P



Pipe clamps

2 pipe clamps 1 ½",
stainless steel, with
support

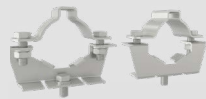

2 pipe clamps 2",
stainless steel, with
support





ExeLED 1 N LED-Emergency Light Fitting for Ex-Zone 1/21 Series e864...

Applications:

Hazardous locations of Zones 1/2 (gas) and 21/22 (dust), for illuminating escape routes.

Design:

Housing: Glass fibre reinforced polyester with separate battery box at one small side of the housing.

Cover: Injected polycarbonate, frosted (F), silicone gasket.

Closure: Stainless steel clips (KE), two of them as safety clip (KES), to be opened with screwdriver only.

Reflector: Sheet Steel, painted, carrying the encapsulated LED-modules, clipped into the cover, suspendable.

Connection: 4 poles up to 4 mm².

Cable entries: 2 entries M25 x 1.5 at one small side of the housing, (2 glands - one of them is plugged)

Standard: Facing downwards or forwards.

Mechanical installation:

Mounting accessories see spare parts/accessories.

Technical Data:

LED: Line modules appr. 6,500 K, CRI > 80, service life L₈₀ > 100,000 h at max. ambient temperature, L₉₀ > 95,000 h (06L..) at 25 °C ambient temperature, L₉₀ > 85,000 h (12L..) at 25 °C ambient temperature

ECG with an integrated emergency control unit

Incorporated NiMH battery, electronic charger, short circuit protected battery and reverse battery protection

Electronic deep discharge protection: acc. to EN 61347-2-7

Re-charging time: 24 h, acc. to EN 60598-2-22

Automatic monitoring: of the emergency light fitting according to EN 62034, indication of the test results by 2-coloured LED (luminescence diode) at the luminaire

Mode of operation:

maintained operation = switching over to battery operation in case of mains failure, line modules will be operated with reduced luminous flux as emergency lighting.

stand-by operation = switching on in case of mains failure.

Options:

- 4,500 K; light colour (845)
- through-wiring (DV)
- remote switch-off device

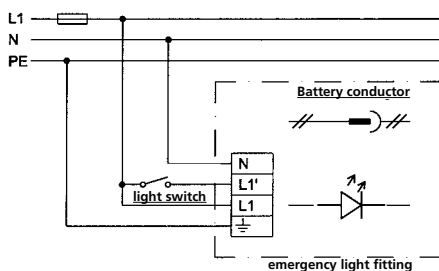

Starting:

Connect battery conductor.

Out-of-operation: separate battery conductor.

Stand-by operation: Do not connect L1'.

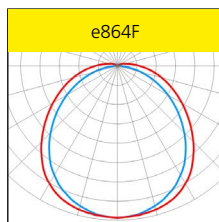
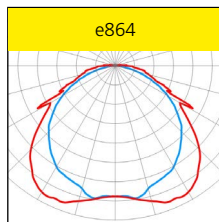

Product highlights:

- safety in case of an emergency, instant light with maximum light output
- operation in maintained, switched maintained or stand-by mode possible
- multifunctional LED with coded indication of the functions, states and potential faults of the electronic device and the battery
- automatic weekly function test
- automatic annual duration test
- manual actuation of duration test is possible
- easy battery replacement due to connector
- **innovative encapsulation** with high transmission rate
- **LED-Modules protected from mechanical or electrostatic damages** by sandwich design of reflector and cover
- **homogeneous illumination** by using **frosted diffusers** no individual light points visible, comfortable perception of light, brilliant glare limitation
- **high colour rendering index CRI > 80**, according to the workplace guide lines suitable for nearly all plant locations
- **FastFix mounting**, system for variable mounting distances and easy installation (retaining clips HK865 P) without opening the fitting
- **sustainable**, control gear and reflector with LED-modules replaceable by qualified personnel on-site

Properties, limitations and details for controlling LED-light fittings:

See "Technical Supplement"

All data are correct at the time of printing. Actual technical data can be found under www.schuch.de.

Article no.	Type	Connected load [W]	Luminous flux [lm]	Luminous flux [lm] (emergency)	Luminous efficacy [lm/W]	Cover frosted	Cover clear	Operating time 1 h	Operating time 3 h	Ta max [°C]	Substitute for *	Weight [kg] (without packing material)
-------------	------	--------------------	--------------------	--------------------------------	--------------------------	---------------	-------------	--------------------	--------------------	-------------	------------------	--

Note:

This light fitting is not suitable for applications in areas with permanent high humidity in combination with only short periods of operation, such as sewage or stormwater retention tanks or water treatment plants.

e864 06L... H

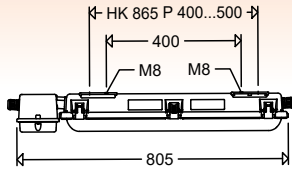

e864 12L...

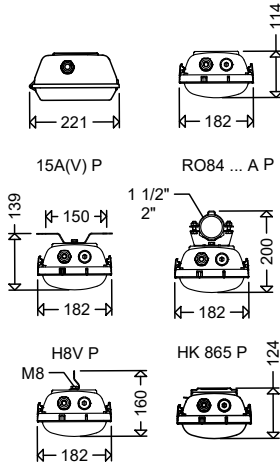
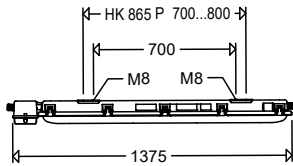

e864...



II 2 G Ex db eb mb q IIC T4 Gb	II 2 D Ex tb IIIC T80°C Db	IP66	
--------------------------------	----------------------------	------	--

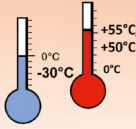

EU-Type Examination Certificate:

ATEX: IBExU 17 ATEX 1026X

Other approvals:

IECEX: IECEx IBE 17.0016X

Marking:

II 2 G Ex db eb mb q IIC T4 Gb (Zone 1)

II 2 D Ex tb IIIC T80°C Db (Zone 21)

Ignition protection: ec

Rated voltage: 220-240 V AC, 50/60 Hz.

Permissible ambient temperature:

-30 °C up to +55 °C

Normal range acc. to EN 60598-2-22 0 °C up to 45 °C, reduced emergency light duration if operated below 0 °C.

86405 0050	e864F 06L22/1/2	18	2.170	700	121	•	•	55	2 x 18W	6,2
86405 0052	e864F 06L42/1/2	29	4.100	700	141	•	•	50	2 x 36W	6,4
86405 0051	e864F 06L22/3/4	18	2.170	700	121	•	•	55	2 x 18W	6,4
86405 0053	e864F 06L42/3/4	29	4.100	700	141	•	•	50	2 x 36W	6,6
86405 0001	e864F 12L42/1/2	29	4.360	750	150	•	•	55	2 x 36W	7,6
86405 0002	e864F 12L60/1/2	41	6.020	750	147	•	•	55	2 x 58W	7,6
86405 0101	e864F 12L42/3/4	29	4.360	750	150	•	•	55	2 x 36W	8,0
86405 0102	e864F 12L60/3/4	41	6.020	750	147	•	•	55	2 x 58W	8,0

e864... DIMDI



II 2 G Ex db eb mb q IIC T4 Gb	II 2 D Ex tb IIIC T80°C Db	IP66	
--------------------------------	----------------------------	------	--

with monitoring and dimming function via DALI interface

Design:

As standard version, but with DALI interface for dimming and centralised monitoring.

Compatible with LIMAS Line PRO Light Management System.

Note:

The conducting wires to the control input must be mains voltage stable and can be integrated in the connection cable.

86405 0150	e864F 06L22/1/2 DIMDI	18	2.170	700	121	•	•	55	2 x 18W	6,2
86405 0152	e864F 06L42/1/2 DIMDI	29	4.100	700	141	•	•	50	2 x 36W	6,4
86405 0153	e864F 06L42/3/4 DIMDI	29	4.100	700	141	•	•	50	2 x 36W	6,6
86405 0003	e864F 12L42/1/2 DIMDI	29	4.360	750	150	•	•	55	2 x 36W	7,6
86405 0004	e864F 12L60/1/2 DIMDI	41	6.020	750	147	•	•	55	2 x 58W	7,6
86405 0103	e864F 12L42/3/4 DIMDI	29	4.360	750	150	•	•	55	2 x 36W	8,0
86405 0104	e864F 12L60/3/4 DIMDI	41	6.020	750	147	•	•	55	2 x 58W	8,0

* The given information is for rough orientation only. In each individual case a lighting calculation is necessary.

Accessories / Spare Parts

Article No.	Type	
Spare batteries		
90222 9023	Akku NiCd 1,6Ah 6,0V Block 8020	NiCd accu, 1.6 Ah 6.0V, Block for luminaire types ...H (pay attention to the correct part number)
90222 9021	Akku NiCd 4,0Ah 6,0V Block 2627	NiCd accu, 4.0 Ah 6.0V,Block for luminaire types ...H (pay attention to the correct part number).
90222 9035	Akku NiMH 2,2Ah 6,0V Block 8022	NiMH accu, 2.2 Ah 6.0V, Block for luminaire types ...H (pay attention to the correct part number)
90222 9036	Akku NiMH 4,0Ah 6,0V Block 8024	NiMH accu, 4.0 Ah 6.0V, Block for luminaire types ...H (pay attention to the correct part number)
Spare covers		
86601 9014	ABD 8652F	cover, frosted PC diffuser, for e864F 06 ..., e865F 06 ..., nD866F 06 ..., nD867F 06 ...
86601 9001	ABD 8654F	cover, frosted PC diffuser, for e864F 12 ..., e865F 12..., nD866F 12..., nD867F 12 ...
86601 9000	ABD 8654	cover, diffuser PC clear, for e864 12 ..., e865 12 ..., nD866 12 ..., nD867 12 ...
Fasteners		
90055 9004	KE/KES VE10	stainless steel, incl. 2 safety clips (packing unit 10 pcs.) see picture on the left, for e 864 12L.. until year of manufacture 2020
90055 9005	KES P	1 pair of safety clips stainless steel for e864 12L.. until year of manufacture 2020
90055 9007	KE/KES G2 VE10	stainless steel, incl. 2 safety clips (packing unit 10 pcs.) see picture on the left, for e 864 12L.. from year of manufacture 2020 and for e 864 06L..
90055 9006	KES G2 P	1 pair of safety clips stainless steel for e864 12L.. from year of manufacture 2020 and for e864 06L..
Glands/breather		
90117 9006	2537 G	ex-protected plastic cable gland M25 x 1,5 with locknut
90118 9006	2538 G	ex-protected plastic plug M25 x 1,5 with locknut
90119 9001	2539 G	ex-protected plastic cable gland M25 x 1,5 with blanking plug and locknut
90259 9000	KS25 G EX	ex-breather M25 x 1,5
Mounting material		
86501 9003	HK 865 P	2 retaining clips for variable mounting in indoor areas
90001 0002	H8V P	2 suspensions brackets, stainless steel
90000 0002	DS 15A P	2 ceiling brackets, hot galvanized steel
90032 0002	DS 15AV P	2 ceiling brackets, stainless steel
90037 0004	RO84 112 A P	2 pipe clamps 1 1/2", stainless steel, with support
90038 0004	RO84 2 A P	2 pipe clamps 2", stainless steel, with support
26000 0008	WW 26 L P	2 wall mounting angles, hot galvanized steel
26000 0002	WW 26 30 P	2 wall mounting angles 30°, hot galvanized steel
26000 0003	WW 26 45 P	2 wall mounting angles 45°, hot galvanized steel

Fasteners

KE/KES VE10
KES P



KE/KES G2 VE10
KES G2 P



LED-Light Fitting for Ex-Zone 1/2/1

Series e840...

Applications:

Hazardous locations of Zone 1/2 (gas) and 21/22 (dust) .

Design:

Housing: Glass fibre reinforced polyester resin.

Cover: Clear polycarbonate with internal prisms, hinged, silicone gasket.

Central locking system: Operated by a hexagonal socket wrench 13 mm.

Reflector: Aluminium, carrying the encapsu-

lated LED-modules with frosted covers for glare limitation, hingeable and removable.

Connection: 3 poles up to 4 mm².

Cable entries: 3 entries M25 x 1.5, (2 glands - one of them is plugged), PM-version: 1 x M20 x 1.5.

Standard: Facing downwards or forwards.

Mechanical installation:

Mounting accessories see spare parts/ accessories.

Technical Data:

LED: Line modules appr. 6,500 K, CRI > 80, service life L₈₀ > 100,000 h at max. ambient temperature, L₉₀ > 85,000 h (06L..) at 25 °C ambient temperature, L₉₀ > 75,000 h (12L..) at 25 °C ambient temperature

ECG: 220-240 V AC/DC, 0 or 50/60 Hz, overvoltage, overload and short circuit protection

Options:

- 4,500 K; light colour (845)
- through-wiring (DV)
- for higher ambient temperatures (H65), up to +65 °C
- for connection to central emergency supply systems (ZB)
- for connection to central emergency



supply systems with integrated monitoring module

- dimming function via DALI-2-compatible interface, can be combined with LIMAS Line Wired Light Management System (DIMD)

Note:

This light fitting is not suitable for application in areas with permanent high humidity in combination with only short periods of operation, such as sewage or stormwater retention tanks or water treatment plants.

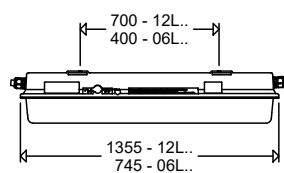

RO84 ... A P

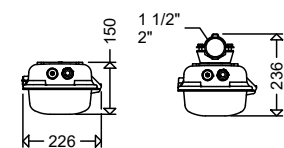

H8V P

15A(V) P

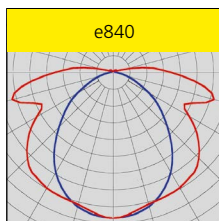
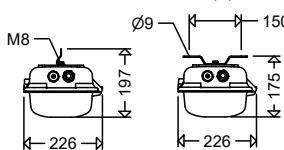

Product highlights:

- extremely robust construction of housing and diffuser
- comfortable central locking mechanism for easy maintenance
- **innovative encapsulation** with high transmission rate
- homogeneous lighting distribution by frosted anti-glare modules-protecting the LEDs as well of ESD and mechanical damage. No individual light points visible, comfortable perception of light, brilliant glare limitation.
- **high colour rendering index CRI > 80**, according to the workplace guide lines suitable for nearly all plant locations
- **sustainable**, control gear and reflector with LED-modules replaceable by qualified personnel on-site
- the light fittings are suitable for use in food areas (IFS/HACCP), see chapter 9.1 in the „Technical Supplement“



Looping the cable on one side:

All light fittings of series e840... have got 2 cable entries on one small side of the housing for cable looping instead of the through-wiring system.

Properties, limitations and details for controlling LED-light fittings:

See "Technical Supplement"

All data are correct at the time of printing. Actual technical data can be found under www.schuch.de.

Article no.	Type	Connected load [W]	Luminous flux [lm]	Luminous efficacy [lm/W]	Ta max [°C]	Substitute for *	Weight [kg] (without packing material)
-------------	------	--------------------	--------------------	--------------------------	-------------	------------------	--

e840...



II 2 G Ex eb mb op is q IIC T4 Gb

II 2 D Ex op is tb IIIC T80°C Db

IP66



EC-Type Examination Certificate:

ATEX: IBE XU 19 ATEX 1135

Other approvals:

IECEX: IECEx-Nr. IBE 19.0027

Ignition protection: eb

Marking:

II 2 G Ex eb mb op is q IIC T4 Gb (Zone 1)

II 2 D Ex op is tb IIIC T80°C Db (Zone 21)

Rated voltage: 220-240 V AC/DC, 0 or 50/60 Hz.

Permissible ambient temperature:

-25 °C up to see article table

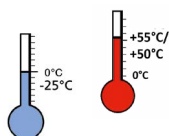

84005 0011	e840 06L22	16	2.054	128	55	2 x 18W	5,6
84005 0012	e840 06L42	28	4.067	145	55	2 x 36W	5,7
84005 0001	e840 12L42	28	4.230	151	55	2 x 36W	8,0
84005 0002	e840 12L60	40	5.850	146	55	2 x 58W	8,0
84005 0003	e840 12L85	54	8.300	154	50	> 2 x 58W	8,5

* The given information is for rough orientation only. In each individual case a lighting calculation is necessary.

Article no.	Type	Connected load [W]	Luminous flux [lm]	Luminous efficacy [lm/W]	Ta max [°C]	Substitute for *	Weight [kg] (without packing material)
-------------	------	--------------------	--------------------	--------------------------	-------------	------------------	--

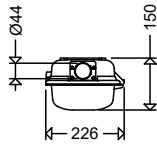
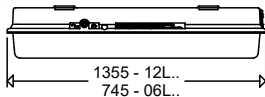

e840... PM



II 2 G Ex eb mb
op is q IIC T4 Gb

II 2 D Ex op is
tb IIIC T80°C Db

IP66



Pole mounted light fitting with integrated mounting system

EU-Type Examination Certificate:

ATEX: IBEU 19 ATEX 1135

Other approvals:

IECEX: IECEx-Nr. IBE 19.0027

Ignition protection: eb

Marking:

II 2 G Ex eb mb op is q IIC T4 Gb (Zone 1)

II 2 D Ex op is tb IIIC T80°C Db (Zone 21)

Rated voltage: 220-240 V AC/DC,
0 or 50/60 Hz

Mechanical installation: integrated mounting system 06L: Ø 42 x 150 mm (Length) 12L: Ø 42 x 245 mm (Length)

Permissible ambient temperature:
-25 °C up to see article table

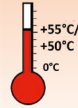

84005 0911	e840 06L22 PM	16	2.054	128	55	2 x 18W	7,9
84005 0912	e840 06L42 PM	28	4.067	145	55	2 x 36W	8,0
84005 0901	e840 12L42 PM	28	4.230	151	55	2 x 36W	8,1
84005 0902	e840 12L60 PM	40	5.850	146	55	2 x 58W	8,1
84005 0903	e840 12L85 PM	54	8.300	154	50	> 2 x 58W	8,7

* The given information is for rough orientation only. In each individual case a lighting calculation is necessary.



Accessories / Spare Parts

Article No.	Type	
Spare diffuser		
84001 9008	ABD 8402 SIL	cover, diffuser PC clear, silicone seal, for e840 06 ..., nD844 06... each up to year of manufacture 2017, in some cases also 2018/2019 (FA number required)
84001 9009	ABD 8402 SIL G	Cover, diffuser PC clear, silicone seal, for e840 06 ..., nD844 06... from year of manufacture 2020, in some cases also 2018/2019 (FA number required)
84001 9004	ABD 8404 SIL	cover, tray PC clear, silicone seal, for e840 12 ..., nD844 12 ..., 144 12 ...
Cable glands/breather		
90117 9006	2537 G	ex-protected plastic cable gland M25 x 1,5 with locknut
90118 9006	2538 G	ex-protected plastic plug M25 x 1,5 with locknut
90119 9001	2539 G	ex-protected plastic cable gland M25 x 1,5 with blanking plug and locknut
90259 9000	KS25 G EX	ex-breather M25 x 1,5
Mounting material		
90001 0002	H8V P	2 suspensions eyes with bolts, stainless steel
90000 0002	DS 15A P	2 ceiling brackets, hot galvanized steel
90032 0002	DS 15AV P	2 ceiling brackets, stainless steel
90000 0011	DW 84 AA P	1 pair of brackets, stainless steel, for compensating the different mounting distances of types e840 / e152 or e841 / e148
90037 0004	RO84 112 A P	2 pipe clamps 1 1/2", stainless steel, with support
90038 0004	RO84 2 A P	2 pipe clamps 2", stainless steel, with support
26000 0008	WW 26 L P	2 wall mounting angles, hot galvanized steel
26000 0002	WW 26 30 P	2 wall mounting angles 30°, hot galvanized steel
26000 0003	WW 26 45 P	2 wall mounting angles 45°, hot galvanized steel

Small LED-Light Fittings for Ex-Zone 1/21 Series e855...



Applications:

Hazardous areas in Zones 1/2 (gas) and 21/22 (dust) as standard illumination for small rooms and above doors, i.e. as information or escape route lighting with pictograms.

Design:

Housing: Glass fibre reinforced polyester resin.

Diffuser: Clear polycarbonate, frosted, detachable, silicone gasket.

Reflector: Sheet steel, painted white, detachable, carrying the encapsulated

LED-modules and protection cover.

Central locking system: Operated by a hexagonal box spanner 13 mm.

Connection: Prepared for looping the mains cable. Terminal L1+N+PE; up to 2.5 mm².

Cable entries: 2 entries M25 x 1.5 at one of the front side (2 cable glands, 1 with blanking plug).

Mounting: Stainless steel side mounting brackets allow direct wall or ceiling mounting.

Technical Data:

LED: Line modules appr. 6,500 K, CRI > 80, service life L₈₀ > 100,000 h at max. ambient temperature, L₉₀ > 95,000 h at 25°C ambient temperature

ECG: 220-240 V AC/DC, 0 or 50/60 Hz, overvoltage, overload and short circuit protection

Options:

- in/out wiring, 5-pole
- for connection to central emergency supply systems (ZB)
- for connection to central emergency supply systems with integrated monitoring module
- dimming function via DALI-2-compatible interface, can be combined with LIMAS Line wired Light Management System (DIMD)

Note:

This light fitting is not suitable for application in areas with permanent high humidity in combination with only short periods of operation, such as sewage or stormwater retention tanks or water treatment plants.

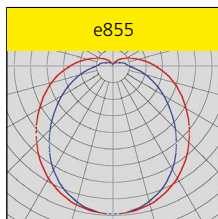
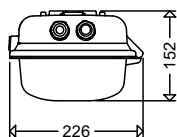
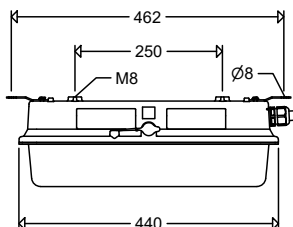

Product highlights:

- extremely robust construction of housing and diffuser
- comfortable central locking mechanism for easy maintenance
- innovative encapsulation with high transmission rate
- LED protecting cover against ESD and mechanical damage
- homogeneous illumination due to frosted covers on the reflector for glare limitation, no individual light points visible, comfortable perception of light, brilliant glare limitation
- high colour rendering index CRI > 80, according to the workplace guide lines suitable for nearly all plant locations
- sustainable, control gear and reflector with LED-modules replaceable by qualified personnel on-site



Article no.	Type	Connected load [W]	Luminous flux [lm]	Luminous efficacy [lm/W]	Suitable for pictogram	Ta max [°C]	Substitute for *	Weight [kg] (without packing material)
-------------	------	--------------------	--------------------	--------------------------	------------------------	-------------	------------------	--

e855...



II 2 G Ex eb mb q IIC T4 Gb

II 2 G Ex db eb mb q IIC T4 Gb

II 2 D Ex tb IIIC T80°C Db

IP66



EU-Type Examination Certificate:

IBExU 17 ATEX 1132X

Other approvals:

IECEx IBE 17.0037X

Type of protection: eb (increased safety)

Marking:

II 2 G Ex eb mb q IIC T4 Gb (Zone 1)

II 2 D Ex tb IIIC T80°C Db (Zone 21)

Rated Voltage: 220-240 V AC,

176-275 V DC, 50/60 Hz

Permissible ambient temperature:

-30 °C up to see article table

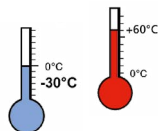

85500 0007	e855F L05	5	510	102		60	1 x 8W	5,0
85500 0001	e855F L10	10	1.060	106		60	2 x 8W	5,0
85500 0002	e855F L20	18	2.050	114		60	2 x 18W	5,1
85500 0003	e855F L10 DIMD	10	1.060	106		60	2 x 8W	5,0
85500 0004	e855F L20 DIMD	18	2.050	114		60	2 x 18W	5,1

* The given information is for rough orientation only. In each individual case a lighting calculation is necessary.

Properties, limitations and details for controlling LED-light fittings:

See "Technical Supplement"

All data are correct at the time of printing. Actual technical data can be found under www.schuch.de.

Article no.	Type	Connected load [W]	Luminous flux [lm]	Luminous efficacy [lm/W]	Suitable for pictogram	Ta max [°C]	Substitute for *	Weight [kg] (without packing material)
-------------	------	--------------------	--------------------	--------------------------	------------------------	-------------	------------------	---

e855... ZB		II 2 G Ex eb mb q II C T4 Gb	II 2 G Ex db eb mb q II C T4 Gb	II 2 D Ex tb IIIC T80°C Db	IP66	
-------------------	--	---------------------------------	------------------------------------	-------------------------------	------	--

for connection to central power supply unit

EU-Type Examination Certificate: IBExU 17 ATEX 1132X
 Other approvals: IECEx IBE 17.0037X
 Type of protection: eb (increased safety)
 Marking: II 2 G Ex eb mb q IIC T4 Gb (Zone 1)
 II 2 D Ex tb IIIC T80°C Db (Zone 21)

Rated Voltage: 220-240 V AC, 176-275 V DC, 50/60 Hz
 Permissible ambient temperature: -30 °C up to see article table

85500 0009	e855F L05 ZB	5	510	102	•	60	1 x 8W	5,0
------------	---------------------	---	-----	-----	---	----	--------	-----

* The given information is for rough orientation only. In each individual case a lighting calculation is necessary.



Photo: BASF



Type e855/... with pictogram PIK 121/33 W

Self-adhesive pictogram
green / transparent



PIK 121/32 W



PIK 121/33 W



PIK 121/34 W



PIK 121/35 W

For marking escape routes acc.to DIN EN ISO 7010 and ASR A1.3.

Viewing distance = 30 m

Accessories / Spare Parts

Article No.	Type	
Spare diffuser		
85501 9001	ABD 855	cover, diffuser PC frosted, silicone seal, for e855 ..., e856 ...
Cable entries/Glands/Breather		
90117 9006	2537 G	ex-protected plastic cable gland M25 x 1,5 with locknut
90118 9006	2538 G	ex-protected plastic plug M25 x 1,5 with locknut
90119 9000	2539 G	ex-protected plastic cable gland M25 x 1,5 with blanking plug and locknut
90259 9001	KS25 G EX	ex-breather M25 x 1,5
Mounting material		
90000 0002	DS 15A P	2 ceiling brackets, hot galvanized steel
90032 0002	DS 15AV P	2 ceiling brackets, stainless steel
90037 0004	RO84 112 A P	2 pipe clamps 1 1/2", stainless steel, with support
90038 0004	RO84 2 A P	2 pipe clamps 2", stainless steel, with support
26000 0008	WW 26 L P	2 wall mounting angles, hot galvanized steel
26000 0002	WW 26 30 P	2 wall mounting angles 30°, hot galvanized steel
26000 0003	WW 26 45 P	2 wall mounting angles 45°, hot galvanized steel
Self-adhesive pictograms		
12112 0013	PIK 121/32 W	emergency exit upstairs
12112 0006	PIK 121/33 W	emergency exit to the left
12112 0007	PIK 121/34 W	emergency exit to the right
12112 0008	PIK 121/35 W	emergency exit below



Small LED-Emergency Light Fitting for Ex-Zone 1/21 Series e856 ...

Applications:

Hazardous areas in Zones 1/2 (gas) and 21/22 (dust) as safety illumination e.g. for workstations with special hazard, i.e. as information or escape route lighting with pictogram for identification of escape routes.

Mechanical design:

Housing: Glass fibre reinforced polyester resin. Version H with separate battery box at one small side of the housing.

Diffuser: Clear polycarbonate, frosted, detachable, silicone gasket.

Reflector: Sheet steel, painted white, detachable, carrying the encapsulated

LED-modules and protection cover.

Central locking system: Operated by a hexagonal box spanner 13 mm.

Connection: Prepared for looping the mains cable at one end 4 x 1 - 4 mm². Terminal L1 + L1' + N + PE, up to 2.5 mm².

Cable entries: 2 entries M25 x 1.5 at the front side of the light fitting (2 cable glands, 1 with blanking plug).

Mounting: Stainless steel side mounting brackets allow direct wall or ceiling mounting (Version without battery box). Mounting accessories see spare parts/accessories.

Note:

This light fitting is not suitable for application in areas with permanent high humidity in combination with only short periods of operation, such as sewage or stormwater retention tanks or water treatment plants.

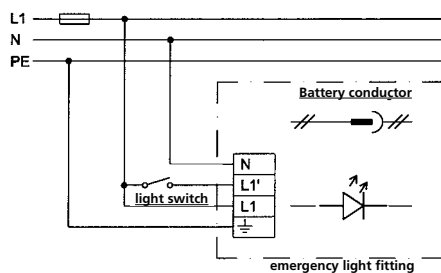

Starting:

Connect battery conductor

Out-of-operation: separate battery conductor

Stand-by operation: Do not connect L1'

Technical Data:

LED: Line modules ca. 6,500 K, CRI > 80, service life L₈₀ > 100,000 h at max. ambient temperature, L₉₀ > 95,000 h at 25 °C ambient temperature

ECG with emergency light electronic

Incorporated NiMH battery, electronic charger, short circuit protected battery and reverse battery protection

Electronic deep discharge protection: acc. to EN 61347-2-7

Re-charging time: 24 h, acc. to EN 60598-2-22

Automatic monitoring: of the emergency light fitting according to EN 62034, indication of the test results by 2-coloured LED (luminescence diode) at the luminaire

Mode of operation:

maintained operation = switching over to battery operation in case of mains failure, line modules will be operated with reduced luminous flux as emergency lighting.

stand-by operation = switching on in case of mains failure.

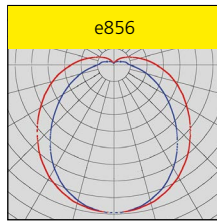

Options:

– in/out wiring, 6-pole

– remote switch-off device

e856F ... (without battery box)

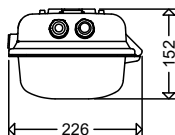
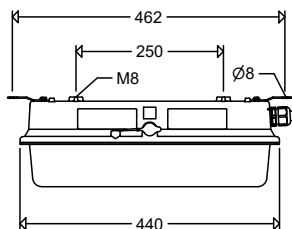

Product highlights:

- extremely robust construction of housing and diffuser
- comfortable central locking mechanism for easy maintenance
- **innovative encapsulation** with high transmission rate
- homogeneous lighting distribution by frosted anti-glare modules-protecting the LEDs as well of ESD and mechanical damage. No individual light points visible, comfortable perception of light, brilliant glare limitation
- **high colour rendering index CRI > 80**, according to the workplace guide lines suitable for nearly all plant locations
- safety in case of an emergency, instant light with maximum light output
- operation in maintained, switched maintained or stand-by mode possible
- multifunctional LED with coded indication of the functions, states and potential faults of the electronic device and the battery
- automatic weekly function test
- automatic annual duration test
- manual actuation of duration test is possible
- easy battery replacement due to connector
- **sustainable**, control gear and reflector with LED-modules replaceable by qualified personnel on-site



Properties, limitations and details for controlling LED-light fittings:

See "Technical Supplement"

All data are correct at the time of printing. Actual technical data can be found under www.schuch.de.



Photo: BASF

Article no.	Type	Connected load [W]	Luminous flux [lm]	Luminous flux [lm] (emergency)	Luminous efficacy [lm/W]	Suitable for pictogram	Operating time 1 h	Operating time 3 h	Ta max [°C]	Substitute for *	Weight [kg] (without packing material)
-------------	------	--------------------	--------------------	--------------------------------	--------------------------	------------------------	--------------------	--------------------	-------------	------------------	--

e856...



II 2 G Ex db eb
mb q IIC T4 Gb

II 2 D Ex tb IIIC
T80°C Db

IP66

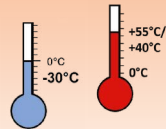

EU-Type Examination Certificate:

IBExU 17 ATEX 1132X

Other approvals:

IECEX IBE 17.0037X

Type of protection: eb (increased safety)

Marking:

II 2 G Ex db eb mb q IIC T4 Gb (Zone 1)

II 2 D Ex tb IIIC T80°C Db (Zone 21)

Rated voltage: 220-240 V AC, 50/60 Hz.

Permissible ambient temperature:

-30 °C up to +55 °C

Nominal range acc. to EN 60598-2-22

0 °C up to 40 °C or 55 °C (H-Versions).

Reduced emergency light duration if operated below 0 °C.

85605 0017	e856F L05/1/2	6	510	510	85	•	•	55	1 x 8W	5,4
85605 0018	e856F L05/3/2	6	510	260	85	•	•	55	1 x 8W	5,4
85605 0003	e856F L10/1/2	11	1.060	560	96	•	•	40	2 x 8W	5,4
85605 0004	e856F L10/3/2	11	1.060	260	96	•	•	40	2 x 8W	5,4
85605 0001	e856F L20/1/2	19	2.050	560	108	•	•	40	2 x 18W	5,5
85605 0002	e856F L20/3/2	19	2.050	260	108	•	•	40	2 x 18W	5,6

for high temperatures up to +55 °C

Design: Same as standard version, but with separate battery box at one small side of the housing.

85605 0007	e856F L10/1/2 H	11	1.060	560	96	•	•	55	2 x 8W	6,3
85605 0008	e856F L10/3/2 H	11	1.060	260	96	•	•	55	2 x 8W	6,3
85605 0005	e856F L20/1/2 H	19	2.050	560	108	•	•	55	2 x 18W	6,4
85605 0006	e856F L20/3/2 H	19	2.050	260	108	•	•	55	2 x 18W	6,5



e856F ... H (with battery box)

light fitting

battery box

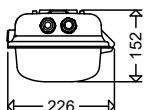
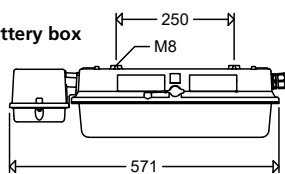

e856... DIMDI



II 2 G Ex db eb
mb q IIC T4 Gb

II 2 D Ex tb IIIC
T80°C Db

IP66



with monitoring and dimming function via DALI

Design:

As standard version, but with DALI interface for dimming and centralised monitoring.

Compatible with LIMAS Line PRO Light Management

System.

Note:

The conducting wires to the control input must be mains voltage stable and can be integrated in the connection cable.

85605 0019	e856F L05/1/2 DIMDI	6	510	510	85	•	•	55	1 x 8W	5,4
85605 0020	e856F L05/3/2 DIMDI	6	510	260	85	•	•	55	1 x 8W	5,4
85605 0023	e856F L10/1/2 DIMDI	11	1.060	560	96	•	•	40	2 x 8W	5,4
85605 0024	e856F L10/3/2 DIMDI	11	1.060	260	96	•	•	40	2 x 8W	5,4
85605 0011	e856F L20/1/2 DIMDI	19	2.050	560	108	•	•	40	2 x 18W	5,5
85605 0022	e856F L20/3/2 DIMDI	19	2.050	260	108	•	•	40	2 x 18W	5,6

* The given information is for rough orientation only. In each individual case a lighting calculation is necessary.



Type e856/... with pictogram PIK 121/33 W

Self-adhesive pictogram
green / transparent

PIK 121/32 W



PIK 121/33 W



PIK 121/34 W



PIK 121/35 W

For marking escape routes acc.to DIN EN ISO 7010 and ASR A1.3.

Viewing distance = 30 m

Accessories / Spare Parts

Article No.	Type	
Spare batteries		
90222 9023	Akku NiCd 1,6Ah 6,0V Block 8020	NiCd accu, 1.6Ah 6.0V Block 8020 (pay attention to the correct part number)
90222 9024	Akku NiCd 2,5Ah 6,0V Block 8021	NiCd accu, 2.5Ah 6.0V Block 8021 (pay attention to the correct part number)
90222 9035	Akku NiMH 2,2Ah 6,0V Block 8022	NiMH accu, 2.2Ah 6.0V, Block for luminaire types ...H (pay attention to the correct part number)
Spare diffuser		
85501 9001	ABD 855	cover, diffuser PC frosted, silicone seal, for e855 ..., e856 ...
Cable entries/Glands/Breather		
90117 9006	2537 G	ex-protected plastic cable gland M25 x 1,5 with locknut
90118 9006	2538 G	ex-protected plastic plug M25 x 1,5 with locknut
90119 9001	2539 G	ex-protected plastic cable gland M25 x 1,5 with blanking plug and locknut
90259 9000	KS25 G EX	ex-breather M25 x 1,5
Mounting material		
90000 0002	DS 15A P	2 ceiling brackets, hot galvanized steel
90032 0002	DS 15AV P	2 ceiling brackets, stainless steel
90037 0004	RO84 112 A P	2 pipe clamps 1 1/2", stainless steel, with support
90038 0004	RO84 2 A P	2 pipe clamps 2", stainless steel, with support
26000 0008	WW 26 L P	2 wall mounting angles, hot galvanized steel
26000 0002	WW 26 30 P	2 wall mounting angles 30°, hot galvanized steel
26000 0003	WW 26 45 P	2 wall mounting angles 45°, hot galvanized steel
Self-adhesive pictograms		
12112 0013	PIK 121/32 W	emergency exit upstairs
12112 0006	PIK 121/33 W	emergency exit to the left
12112 0007	PIK 121/34 W	emergency exit to the right
12112 0008	PIK 121/35 W	emergency exit below

LED-Steep roof light fitting for Ex-Zone 1/21 Series e821...



Applications:

Hazardous areas of Zones 1 (gas) and 21 (dust), e.g. cleanrooms, paint shops and spray booths.

Design:

Housing: Sheet steel, powder coated in light grey (RAL 7035), silicone foam gasket.

Glass cover: Impact resistant safety glass pane, frameless / hinged.

Central locking system: Operated by a 5mm allen key, internal hinges on the opposite side.

Reflector: Hinged; white painted sheet steel; detachable, carrying the encapsulated LED-modules and glare limitation modules.

Connection: 3 poles up to 4 mm².

Cable entries: 3 x M25 x 1.5 (2 glands - one of them is plugged and 1 screw plug).

Standard: Facing downwards or forwards.

Mechanical installation:

Mounting accessories see spare parts/ accessories.

Technical Data:

LED: Line modules appr. 6,500 K, CRI > 80, service life L₈₀ > 100,000 h at max. ambient temperature, L₉₀ > 80,000 h at 25 °C ambient temperature

ECG: 220-240 V AC/DC, 0 or 50/60 Hz, overvoltage, overload and short circuit protection

Note:

This light fitting is not suitable for application in areas with permanent high humidity in combination with only short periods of operation, such as sewage or stormwater retention tanks or water treatment plants.

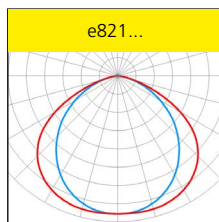
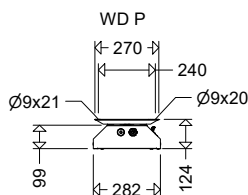
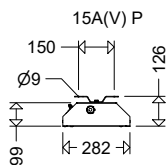
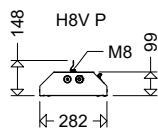
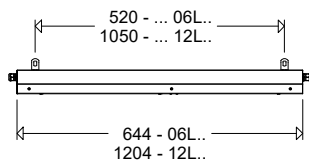

Options:

- 4,500 K; light colour (845)
- through-wiring (DV)
- stainless steel version (E.), painted
- for higher ambient temperatures (H65), up to +65 °C
- for installation in thermally insulated ceilings in accordance with EN 60598



- for connection to central emergency supply systems (ZB)
- for connection to central emergency supply systems with integrated monitoring module

Product highlights:

- extremely flat and robust design
- innovative LED encapsulation with high transmission rate
- perfect protection of the LED from mechanical or electrostatic damages with at the same time homogeneous illumination with glare limitation modules, no individual light points visible, comfortable perception of light, excellent glare limitation
- high colour rendering index CRI > 80, according to the workplace guide lines suitable for nearly all plant locations
- comfortable central locking system with internal hinges
- separate, frame for recessed installation or a swivel arm mounting system can easily be installed at a later stage, (frame for recessed installation not suitable for stainless steel version!)
- sustainable, control gear and reflector with LED-modules replaceable by qualified personnel on-site
- suitability for paint booths LABS-tested according to VDMA 24364-C2-L



Article no.	Type	Connected load [W]	Luminous flux [lm]	Luminous efficacy [lm/W]	Ta max [°C]	Substitute for *	Weight [kg] (without packing material)
-------------	------	--------------------	--------------------	--------------------------	-------------	------------------	--

Looping the cable on one side:

All light fittings of series e821... have got 2 cable entries on one small side of the housing for cable looping instead of the through wiring system. (3-pole looping standard, 5-pole looping at additional cost)

Properties, limitations and details for controlling LED-light fittings:

- See "Technical Supplement"

All data are correct at the time of printing. Actual technical data can be found under www.schuch.de.

e821...

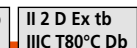
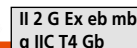

EU-Type Examination Certificate:

IBExU 20 ATEX 1017

Other approvals:

IECEx IBE 19.0032

Ignition protection: eb

Marking:

II 2 G Ex eb mb q IIC T4 Gb (Zone1)

II 2 D Ex tb IIIC T80°C Db (Zone 21)

Rated voltage: 220-240 V AC/DC, 0 or 50/60 Hz.

Permissible ambient temperature: -30 °C up to +55 °C

The values given are for versions with through-wiring.

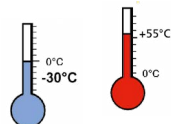

82100 0001	e821 06L22	15	2.100	140	55	2 x 18W	9,1
82100 0002	e821 06L42	28	4.110	147	55	2 x 36W	9,4
82100 0003	e821 06L60	40	5.600	140	55	2 x 58W	9,4
82100 0050	e821 12L42	28	4.260	152	55	2 x 36W	14,8
82100 0051	e821 12L60	40	5.900	148	55	2 x 58W	14,8
82100 0052	e821 12L85	54	8.350	155	55	> 2 x 58W	15,7
82100 0053	e821 12L120	79	11.470	145	55	> 3 x 58W	15,7

* The given information is for rough orientation only. In each individual case a lighting calculation is necessary.

Article no.	Type	Connected load [W]	Luminous flux [lm]	Luminous efficacy [lm/W]	Ta max [°C]	Substitute for *	Weight [kg] (without packing material)
-------------	------	--------------------	--------------------	--------------------------	-------------	------------------	--

e821... DIMD

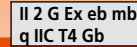

dimnable via DALI interface

Design:

Same as standard version, but with DALI-2-compatible ECG and 2 additional clamping points, marked with DA. Compatible with LIMAS Line BASIC/PRO Light Management System.

Note:

The conducting wires to the control input must be mains voltage stable and can be integrated in the connection cable.

82100 0005	e821 06L42 DIMD	28	4.110	147	55	2 x 36W	9,4
82100 0006	e821 06L60 DIMD	40	5.600	140	55	2 x 58W	9,4
82100 0054	e821 12L42 DIMD	28	4.260	152	55	2 x 36W	14,8
82100 0055	e821 12L60 DIMD	40	5.900	148	55	2 x 58W	14,8
82100 0056	e821 12L85 DIMD	54	8.350	155	55	> 2 x 58W	15,7
82100 0057	e821 12L120 DIMD	79	11.470	145	55	> 3 x 58W	15,7

* The given information is for rough orientation only. In each individual case a lighting calculation is necessary.

Installation dimensions

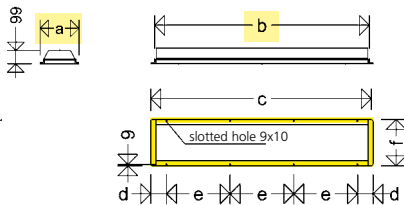

Type	a	b	c	d	e	f
EB 82. 06L	302	660	710	55	300	348
EB 82. 12L	302	1224	1270	125	340	348

Attention: When planning the opening for recess installation please allow additional clearance for the cable glands.

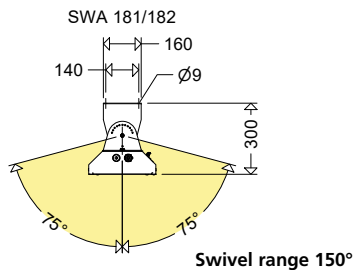
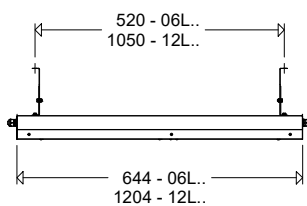

Further accessories as well as carrier rail systems and through-wiring systems are available.

Frame for Recessed Installation

retrofit possible!

Light fittings of series e821... can be fitted with a surrounding angled frame for ceiling and wall installation (also retrofitted, except for stainless steel versions).

Mounting by means of M5 bolts to the long sides of the housing (see drawing).

Article No.	Type	
18091 0020	EB 82. 06L	frame for narrow housing, e821 06L, nD822 06L
18091 0021	EB 82. 12L	frame for narrow housing, e821 12L, nD822 12L

Swivel Arm Mounting System

retrofit possible!

Light fittings of series e821... can be equipped with a swivel arm mounting system at any time. The swivel arms are fixed to the suspen-

sion points at the upper side of the housing. Swivel range: $\pm 75^\circ$ (see dimensions in diagram).

Article No.	Type	
18092 0001	SWABF 181/182 P	for all wattages consisting of: 2 swivel arms with bolts M8

Accessories / Spare Parts

Article No.	Type	
Spare glasses		
82101 9001	ABD 821 06	cover, spare safety glass clear, for 185 06 ..., e821 06 ..., nD822 06 ...
82101 9002	ABD 821 12	cover, spare safety glass clear, for 185 12 ..., e821 12 ..., nD822 12 ...
Cable entries/cable glands		
90117 9006	2537 G	ex-protected plastic cable gland M25 x 1,5 with locknut
90119 9001	2539 G	ex-protected plastic cable gland M25 x 1,5 with locknut and plug
90118 9006	2538 G	ex-protected plastic plug M25 x 1,5 with locknut
Mounting material		
90001 0002	H8V P	2 suspension eyes, stainless steel
90000 0002	DS 15A P	2 ceiling brackets, hot galvanized steel
90032 0002	DS 15AV P	2 ceiling brackets, stainless steel
26000 0011	WDW P	2 wall/ceiling angle, painted steel
26000 0005	WDW 45 P	2 wall/ceiling angle 45°, painted steel

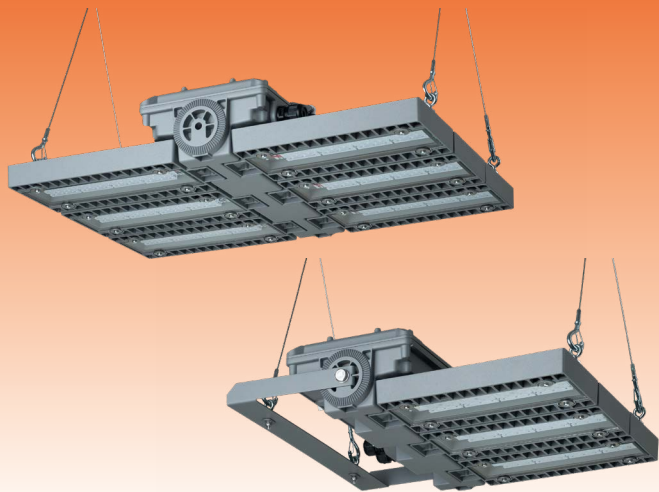

ExSTREAM LED High Bay Fitting for Ex-Zone 1/2/1 Series e8825...

Applications:

Hazardous areas of Zones 1 (gas) and 21 (dust), in production, assembly and storage halls, workshops, the chemical - petrochemical and pharmaceutical industries, mills, paper mills, etc.

Design:

Available in 2 versions:

With three or six LED modules.

Housing: Die-cast aluminum, multi-part, thermally separated, powder-coated DB 702 (mica-iron paint, grey). **LED housing** with LED modules, optics and

safety glass. **Device housing** with built-in control gear, wired ready for connection.

Front cover: Thermally resistant safety glass, impact resistance IK08.

Optics: Lens optics with narrow, narrow-wide or wide beam light distribution, Multi-Layer technology.

Connection: 5 poles, max. clamping range 4 mm².

Cable entries: 2 x M25 x 1.5 (2 glands - one of them is plugged)

Mounting: see accessories (4 eyelets included)

Technical Data:

LED-module: approx. 5,500 K (TB- and B-optics) or approx. 6,500 K (T-optics), CRI > 80, service life L₈₀ > 100,000 h at max. ambient temperature, L₉₀ > 90,000 h at 25 °C ambient temperature

ECG: 220 - 240 V AC/DC, 0 or 50/60 Hz, overvoltage, overload and short circuit protection.

Ambient temperature: -30 °C up to +40 °C/+55 °C (see article tables)

Options:

– for lower ambient temperatures (T40), down to -40 °C

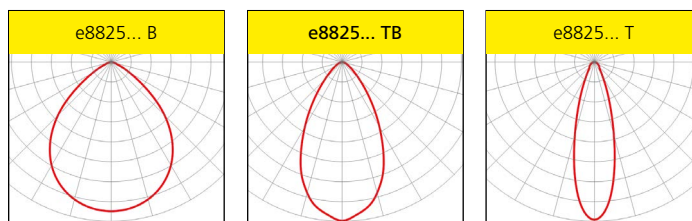

e8825/3...

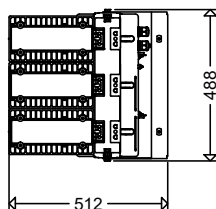
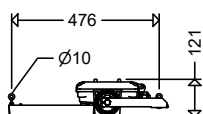

e8825/6...

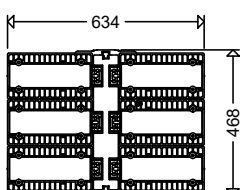
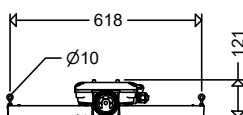

Product highlights:

- **robust, modular design**
- **highly efficient** due to the use of high quality MID-Power LEDs
- **extremely long service life** even at maximum permissible ambient temperature
- **optimized thermal management**
 - direct mounting of the LED modules to the housing
 - separate housings for ECG- and LED-modules
 - LED housing with integrated cooling fin structure
 - large cooling surface, excellent heat dissipation, very good convection
- **colour rendering index CRI > 80**, according to the workplace guide lines suitable for nearly all plant locations
- **homogeneous and effective light distribution** by specially calculated lens optics
- **sustainable**, control gear and LED-housing with LED-module replaceable by qualified personnel on-site

Properties, limitations and details for controlling LED-light fittings:

See "Technical Supplement"

All data are correct at the time of printing. Actual technical data can be found under www.schuch.de.

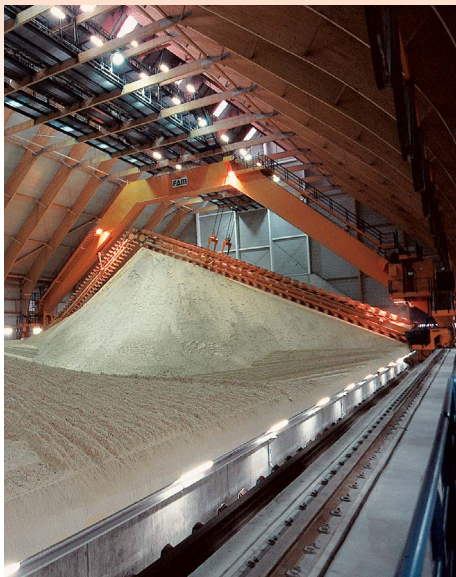

Photo: BASF

Article no.	Type	Connected load [W]	Luminous flux [lm]	Luminous efficacy [lm/W]	Ta max [°C]	Weight [kg] (without packing material)
-------------	------	--------------------	--------------------	--------------------------	-------------	---

Note:

This light fitting is not suitable for application in areas with permanent high humidity in combination with only short periods of operation, such as sewage or stormwater retention tanks or water treatment plants.



e8825...



II 2 G Ex eb
mb q IIC T4 Gb

II 2 D Ex tb IIIC
T100 °C Db

IP66



EU-Type Examination Certificate:

ATEX: IBEU 20 ATEX 1117

Other approvals:

IECEX: IECEx IBE 20.0028

Ignition protection: eb

Marking:

II 2 G Ex eb mb q IIC T4 Gb (Zone 1)

II 2 D Ex tb IIIC T100 °C Db (Zone 21)

Rated voltage: 220 V up to 240 V AC/DC,
0 or 50/60 Hz

Permissible ambient temperature:

-30 °C up to see article tables

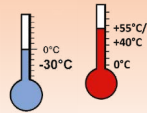

wide beam

88250 0001	e8825/3 L120B H55	87	11.850	136	55	8,8
88250 0004	e8825/3 L150B	125	15.800	126	40	8,8
88250 0007	e8825/6 L240B H55	174	23.700	136	55	13,5
88250 0010	e8825/6 L300B	250	31.600	126	40	13,5

narrow wide beam

88250 0002	e8825/3 L120TB H55	87	11.100	128	55	8,8
88250 0005	e8825/3 L150TB	125	14.650	117	40	8,8
88250 0008	e8825/6 L240TB H55	174	22.200	128	55	13,5
88250 0011	e8825/6 L300TB	250	29.300	117	40	13,5

narrow beam

88250 0003	e8825/3 L120T H55	87	10.300	118	55	8,8
88250 0006	e8825/3 L150T	125	13.500	108	40	8,8
88250 0009	e8825/6 L240T H55	174	20.600	118	55	13,5
88250 0012	e8825/6 L300T	250	27.000	108	40	13,5

e8825... DIMD



II 2 G Ex eb
mb q IIC T4 Gb

II 2 D Ex tb IIIC
T100 °C Db

IP66



dimmable via DALI interface

Design:

Same as standard version, but with DALI-2-compatible ECG and 2 additional clamping points, marked with DA. Compatible with LIMAS Line BASIC/PRO Light Management System.

Note:

The conducting wires to the control input must be mains voltage stable and can be integrated in the connection cable.

wide beam

88250 0100	e8825/3 L120B H55 DIMD	87	11.850	136	55	8,8
88250 0103	e8825/3 L150B DIMD	125	15.800	126	40	8,8
88250 0106	e8825/6 L240B H55 DIMD	174	23.700	136	55	13,5
88250 0109	e8825/6 L300B DIMD	250	31.600	126	40	13,5

narrow wide beam

88250 0101	e8825/3 L120TB H55 DIMD	87	11.100	128	55	8,8
88250 0104	e8825/3 L150TB DIMD	125	14.650	117	40	8,8
88250 0107	e8825/6 L240TB H55 DIMD	174	22.200	128	55	13,5
88250 0110	e8825/6 L300TB DIMD	250	29.300	117	40	13,5

narrow beam

88250 0102	e8825/3 L120T H55 DIMD	87	10.300	118	55	8,8
88250 0105	e8825/3 L150T DIMD	125	13.500	108	40	8,8
88250 0108	e8825/6 L240T H55 DIMD	174	20.600	118	55	13,5
88250 0111	e8825/6 L300T DIMD	250	27.000	108	40	13,5

Mounting material

Y-ropes 3301/3302 Y P



Ceiling brackets steel DW 8825 P



Accessories / Spare Parts

Article no.	Type	
Cable glands		
90117 9000	2537	ex-protected plastic cable gland M25 x 1,5
90119 9000	2539	ex-protected plastic cable gland M25 x 1,5 with plug
Mounting material		
33001 9004	3301/3302 Y P	1 pair of Y-ropes, (2-point-mounting) For indoor use only.
26000 0010	DW 8825 P	1 pair of ceiling brackets steel, powder-coated DB 702

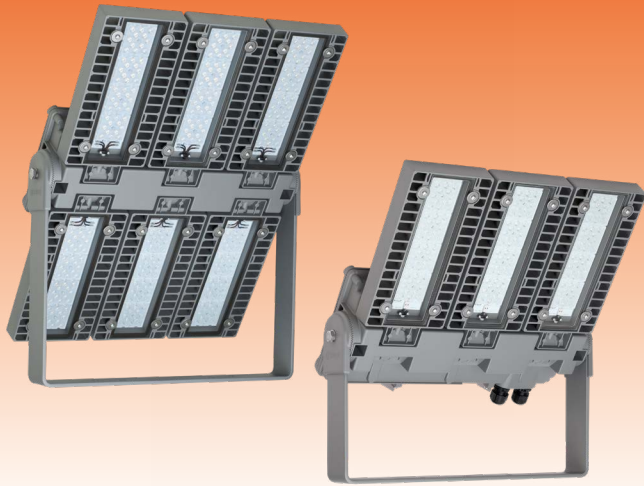

ExSTREAM LED-Floodlight for Ex-Zone 1/21 Series e8820...

Applications:

Hazardous areas of Zones 1 (gas) and 21 (dust). Oil and gas industry, onshore and offshore, chemical, petrochemical and pharmaceutical plants, refineries, tank farms, loading stations, etc.

Design:

Available in 2 versions:

With three or six LED modules.

Housing: Die-cast aluminum, multi-part, thermally separated, powder-coated DB 702 (mica-iron paint, grey). **LED housing** with LED modules, optics and safety glass. **Device housing** with built-in control gear, wired ready for connection.

Front cover: Thermally resistant safety glass, impact resistance IK08.

Optics: Lens optics with narrow, narrow-wide or wide beam light distribution, Multi-Layer technology.

Connection: 5 poles, max. clamping range 4 mm².

Cable entries: 2 x M25 x 1.5 (2 glands - one of them is plugged)

Mounting: Stainless steel bracket, adjustable in 5° steps around the longitudinal axis of the floodlight.

Standard Mounting: Light beam downwards or horizontally.

e8820/3...

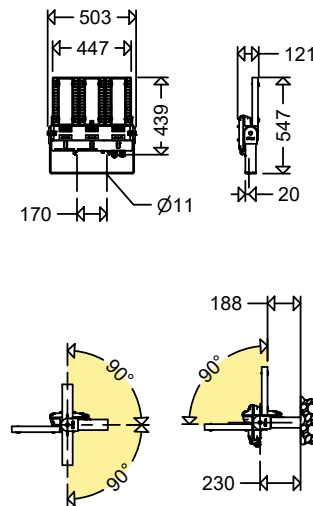

e8820/6...

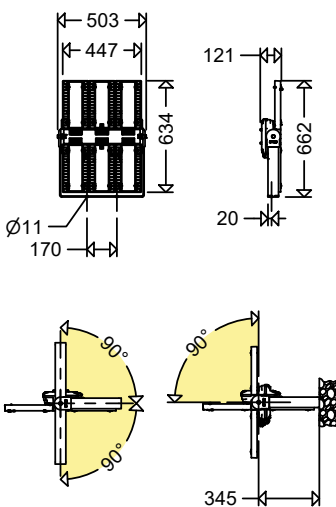

Technical Data:

LED-module: approx. 5,500 K (TB- and B-optics) or approx. 6,500 K (T-optics), CRI > 80, service life L₈₀ > 100,000 h at max. ambient temperature, L₉₀ > 90,000 h at 25 °C ambient temperature

ECG: 220 - 240 V AC/DC, 0 or 50/60 Hz, overvoltage, overload and short circuit protection.

Ambient temperature: -30 °C up to +40 °C/+55 °C (see article tables)

Options:

– for lower ambient temperatures (T40),
down to -40 °C

– seawater-resistant version

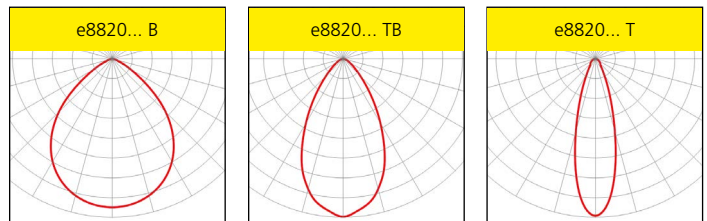

Product highlights:

- robust, modular design
- highly efficient due to the use of high quality MID-Power LEDs
- extremely long service life even at maximum permissible ambient temperature
- optimized thermal management
 - direct mounting of the LED modules to the aluminum housing
 - separate housings for ECG- and LED-modules
 - LED housing with integrated cooling fin structure
 - large cooling surface, excellent heat dissipation, very good convection
- colour rendering index CRI > 80, according to the workplace guide lines suitable for nearly all plant locations
- homogeneous and effective light distribution by specially calculated lens optics
- inclination angle adjustable in 5° steps
- sustainable, control gear and LED-housing with LED-module replaceable by qualified personnel on-site
- eco-friendly friendly with 0° installation, no light emission into the upper half-space, Dark-Sky requirements are fulfilled



Photo: BASF

Properties, limitations and details for controlling LED-light fittings:

See "Technical Supplement"

All data are correct at the time of printing. Actual technical data can be found under www.schuch.de.

Article no.	Type	Connected load [W]	Luminous flux [lm]	Luminous efficacy [lm/W]	Ta max [°C]	Weight [kg] (without packing material)
-------------	------	--------------------	--------------------	--------------------------	-------------	--

Note:

This light fitting is not suitable for application in areas with permanent high humidity in combination with only short periods of operation, such as sewage or stormwater retention tanks or water treatment plants.



e8820...



II 2 G Ex eb mb q IIC T4 Gb

II 2 D Ex tb IIIC T100 °C Db

IP66

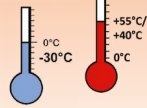
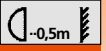

EU-Type Examination Certificate:

ATEX: IBEU 20 ATEX 1117

Other approvals:

IECEX: IIECEX IBE 20.0028

Ignition protection: eb

Marking:

II 2 G Ex eb mb q IIC T4 Gb (Zone 1)

II 2 D Ex tb IIIC T100 °C Db (Zone 21)

Rated voltage: 220 V up to 240 V AC/DC, 0 or 50/60 Hz

Permissible ambient temperature:

-30 °C up to see article tables

wide beam

88200 001	e8820/3 L120B H55	87	11.850	136	55	11,2
88200 004	e8820/3 L150B	125	15.800	126	40	11,2
88200 007	e8820/6 L240B H55	174	23.700	136	55	17,2
88200 010	e8820/6 L300B	250	31.600	126	40	17,2

narrow wide beam

88200 002	e8820/3 L120TB H55	87	11.100	128	55	11,2
88200 005	e8820/3 L150TB	125	14.650	117	40	11,2
88200 008	e8820/6 L240TB H55	174	22.200	128	55	17,2
88200 011	e8820/6 L300TB	250	29.300	117	40	17,2

narrow beam

88200 003	e8820/3 L120T H55	87	10.300	118	55	11,2
88200 006	e8820/3 L150T	125	13.500	108	40	11,2
88200 009	e8820/6 L240T H55	174	20.600	118	55	17,2
88200 012	e8820/6 L300T	250	27.000	108	40	17,2

e8820... DIMD



II 2 G Ex eb mb q IIC T4 Gb

II 2 D Ex tb IIIC T100 °C Db

IP66



dimmable via DALI interface

Design:

Same as standard version, but with DALI-2-compatible ECG and 2 additional clamping points, marked with DA. Compatible with LIMAS Line BASIC/PRO Light Management System.

Note:

The conducting wires to the control input must be mains voltage stable and can be integrated in the connection cable.

wide beam

88200 0100	e8820/3 L120B H55 DIMD	87	11.850	136	55	11,2
88200 0103	e8820/3 L150B DIMD	125	15.800	126	40	11,2
88200 0106	e8820/6 L240B H55 DIMD	174	23.700	136	55	17,2
88200 0109	e8820/6 L300B DIMD	250	31.600	126	40	17,2

narrow wide beam

88200 0101	e8820/3 L120TB H55 DIMD	87	11.100	128	55	11,2
88200 0104	e8820/3 L150TB DIMD	125	14.650	117	40	11,2
88200 0107	e8820/6 L240TB H55 DIMD	174	22.200	128	55	17,2
88200 0110	e8820/6 L300TB DIMD	250	29.300	117	40	17,2

narrow beam

88200 0102	e8820/3 L120T H55 DIMD	87	10.300	118	55	11,2
88200 0105	e8820/3 L150T DIMD	125	13.500	108	40	11,2
88200 0108	e8820/6 L240T H55 DIMD	174	20.600	118	55	17,2
88200 0111	e8820/6 L300T DIMD	250	27.000	108	40	17,2

Single mounting: MAU 1 76/170 M10

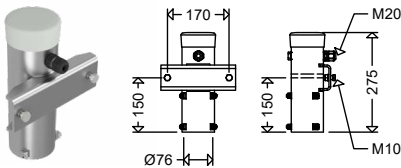

Double mounting: MAU 2 76/170 M10

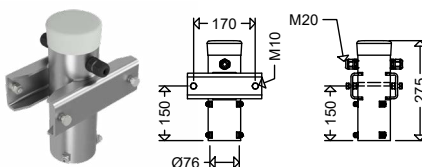

Accessories / Spare Parts

Article no.	Type	
Cable glands		
90117 9000	2537	ex-protected plastic cable gland M25 x 1,5
90119 9000	2539	ex-protected plastic cable gland M25 x 1,5 with plug
Mounting material		
75739 9001	MAU 1 76/170 M10	Pole top for single mounting, ø 76 mm, galvanized steel
75739 9002	MAU 2 76/170 M10	Pole top for double mounting, ø 76 mm, galvanized steel



ExGLOBE

LED-Ceiling- or Wall-mounting light fitting for Ex-Zones 1/21 Series e9312

Applications:

Hazardous locations of zones 1 (gas) and 21 (dust) with low requirements for illuminance, strained field conditions or hard to reach areas.

Design:

Housing: Diecast aluminium, unpainted
Electrical kit: Diecast aluminium, with LED-Module and integrated ECG.
Cover: Polycarbonate, frosted.

Wire guard (SK): Galvanized steel.

Connection:

3 pole terminal, max. connection range 2,5 mm².

Cable entry system:

2 x M25 x 1.5 (1 gland and 1 plug).

Mounting: 2 cast on brackets for wall or ceiling mounting

Operating position: Any method except.

Technical Data:

LED: approx. 6,500 K, CRI typically 80, service life L₇₀ > 100,000 h at max. ambient temperature

Rated voltage: 220-240 V AC/DC, 0 or 50/60 Hz

Admissible ambient temperature: -25 °C up to +40 °C

Options:

– cable gland 2 x M25 x 1.5

Product highlights:

- robust, corrosion-resistant housing
- outer screws and bolts made of stainless steel
- shock resistant PC-cover
- additional safety due to robust wire guard (SK)
- homogeneous illumination by using frosted cover, no particular light points visible, comfortable perception of light, brilliant glare limitation
- wide range of admissible ambient temperature -25 °C up to +40 °C
- easy mounting with outer fixing points
- sustainable, control gear with LED-module replaceable by qualified personnel on-site

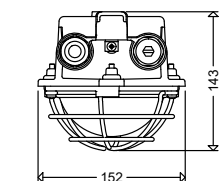
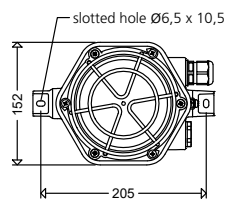
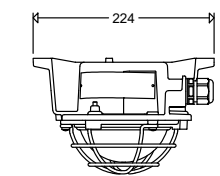
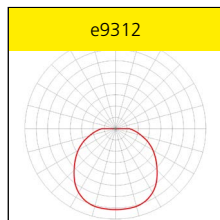
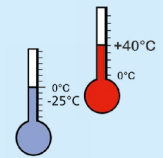

Article no.	Type	Connected load [W]	Luminous flux [lm]	Luminous efficacy [lm/W]	Weight [kg] (without packing material)
-------------	------	--------------------	--------------------	--------------------------	--

e9312



EU-Type Examination Certificate:

IBExU 20 ATEX 1092

Other approvals:

IECEx IBE 20.0013

Marking:

II2G Ex eb mb IIC T4 Gb (Zone 1)

II2D Ex tb IIIC T80°C Db (Zone 21)

Ignition protection: „e“ (increased safety)

93120 0001	e9312F SK	11	600	55	1,3
93120 0002	e9312F	11	600	55	1,2

Properties, limitations and details for controlling LED-light fittings:

See "Technical Supplement"

All data are correct at the time of printing. Actual technical data can be found under www.schuch.de.

Accessories / Spare Parts

Article no.	Type	
93101 9000	ABD 9309F	cover, frosted PC diffuser, silicone seal, for e9312 ...
93101 9001	SK 930 A	spare wire guard
90117 9000	2537	plastic gland M25 x 1,5
90118 9000	2538	plastic plug M25 x 1,5



ExSPECT LED hand lamp for Ex-Zones 1/21 Series e9310

Applications:

For use as work lighting in hazardous areas of Zones 1, 2 and 21, 22 which cannot be illuminated by any general lighting equipment.

Design:

Handle: Made of rubber (EPDM), with suspension eye, cable relief, cable entry

M20 x 1.5 mm² with bend protection.

Electrical kit: Diecast aluminium, with LED-Module and integrated ECG.

Cover: Polycarbonate, frosted

Wire guard: Round steel, cage hook for suspension purpose.

Operating position: Any method except.

Technical Data:

LED: approx. 6,500 K, CRI typically 80, service life L₇₀ > 100,000 h at max. ambient temperature

Rated voltage: 220 - 240 V AC/DC, 0 or 50/60 Hz

Admissible ambient temperature: -25 °C up to +40 °C

Product highlights:

- robust design for reliable and safe long-term use
- sturdy handhold
- shock resistant PC-cover
- additional safety due to robust wire guard
- high degree of protection IP66 (dust-proof and jet-proof)
- user-friendly and for various applications
- light weight
- suspension eye and cage hook
- homogeneous illumination by using frosted cover, no particular light points visible, comfortable perception of light, brilliant glare limitation
- ATEX-certified for gas and dust hazardous areas (Zones 1/21 and 2/22)
- ATEX-certified for explosion group II C and temperature class T4
- wide range of admissible ambient temperature from -25 °C to +40 °C
- sustainable, control gear with LED-module replaceable by qualified personnel on-site

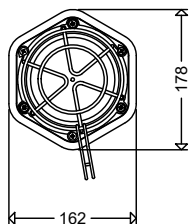
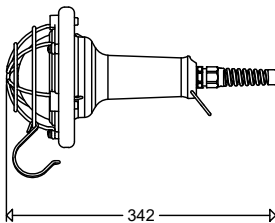
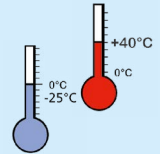
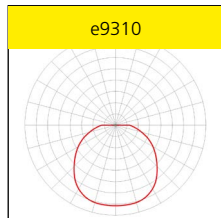

Article no.	Type	Connected load [W]	Luminous flux [lm]	Luminous efficacy [lm/W]	Weight [kg] (without packing material)
-------------	------	--------------------	--------------------	--------------------------	--

e9310



II 2G Ex eb
mb IIC T4 Gb

II 2D Ex tb
IIIC T80°C Db

IP66



EU-Type Examination Certificate:

IBExU 19 ATEX 1134

Other approvals:

IECEx IBE 19.0028

Marking:

II 2G Ex eb mb IIC T4 Gb (Zone 1)

II 2D Ex tb IIIC T80°C Db (Zone 21)

Ignition protection: „e“ (increased safety)

93100 0001	e9310F	11	600	55	1,3
------------	--------	----	-----	----	-----

Properties, limitations and details for controlling LED-light fittings:

See "Technical Supplement"

All data are correct at the time of printing. Actual technical data can be found under www.schuch.de.

Accessories / Spare Parts

Article no.	Type	
93101 9003	ABD 9308F	cover, frosted PC diffuser, for e9310 ...
93101 9004	SK 930 B	spare wire guard, with suspension hook
93101 9002	93KT	cable gland with bend protection

ExeLED 2 LED-Light Fitting for Ex-Zones 2/22 Series nD866...

Applications:

Hazardous locations of zones 2 (gas) and 22 (dust).

Design:

Housing: Glass fibre reinforced polyester resin.

Cover: Injected polycarbonate, frosted (F), silicone gasket.

Closure: Stainless steel clips (KE), two of them as safety clip (KES), to be opened with screwdriver only.

Reflector: Sheet Steel, painted, carrying the

LED-modules and all electrical components, clipped into the cover, suspendable.

Connection: 3 poles up to 2.5 mm².

Cable entries: 3 entries M25 x 1.5,

(2 glands - one of them is plugged)

Standard: Facing downwards or forwards.

Mechanical installation:

Direct ceiling mounting is possible. Rubber washers are included

Further mounting options see accessories / spare parts.

Technical Data:

LED: Line modules 5,000 K, CRI > 80, service life L₈₀ > 100,000 h at max. ambient temperature, L₉₀ > 80,000 h (06L..) at 25 °C ambient temperature, L₉₀ > 90,000 h (12L..) at 25 °C ambient temperature

ECG: 220-240 V AC/DC, 0 or 50/60 Hz, overvoltage, overload and short circuit protection

Options:

– 3,000 K; light colour (830)

– through-wiring (DV)

– for lower ambient temperatures (T40), down to -40 °C

– for connection to central emergency supply systems (ZB)



– for connection to central emergency supply systems with integrated monitoring module

Note:

This light fitting is not suitable for application in areas with permanent high humidity in combination with only short periods of operation, such as sewage or stormwater retention tanks or water treatment plants.

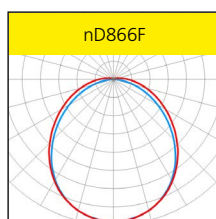
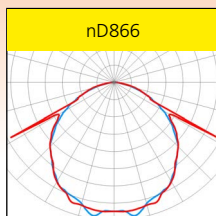

Product highlights:

- Reflector and cover in sandwich design to protect the LED-Modules from mechanical or electrostatic damages due to accidental contact
- homogeneous illumination by using frosted diffusers no individual light points visible, comfortable perception of light, brilliant glare limitation
- high colour rendering index CRI > 80, according to the workplace guide lines suitable for nearly all plant locations
- FastFix mounting, system for variable mounting distances and easy installation (retaining clips HK865 P) without opening the fitting
- sustainable, control gear and reflector with LED-modules replaceable by qualified personnel on-site
- the light fittings are suitable for use in food areas (IFS/HACCP), see chapter 9.1 in the „Technical Supplement“



Looping the cable on one side:

All light fittings of series nD866... have got 2 cable entries on one small side of the housing for cable looping instead of the through-wiring system.

Properties, limitations and details for controlling LED-light fittings:

See "Technical Supplement"

All data are correct at the time of printing. Actual technical data can be found under www.schuch.de.





Pole mount with pipe clamps RO84P

nD866 06L...

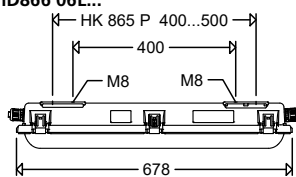

nD866 12L...

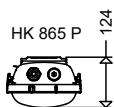
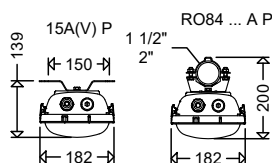
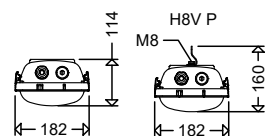
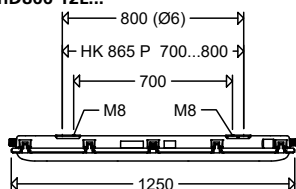

Article no.	Type	Connected load [W]	Luminous flux [lm]	Luminous efficacy [lm/W]	Cover frosted	Cover clear	Ta max [°C]	Substitute for *	Weight [kg] (without packingmaterial)
-------------	------	--------------------	--------------------	--------------------------	---------------	-------------	-------------	------------------	---------------------------------------

nD866...

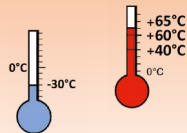
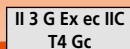

Type Examination Certificate:

IBExU 16 ATEX B006X

Other approvals:

IECEX IBE 15.0015X

Ignition protection: ec

Marking:

II 3 G Ex ec IIC T4 Gc (Zone 2)

II 3 D Ex tc IIIC T80°C Dc (Zone 22)

Rated voltage: 220-240 V AC/DC, 0 or 50/60 Hz.

Permissible ambient temperature:

-30 °C see article table

86600 0050	nD866F 06L22	15	2.170	145	•	40	2 x 18W	3,3
86600 0051	nD866F 06L42	28	4.120	147	•	40	2 x 36W	3,4
86600 0052	nD866F 06L60	40	5.700	143	•	40	2 x 58W	3,4
86600 0002	nD866F 12L42	28	4.360	156	•	40	2 x 36W	5,4
86600 0003	nD866F 12L60	40	6.020	151	•	40	2 x 58W	5,4
86600 0004	nD866F 12L85	54	8.620	160	•	40	> 2 x 58W	5,5

nD866... DIMD

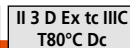
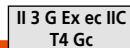

dimmable via DALI interface

Design:

Same as standard version, but with DALI-2-compatible ECG and 2 additional clamping points, marked with DA. Compatible with LIMAS Line BASIC/PRO Light Management System.

Note:

The conducting wires to the control input must be mains voltage stable and can be integrated in the connection cable.

86600 0951	nD866F 06L42 DIMD	28	4.120	147	•	40	2 x 36W	3,4
86600 0953	nD866F 06L60 DIMD	40	5.700	143	•	40	2 x 58W	3,4
86600 0018	nD866F 12L42 DIMD	28	4.360	156	•	40	2 x 36W	5,4
86600 1903	nD866F 12L60 DIMD	40	6.020	151	•	40	2 x 58W	5,4
86600 0904	nD866F 12L85 DIMD	54	8.620	160	•	40	> 2 x 58W	5,5

nD866... H..

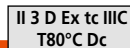
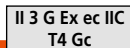

for high temperature ¹⁾

86600 0005	nD866F 12L42 H65	28	4.360	156	•	65	2 x 36W	5,4
86600 0008	nD866F 12L60 H60	40	6.020	151	•	60	2 x 58W	5,4

* The given information is for rough orientation only. In each individual case a lighting calculation is necessary.

¹⁾ through-wiring or looping the cable is not permissible.

Versions up to Ta 55 °C (H55) also possible with in/out wiring and through-wiring.

Explosion protected Light Fittings

Fasteners

KE/KES VE10
KES P



KE/KES G2 VE10
KES G2 P



Pipe clamps

2 pipe clamps 1 1/2",
stainless steel, with
support



2 pipe clamps 2",
stainless steel, with
support



Accessories / Spare Parts

Article No.	Type	
Spare covers		
86601 9014	ABD 8652F	cover, frosted PC diffuser, for e864F 06 ..., e865F 06 ..., nD866F 06 ..., nD867F 06 ...
86601 9001	ABD 8654F	cover, frosted PC diffuser, for e864F 12 ..., e865F 12..., nD866F 12..., nD867F 12 ...
86601 9000	ABD 8654	cover, diffuser PC clear, for e864 12 ..., e865 12 ..., nD866 12 ..., nD867 12 ...
Fasteners		
90055 9004	KE/KES VE10	stainless steel, incl. 2 safety clips (packing unit 10 pcs.) see picture on the left, for nD866 12L.. until year of manufacture 2020
90055 9005	KES P	1 pair of safety clips stainless steel for nD866 12L.. until year of manufacture 2020
90055 9007	KE/KES G2 VE10	stainless steel, incl. 2 safety clips (packing unit 10 pcs.) see picture on the left, for nD866 12L.. from year of manufacture 2020 and for nD866 06L..
90055 9006	KES G2 P	1 pair of safety clips stainless steel for nD866 12L.. from year of manufacture 2020 and for nD866 06L..
Glands/breather		
90117 9006	2537 G	ex-protected plastic cable gland M25 x 1,5 with locknut
90118 9006	2538 G	ex-protected plastic plug M25 x 1,5 with locknut
90119 9001	2539 G	ex-protected plastic cable gland M25 x 1,5 with blanking plug and locknut
90259 9000	KS25 G EX	ex-breather M25 x 1,5
Mounting material		
86501 9003	HK 865 P	2 retaining clips for variable mounting in indoor areas
90001 0002	H8V P	2 suspensions eyes with bolts, stainless steel
90000 0002	DS 15A P	2 ceiling brackets, hot galvanized steel
90032 0002	DS 15AV P	2 ceiling brackets, stainless steel
90037 0004	RO84 112 A P	2 pipe clamps 1 1/2", stainless steel, with support also for pole mounting
90038 0004	RO84 2 A P	2 pipe clamps 2", stainless steel, with support also for pole mounting
26000 0008	WW 26 L P	2 wall mounting angles, hot galvanized steel
26000 0002	WW 26 30 P	2 wall mounting angles 30°, hot galvanized steel
26000 0003	WW 26 45 P	2 wall mounting angles 45°, hot galvanized steel



ExeLED 2 N LED-Emergency Light Fitting for Ex-Zones 2/22 Series nD867...

Applications:

Hazardous locations of zones 2 (gas) and 22 (dust) for illumination of escape routes.

Design:

Housing: Glass fibre reinforced polyester resin. Version H with separate battery box at one small side of the housing.

Cover: Injected polycarbonate, frosted (F), silicone gasket.

Closure: Stainless steel clips (KE), two of them as safety clip (KES), to be opened with screwdriver only.

Reflector: Sheet Steel, painted, carrying the

LED-modules and all electrical components, clipped into the cover, suspendable.

Connection: 4 poles up to 2,5 mm².

Cable entries: 3 entries M25 x 1,5, (2 glands - one of them is plugged). Versions H with 2 x M25 x 1,5 at the front end of the light fitting.

Standard: Facing downwards or forwards.

Mechanical installation:

Direct ceiling mounting is possible. Rubber washers are included. Further mounting options see accessories / spare parts.

Note:

This light fitting is not suitable for application in areas with permanent high humidity in combination with only short periods of operation, such as sewage or stormwater retention tanks or water treatment plants.

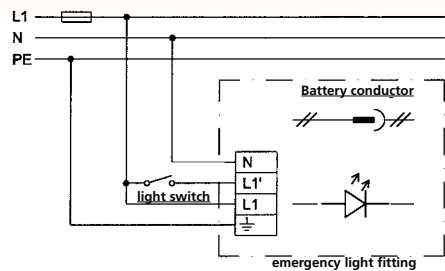

Starting:

Connect battery conductor

Out-of-operation: separate battery conductor

Stand-by operation: Do not connect L1'

Technical Data:

LED: Line modules 5,000 K, CRI > 80, service life L₈₀ > 100,000 h at max. ambient temperature, L₉₀ > 90,000 h (06L..) at 25 °C ambient temperature, L₉₀ > 75,000 h (12L..) at 25 °C ambient temperature

Incorporated NiMH battery, electronic charger, short circuit protected battery and reverse battery protection

Electronic deep discharge protection: acc. to EN 61347-2-7

Re-charging time: 24 h, acc. to EN 60598-2-22

Automatic monitoring: of the emergency light fitting according to EN 62034, indication of the test results by 2-coloured LED (luminescence diode) at the luminaire

Mode of operation:

maintained operation = switching over to battery operation in case of mains failure, line modules will be operated with reduced luminous flux as emergency lighting.

stand-by operation = switching on in case of mains failure.

Options:

- in-out wiring, 6-pole

- 3,000 K; light colour (830)

- through-wiring (DV)

- remote switch-off device

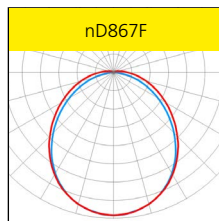
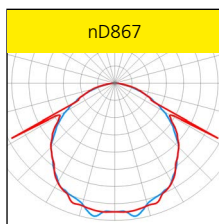

nD867... 06L.. (without battery box)

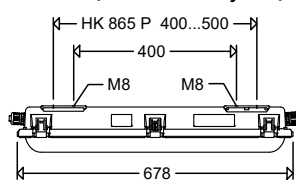

nD867... 12L.. (without battery box)

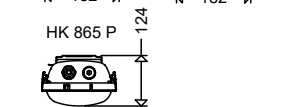
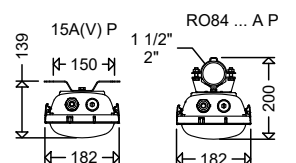
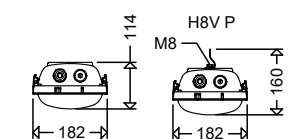
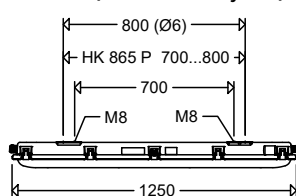

Product highlights:

- safety in case of an emergency, instant light with maximum light output
- operation in maintained, switched maintained or stand-by mode possible
- multifunctional LED with coded indication of the functions, states and potential faults of the electronic device and the battery
- automatic weekly function test
- automatic annual duration test
- manual actuation of duration test is possible
- easy battery replacement due to connector
- Reflector and cover in sandwich design to protect the LED-Modules from mechanical or electrostatic damages due to accidental contact
- homogeneous illumination by using frosted diffusers no individual light points visible, comfortable perception of light, brilliant glare limitation
- high colour rendering index CRI > 80, according to the workplace guide lines suitable for nearly all plant locations
- FastFix mounting, system for variable mounting distances and easy installation (retaining clips HK865 P) without opening the fitting
- sustainable, control gear and reflector with LED-modules replaceable by qualified personnel on-site

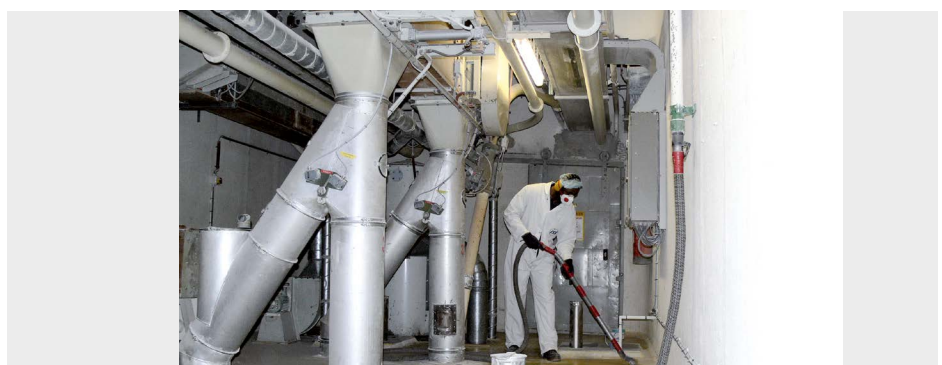

Properties, limitations and details for controlling LED-light fittings:

See "Technical Supplement"

All data are correct at the time of printing. Actual technical data can be found under www.schuch.de.

Article no.	Type	Connected load [W]	Luminous flux [lm]	Luminous flux [lm] (emergency)	Luminous efficacy [lm/W]	Cover frosted	Cover clear	Operating time 1 h	Operating time 3 h	Ta max [°C]	Substitute for *	Weight [kg] (without packing material)
-------------	------	--------------------	--------------------	--------------------------------	--------------------------	---------------	-------------	--------------------	--------------------	-------------	------------------	--

nD867...

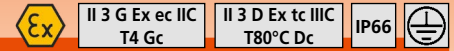

Type Examination Certificate:

IBExU 16 ATEX B006X

Other approvals:

IECEx IBE 15.0015X

Ignition protection: ec

Marking:

II 3 G Ex ec IIC T4 Gc (Zone 2)

II 3 D Ex tc IIIC T80°C Dc (Zone 22)

Rated voltage: 220-240 V AC, 50/60 Hz.

Permissible ambient temperature:

-30 °C up to see table, reduced emergency light duration if operated below 0 °C. For nD867 H nominal range acc. to EN60598-2-22, 0 °C up to 45 °C.

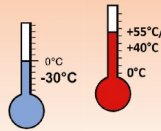

86705 0050	nD867F 06L22/1/4	16	2.170	650	136	•	•	•	40	2 x 18W	4,2
86705 0052	nD867F 06L42/1/4	29	4.360	750	150	•	•	•	40	2 x 36W	4,4
86705 0003	nD867F 12L42/1/4	29	4.360	750	150	•	•	•	40	2 x 36W	6,3
86705 0004	nD867F 12L60/1/4	41	6.020	750	147	•	•	•	40	2 x 58W	6,3
86705 0051	nD867F 06L22/3/4	16	2.170	650	136	•	•	•	40	2 x 18W	4,2
86705 0053	nD867F 06L42/3/4	29	4.360	750	150	•	•	•	40	2 x 36W	4,4
86705 0101	nD867F 12L42/3/4	29	4.360	750	150	•	•	•	40	2 x 36W	6,3
86705 0102	nD867F 12L60/3/4	41	6.020	750	147	•	•	•	40	2 x 58W	6,3

** versions L60 with through-wiring Tmax +35°C

nD867... H



for high temperatures up to +55 °C

Design:

Same as standard version, but with separate battery box at one small side of the housing.

86705 0250	nD867F 06L22/1/4 H	16	2.170	650	136	•	•	•	55	2 x 18W	5,2
86705 0252	nD867F 06L42/1/4 H	29	4.360	750	150	•	•	•	55	2 x 36W	5,4
86705 0203	nD867F 12L42/1/4 H	29	4.360	750	150	•	•	•	55	2 x 36W	7,3
86705 0204	nD867F 12L60/1/4 H	41	6.020	750	147	•	•	•	55	2 x 58W	7,3
86705 0251	nD867F 06L22/3/4 H	16	2.170	650	136	•	•	•	55	2 x 18W	5,2
86705 0253	nD867F 06L42/3/4 H	29	4.360	750	150	•	•	•	55	2 x 36W	5,4
86705 0301	nD867F 12L42/3/4 H	29	4.360	750	150	•	•	•	55	2 x 36W	7,3
86705 0302	nD867F 12L60/3/4 H	41	6.020	750	147	•	•	•	55	2 x 58W	7,3

nD867... DIMDI



with monitoring and dimming function via DALI interface

Design:

As standard version, but with DALI interface for dimming and centralised monitoring.

Compatible with LIMAS Line PRO Light Management System.

Note:

The conducting wires to the control input must be mains voltage stable and can be integrated in the connection cable.

86705 0150	nD867F 06L22/1/4 DIMDI	16	2.170	650	136	•	•	•	40	2 x 18W	4,2
86705 0152	nD867F 06L42/1/4 DIMDI	29	4.360	750	150	•	•	•	40	2 x 36W	4,4
86705 0115	nD867F 12L42/1/4 DIMDI	29	4.360	750	150	•	•	•	40	2 x 36W	6,3
86705 0005	nD867F 12L60/1/4 DIMDI	41	6.020	750	147	•	•	•	40	2 x 58W	6,3
86705 0151	nD867F 06L22/3/4 DIMDI	16	2.170	650	136	•	•	•	40	2 x 18W	4,2
86705 0153	nD867F 06L42/3/4 DIMDI	29	4.360	750	150	•	•	•	40	2 x 36W	4,4
86705 0114	nD867F 12L42/3/4 DIMDI	29	4.360	750	150	•	•	•	40	2 x 36W	6,3
86705 0119	nD867F 12L60/3/4 DIMDI	41	6.020	750	147	•	•	•	40	2 x 58W	6,3

* The given information is for rough orientation only. In each individual case a lighting calculation is necessary.



nD867 06L... H (with battery box)

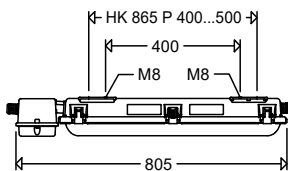

nD867 12L... H (with battery box)

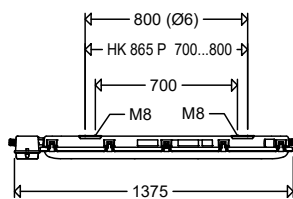

battery box

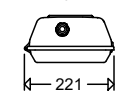

light fitting

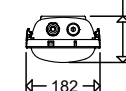

Accessories / Spare Parts

Article No.	Type	
Spare batteries		
90222 9031	Akku NiCd 6V 4,0Ah Stab	NiCd accu, 6.0 V 4.0 Ah, stick; replacement for article no. 90222_9029 (pay attention to the correct part number)
90222 9030	Akku NiCd 6V 1,6Ah Stab	NiCd accu, 6.0 V 1.6 Ah, stick (pay attention to the correct part number)
90222 9034	Akku NiMH 6V 4,0Ah Stab	NiMH accu, 6.0 V 4.0 Ah, stick (pay attention to the correct part number)
90222 9021	Akku NiCd 6V 4,0Ah Block 2627	NiCd accu, 6.0 V 4.0 Ah, Block for luminaire types ...H (pay attention to the correct part number)
90222 9023	Akku NiCd 6V 1,6Ah Block 8020	NiCd accu, 6.0 V 1.6 Ah, Block for luminaire types ...H (pay attention to the correct part number)
90222 9036	Akku NiMH 6V 4,0Ah Block 8024	NiMH accu, 6.0 V 4.0 Ah, Block for luminaire types ...H (pay attention to the correct part number)
Spare covers		
86601 9014	ABD 8652F	cover, frosted PC diffuser, for e864F 06 ..., e865F 06 ..., nD866F 06 ..., nD867F 06 ...
86601 9001	ABD 8654F	cover, frosted PC diffuser, for e864F 12 ..., e865F 12..., nD866F 12..., nD867F 12 ...
86601 9000	ABD 8654	cover, diffuser PC clear, for e864 12 ..., e865 12 ..., nD866 12 ..., nD867 12 ...
Fasteners		
90055 9004	KE/KES VE10	stainless steel, incl. 2 safety clips (packing unit 10 pcs.) see picture on the left, for nD867 12L.. until year of manufacture 2020
90055 9005	KES P	1 pair of safety clips stainless steel for nD867 12L.. until year of manufacture 2020
90055 9007	KE/KES G2 VE10	stainless steel, incl. 2 safety clips (packing unit 10 pcs.) see picture on the left, for nD867 12L.. from year of manufacture 2020 and for e nD867 06L..
90055 9006	KES G2 P	1 pair of safety clips stainless steel for nD867 12L.. from year of manufacture 2020 and for nD867 06L..
Glands/breather		
90117 9006	2537 G	ex-protected plastic cable gland M25 x 1,5 with locknut
90118 9006	2538 G	ex-protected plastic plug M25 x 1,5 with locknut
90119 9001	2539 G	ex-protected plastic cable gland M25 x 1,5 with blanking plug and locknut
90259 9000	KS25 G EX	ex-breather M25 x 1,5
Mounting material		
86501 9003	HK 865 P	2 retaining clips for variable mounting in indoor areas
90001 0002	H8V P	2 suspensions eyes with bolts, stainless steel
90000 0002	DS 15A P	2 ceiling brackets, hot galvanized steel
90032 0002	DS 15AV P	2 ceiling brackets, stainless steel
90037 0004	RO84 112 A P	2 pipe clamps 1 1/2", stainless steel, with support
90038 0004	RO84 2 A P	2 pipe clamps 2", stainless steel, with support
26000 0008	WW 26 L P	2 wall mounting angles, hot galvanized steel
26000 0002	WW 26 30 P	2 wall mounting angles 30°, hot galvanized steel
26000 0003	WW 26 45 P	2 wall mounting angles 45°, hot galvanized steel

Fasteners

KE/KES VE10
KES P



KE/KES G2 VE10
KES G2 P



Compact LED Emergency and Escape Sign Light Fitting for Ex-Zones 2/22 Series nD8611... LED



Applications:

Hazardous locations of zones 2 (gas) and 22 (dust) for illumination of escape routes and for identification of escape routes.

Design:

Housing: Die-cast aluminium, natural finish, all electrical components integrated in the housing, wired ready for connection.

Cover: Polycarbonate opalescent white, (W), foamed silicone gasket. (Pictograms –

if required – to be ordered separately, see accessories).

Connection terminal: 3 or 4 poles, clamping range max. 2.5 mm².

Cable entries: 1 cable gland M20 x 1.5 on the front side.

Mounting: 2 outer fixing points.

Technical Data:

LED: Linear module 6,500 K, CRI > 80, service life L₈₀ > 70,000 h at max. ambient temperature

Versions with self-contained battery:

Built-in NiMH battery. A constant trickle charge to the battery ensures readiness of operation at all times.

Automatic monitoring the emergency light fitting acc. to EN 62034. Indication of the test results by 2-colour LED on the light fitting.

Electronic deep discharge protection acc. to EN 61347-2-7

Recharging time: 24 h, acc. to EN 60598-2-22

Modes of operation:

Stand-by operation: Emergency light switches on in case of mains failure

Maintained operation: Switching over to battery operation in case of mains failure

Options:

- cable looping at 1 small side, two entries on one side
- for higher ambient temperatures (H60), up to +60 °C
- for connection to central emergency supply systems with integrated monitoring module



For series with self-contained battery:

- dimming function via DALI-2 interface, compatible with LIMAS Line Pro or Line ESC wired Light Management Systems

Note:
This light fitting is not suitable for application in areas with permanent high humidity in combination with only short periods of operation, such as sewage or stormwater retention tanks or water treatment plants.

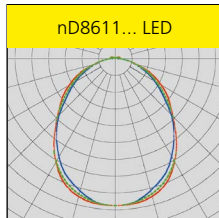
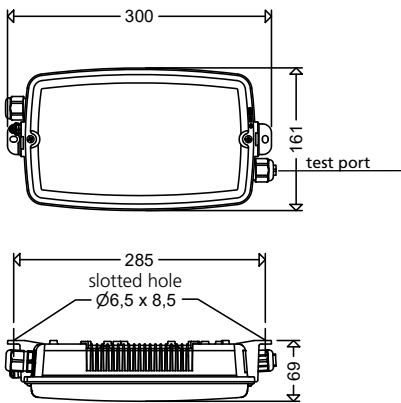

Product highlights:

- safety in case of an emergency, instant light with maximum light output
- **stable luminous flux in emergency operation** independent from the ambient temperatures
- **outstanding visibility of the indication sign** due to a superb and even illumination of the pictogram
- robust light fitting for rough environment
- perfect by strained field conditions
- **homogeneous illumination by using opal diffusers**, comfortable perception of light
- fast mounting through external mounting grounding clips
- **sustainable**, control gear and LED-module replaceable by qualified personnel on-site

Article no.	Type	Connected load [W]	Luminous flux [lm]	Luminous flux [lm] (emergency)	Luminous efficacy [lm/W]	Light fitting for pictogram	Operating time 1 h	Operating time 3 h	Weight [kg] (without packing material)
-------------	------	--------------------	--------------------	--------------------------------	--------------------------	-----------------------------	--------------------	--------------------	--

nD8611 L02/. W



II 3 G Ex nR IIC T4 Gc

II 3 D Ex tc IIIC T80°C Dc

IP65



self-contained emergency luminaire

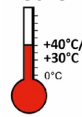
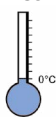

Ignition protection: nR

Explosion protection:

II 3 G Ex nR IIC T4 Gc Gc (Zone 2)

II 3 D Ex tc IIIC T80°C Dc (Zone 22)

Rated voltage: 220-240 V AC, 50/60 Hz

Ambient temperature:

0 °C bis +30 °C (maintained operation)

0 °C bis +40 °C (standby operation)

86111 0010	nD8611 L02/1 W	5	150	150	30	•	•	•	1,0
86111 0011	nD8611 L02/3 W	5	150	150	30	•	•	•	1,2

Properties, limitations and details for controlling LED-light fittings:

See "Technical Supplement"

All data are correct at the time of printing. Actual technical data can be found under www.schuch.de.

Article no.	Type	Connected load [W]	Luminous flux [lm]	Luminous flux [lm] (emergency)	Luminous efficacy [lm/W]	Light fitting for pictogram	Operating time 1 h	Operating time 3 h	Weight [kg] (without packing material)
-------------	------	--------------------	--------------------	--------------------------------	--------------------------	-----------------------------	--------------------	--------------------	--

nD8611 L02 W



II 3 G Ex nR IIC T4 Gc

II 3 D Ex tc IIIC T80°C Dc

IP65

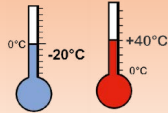

Ignition protection: nR

Rated voltage: 220-240 V AC, 50/60 Hz

Explosion protection:

Ambient temperature:

II 3 G Ex nR IIC T4 Gc Gc (Zone 2)

-20 °C up to +40 °C

II 3 D Ex tc IIIC T80°C Dc (Zone 22)

(further versions upon request).

86110 0010	nD8611 L02 W	4	150		38				0,8
------------	--------------	---	-----	--	----	--	--	--	-----

nD8611 L02 W ZB



II 3 G Ex nR IIC T4 Gc

II 3 D Ex tc IIIC T80°C Dc

IP65

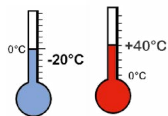

Ignition protection: nR

Rated voltage: 220-240 V AC/DC,

Explosion protection:

0 or 50/60 Hz

II 3 G Ex nR IIC T4 Gc Gc (Zone 2)

Ambient temperature:

II 3 D Ex tc IIIC T80°C Dc (Zone 22)

-20 °C up to +40 °C

(further versions upon request).

86111 0013	nD8611 L02 W ZB	4	150	150	38	•			0,8
------------	-----------------	---	-----	-----	----	---	--	--	-----

for connection to central power supply unit

Explosion protected Light Fittings



Type nD8611/... with pictogram PIK 220/110/33

Self-adhesive pictogram

green / transparent



PIK 220/110/32



PIK 220/110/33



PIK 220/110/34



PIK 220/110/35

For marking escape routes acc.to DIN EN ISO 7010 and ASR A1.3.

Viewing distance = 22 m

Accessories / Spare Parts

Article no.	Type	
Spare cover		
36004 9002	ABD 3611 W	cover, diffuser PC opal, for 3611 ..., nD8611...
Self adhesive legends for series 3611 and 8611		
12112 0100	PIK 220/110/32	Emergency exit upstairs
12112 0101	PIK 220/110/33	Emergency exit to the left
12112 0102	PIK 220/110/34	Emergency exit to the right
12112 0103	PIK 220/110/35	Emergency exit below
Cable entries		
90120 9008	2531 G	ex-protected cable gland M20 x 1,5 with locknut
90122 9001	2533 G	ex-protected cable gland M20 x 1,5 with plug and with locknut
Spare-batteries		
90222 9026	Akku NiMH 3,6V 2,2Ah Stab 8620	Spare-battery 1 h
90222 9027	Akku NiMH 6V 2,2Ah Stab 8621	Spare-battery 3 h

LED-Steep roof light fitting for Ex-Zone 2/22 Series nD822...



Applications:

Hazardous areas of Zones 2 (gas) and 22 (dust), e.g. cleanrooms, paint shops and spray booths.

Design:

Housing: Sheet steel, powder coated in light grey (RAL 7035), silicone foam gasket.

Glass cover: Impact resistant safety glass pane, frameless / hinged.

Central locking system: Operated by a 5 mm allen key, internal hinges on the opposite side.

Reflector: Hinged; white painted sheet steel; detachable, carrying LED-modules and glare limitation modules.

Connection: 3 poles up to 2.5 mm².

Cable entries: 3 entries M25 x 1.5, (2 glands - one of them is plugged)

Standard: Facing downwards or forwards.

Mechanical installation:

Mounting accessories see spare parts/ accessories.

Technical Data:

LED: Line modules appr. 5,000 K, CRI > 80, service life L₈₀ > 100,000 h at max. ambient temperature, L₉₀ > 75,000 h at 25 °C ambient temperature

ECG: 220-240 V AC/DC, 0 or 50/60 Hz, overvoltage, overload and short circuit protection

Options:

- 3,000 K; light colour (830)

- through-wiring (DV)

- stainless steel version (E.), painted

- for installation in thermally insulated ceilings in accordance with EN 60598

- for connection to central emergency supply systems (ZB)

- for connection to central emergency supply systems with integrated monitoring module

Note:

This light fitting is not suitable for application in areas with permanent high humidity in combination with only short periods of operation, such as sewage or stormwater retention tanks or water treatment plants.

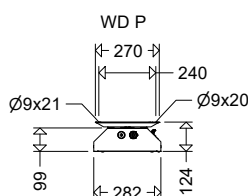
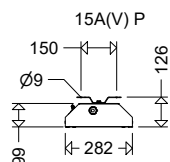
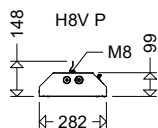
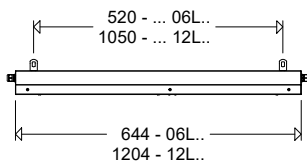
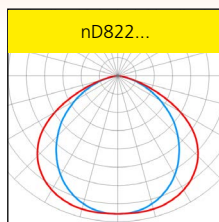

Product highlights:

- extremely flat and robust design
- perfect protection of the LED from mechanical or electrostatic damages with at the same time homogeneous illumination with glare limitation modules, no individual light points visible, comfortable perception of light, excellent glare limitation
- high colour rendering index CRI > 80, according to the workplace guide lines suitable for nearly all plant locations
- comfortable central locking system with internal hinges
- separate, frame for recessed installation or a swivel arm mounting system can easily be installed at a later stage, (frame for recessed installation not suitable for stainless steel version!)
- sustainable, control gear and reflector with LED-modules replaceable by qualified personnel on-site
- suitability for paint booths LABS-tested according to VDMA 24364-C2-L



Article no.	Type	Connected load [W]	Luminous flux [lm]	Luminous efficacy [lm/W]	Ta max [°C]	Substitute for *	Weight [kg] (without packing material)
-------------	------	--------------------	--------------------	--------------------------	-------------	------------------	--

nD822...



II 3 G Ex ec IIC T4 Gc

II 3 D Ex tc IIIC T80°C Dc

IP65



Ignition protection: ec

Marking:

II 3 G Ex ec IIC T4 Gc (Zone 2)

II 3 D Ex tc IIIC T80°C Dc (Zone 22)

Rated voltage: 220-240 V AC/DC, 0 or 50/60 Hz.

Permissible ambient temperature:

-30 °C up to +40 °C

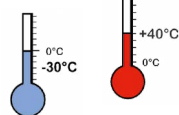

Looping the cable on one side:

All light fittings of series nD822... have got 2 cable entries on one small side of the housing for cable looping instead of the through-wiring system. (3-pole looping standard, 5-pole looping at additional cost)

Properties, limitations and details for controlling LED-light fittings:

See "Technical Supplement"

All data are correct at the time of printing. Actual technical data can be found under www.schuch.de.

* The given information is for rough orientation only. In each individual case a lighting calculation is necessary.

82200 0001	nD822 06L22	15	2.100	140	40	2 x 18W	7,6
82200 0002	nD822 06L42	28	4.110	147	40	2 x 36W	7,9
82200 0003	nD822 06L60	40	5.600	140	40	2 x 58W	7,9
82200 0050	nD822 12L42	28	4.260	152	40	2 x 36W	13,5
82200 0051	nD822 12L60	40	5.900	148	40	2 x 58W	13,5
82200 0052	nD822 12L85	54	8.350	155	40	> 2 x 58W	14,1
82200 0053	nD822 12L120	79	11.470	145	40	> 3 x 58W	14,1

Article no.	Type	Connected load [W]	Luminous flux [lm]	Luminous efficacy [lm/W]	Ta max [°C]	Substitute for *	Weight [kg] (without packing material)
-------------	------	--------------------	--------------------	--------------------------	-------------	------------------	---

nD822... DIMD

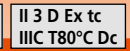
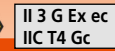

dimnable via DALI interface

Design:

Same as standard version, but with DALI-2-compatible ECG and 2 additional clamping points, marked with DA. Compatible with LIMAS Line BASIC/PRO Light Management System.

Note:

The conducting wires to the control input must be mains voltage stable and can be integrated in the connection cable.

82200 0007	nD822 06L22 DIMD	15	2.100	140	40	2 x 18W	7,6
82200 0008	nD822 06L42 DIMD	28	4.110	147	40	2 x 36W	7,9
82200 0009	nD822 06L60 DIMD	40	5.600	140	40	2 x 58W	7,9
82200 0061	nD822 12L42 DIMD	28	4.260	152	40	2 x 36W	13,5
82200 0058	nD822 12L60 DIMD	40	5.900	148	40	2 x 58W	13,5
82200 0054	nD822 12L85 DIMD	54	8.350	155	40	> 2 x 58W	14,1
82200 0055	nD822 12L120 DIMD	79	11.470	145	40	> 3 x 58W	14,1

* The given information is for rough orientation only. In each individual case a lighting calculation is necessary.

Explosion protected
Light Fittings

Installation dimensions

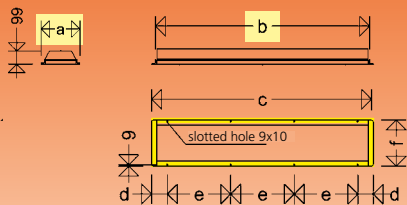

Type	a	b	c	d	e	f
EB 82. 06L	302	660	710	55	300	348
EB 82. 12L	302	1224	1270	125	340	348

Attention: When planning the opening for recess installation please allow additional clearance for the cable glands.

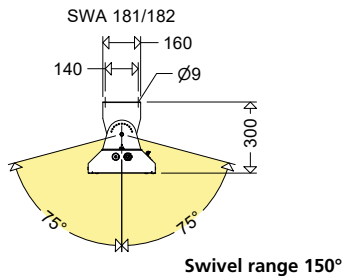
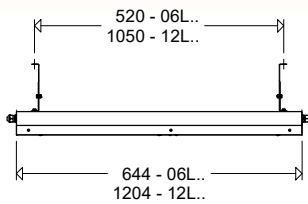

Swivel range 150°

Mounting material

Suspension brackets H8V P



Ceiling brackets 15A P



Wall/ceiling angles WD 45 P



Further accessories as well as carrier rail systems and through-wiring systems are available.

Frame for Recessed Installation

retrofit possible!

Light fittings of series nD822... can be equipped (also retrofitted, except for stainless steel versions) with an all-round angle frame for ceiling and wall installation.

Mounting by means of M5 bolts to the long sides of the housing (see drawing).

Article No.	Type	
18091 0020	EB 82. 06L	frame for narrow housing, e821 06L, nD822 06L
18091 0021	EB 82. 12L	frame for narrow housing, e821 12L, nD822 12L

Swivel Arm Mounting System

retrofit possible!

Light fittings of series nD822... can be equipped with a swivel arm mounting system at any time.

The swivel arms are fixed to the suspen-

sion points at the upper side of the housing. Swivel range: $\pm 75^\circ$ (see dimensions in diagram).

Article No.	Type	
18092 0001	SWABF 181/182 P	for all wattages consisting of: 2 swivel arms with bolts M8



Accessories / Spare Parts

Article No.	Type	
Spare glasses		
82101 9001	ABD 821 06	cover, spare safety glass clear, for 185 06 ..., e821 06 ..., nD822 06 ...
82101 9002	ABD 821 12	cover, spare safety glass clear, for 185 12 ..., e821 12 ..., nD822 12 ...
Cable entries/cable glands		
90117 9006	2537 G	ex-protected gland of size M25 x 1,5 with locknut
90119 9001	2539 G	ex-protected gland of size M25 x 1,5 with locknut and plug
90118 9006	2538 G	ex-protected plug of size M25 x 1,5 with locknut
Mounting material		
90001 0002	H8V P	2 suspension eyes, stainless steel
90000 0002	DS 15A P	2 ceiling brackets, hot galvanized steel
90032 0002	DS 15AV P	2 ceiling brackets, stainless steel
26000 0011	WDW P	2 wall/ceiling angle, painted steel
26000 0005	WDW 45 P	2 wall/ceiling angle 45°, painted steel



ExDUEVO LED High Bay Fittings for Ex-Zone 2/22 Series nD8301/nD8302...

Applications:

Hazardous locations, of Zones 2 (gas) and 22 (dust), in assembling- and production halls, warehouses, in industrial sectors, workshops, chemical factories etc.

Design:

Two versions are available: 1 (nD8301) or 2 (nD8302) LED segments.

Housing: Diecast aluminum, DB 702 (mica-iron paint).

LED-segment(s) with LED modules, optics (B- and TB-types) behind tempered safety glass (IK10).

ECG segment with integrated electronic control gear, prewired on terminals.

Light distribution: Without optic wide beam, with optic wide (B) or narrow-wide beam (TB).

Connection: 5 poles up to 4 mm²

Entries: 1 gland M25 x 1,5

Mounting material: 4 eyelets M6 (included in delivery) or see accessories/spare parts

General Purpose: Beaming downwards 0°.

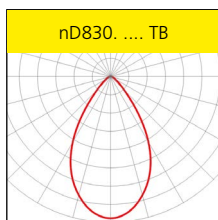
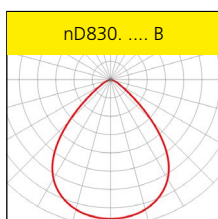
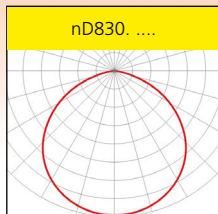
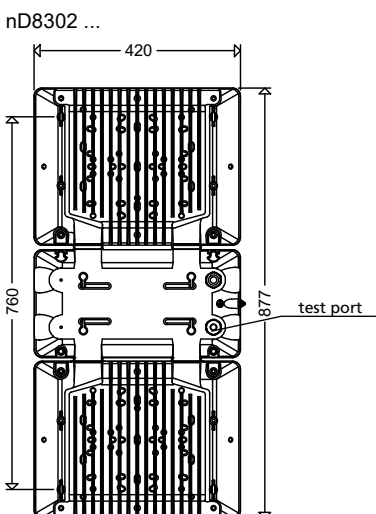
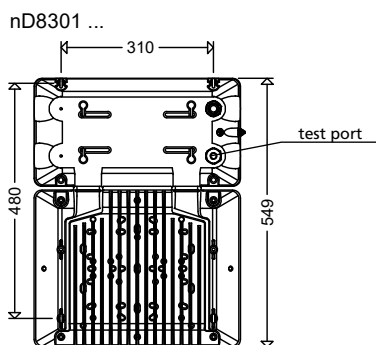
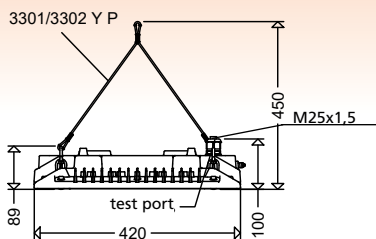

Technical Data:

LED-module: 4,000 K, CRI > 80, service life L₉₅ > 100,000 h at max. ambient temperature

ECG: 220 - 240 V, 50/60 Hz. Surge voltage resistance 4 kV, overload and short circuit protection

Ambient temperature: -30 °C up to +40 °C / +50 °C / +60 °C (see article tables)

Options:

- narrow beam (T)
- with narrow oval optic (TO), for illumination of aisles in rack areas
- cable looping at 1 small side
- for connection to central emergency supply systems (ZB)
- power reduction with control phase (LR)
- constant luminous flux function (CL)
- for wall mounting with wall brackets, cannot be retrofitted

Product highlights:

- high efficient by use of top-quality mid-power LEDs
- extremely high service life even at the maximum permissible ambient temperature
- optimized thermal management due to direct mounting of the LED modules to the housing and separate housings for ECG- and LED-modules, huge heat sink with excellent heat dissipation
- high-quality ECG with overload and short circuit protection
- DALI interface (standard) for dimmed operation, compatible with LIMAS Line BASIC/PRO (DIMD) Light Management System
- uniform illumination due to the „Multi-Layer Technology“ i.e. every individual LED illuminates the whole surface, the light curves of the individual LED are overlapping. No dark zones if any single LED would fail. The uniformity of the illumination is kept
- colour rendering index CRI > 80
- sustainable, control gear and LED-module replaceable by qualified personnel on-site
- future proof by using standardised LED-modules (Zhaga)
- GreenLine luminaire, outstanding sustainable design

Properties, limitations and details for controlling LED-light fittings:

See "Technical Supplement"

All data are correct at the time of printing. Actual technical data can be found under www.schuch.de.



Explosion protected
Light Fittings

Article no.	Type	Wide beam	Narrow-wide beam	Weight [kg] (without packing material)	T max [°C]	Connected load [W]	Luminous flux [lm]	Luminous efficacy [lm/W]
nD8301/nD8302...					II 3 G Ex nR IIC T4 Gc	II 3 D Ex tc IIIC T100°C Dc	IP65	~0.4m

Note:

This light fitting is not suitable for application in areas with permanent high humidity in combination with only short periods of operation, such as sewage or stormwater retention tanks or water treatment plants.

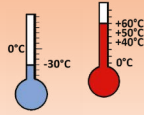

Type Examination Certificate:

IBExU 22 ATEX B013X

Other approvals:

IECEx IBE 22.0022X

Ignition protection: nR

Marking:

II 3 G Ex nR IIC T4 Gc (Zone 2)

II 3 D Ex tc IIIC T100°C Dc (Zone 22)

Rated voltage: 220 V - 240 V, 50/60 Hz

Permissible ambient temperature:

-30 °C up to +40 °C / +50 °C / +60 °C

... for ambient temperatures up to +40 °C

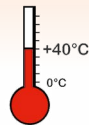

1 LED segment

83010 0001	nD8301 L110	•	8,9	40	66	12.000	182
83010 0004	nD8301 L110B	•	9,2				
83010 0007	nD8301 L110TB	•	9,2				
83010 0002	nD8301 L160	•	8,9	40	96	17.000	177
83010 0005	nD8301 L160B	•	9,2				
83010 0008	nD8301 L160TB	•	9,2				
83010 0003	nD8301 L210	•	8,9	40	135	23.000	170
83010 0006	nD8301 L210B	•	9,2				
83010 0009	nD8301 L210TB	•	9,2				

2 LED segments

83020 0002	nD8302 L320	•	14,5	40	192	34.000	177
83020 0005	nD8302 L320B	•	14,6				
83020 0008	nD8302 L320TB	•	14,6				
83020 0003	nD8302 L420	•	14,5	40	270	46.000	170
83020 0006	nD8302 L420B	•	14,6				
83020 0009	nD8302 L420TB	•	14,6				

... for ambient temperatures up to +50 °C

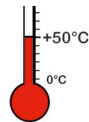

1 LED segment

83010 0101	nD8301 L110 H50	•	8,9	50	66	12.000	182
83010 0104	nD8301 L110B H50	•	9,2				
83010 0107	nD8301 L110TB H50	•	9,2				
83010 0102	nD8301 L160 H50	•	8,9	50	96	17.000	177
83010 0105	nD8301 L160B H50	•	9,2				
83010 0108	nD8301 L160TB H50	•	9,2				

2 LED segments

83020 0101	nD8302 L220 H50	•	14,5	50	132	24.000	182
83020 0104	nD8302 L220B H50	•	14,6				
83020 0107	nD8302 L220TB H50	•	14,6				
83020 0102	nD8302 L320 H50	•	14,5	50	192	34.000	177
83020 0105	nD8302 L320B H50	•	14,6				
83020 0108	nD8302 L320TB H50	•	14,6				

... for ambient temperatures up to +60 °C

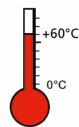

1 LED segment

83010 0201	nD8301 L110 H60	•	8,9	60	66	12.000	182
83010 0204	nD8301 L110B H60	•	9,2				
83010 0207	nD8301 L110TB H60	•	9,2				
83010 0202	nD8301 L160 H60	•	8,9	60	96	17.000	177

2 LED segments

83020 0201	nD8302 L220 H60	•	14,5	60	132	24.000	182
83020 0204	nD8302 L220B H60	•	14,6				
83020 0207	nD8302 L220TB H60	•	14,6				
83020 0202	nD8302 L320 H60	•	14,5	60	192	34.000	177

Accessories / Spare Parts

Article no.	Type	
90117 9006	2537 G	ex-protected plastic cable gland M25 x 1,5 with locknut
90119 9001	2539 G	ex-protected plastic cable gland M25 x 1,5 with locknut and plug
33001 9004	3301/3302 Y P	1 pair of Y-ropes, (2-point-mounting)
33001 9002	DBF 3301/3302	1 pair of angle brackets for direct ceiling mounting

NEW

ExAREALO 2 LED High Bay Fittings for Ex-Zone 2/22 Series nD8955...



Applications:

Hazardous locations, of Zones 2 (gas) and 22 (dust), in assembling- and production halls, warehouses, in industrial sectors, workshops, chemical factories etc.

Design:

Housing: Die-cast aluminium, 1-part, powder-coated DB 702 with LED module, optics, ECG and cable entry.

Glass: Flat safety glass pane, resistant to temperature changes, impact resistant IK09, silicone gasket.

Light distribution: Without optics wide beam, with optics wide beam (B), narrow wide beam (TB) or narrow beam (T), narrow oval beam (TO) for illumination of aisles in rack areas respectively asymmetrical beam (A).

Entries: 1 gland M25 x 1.5.

Connection: Connection compartment accessible from outside, terminal up to max. 2.5 mm².

Mounting: 4 eyelets included in delivery.

General Purpose: Beaming downwards 0°.

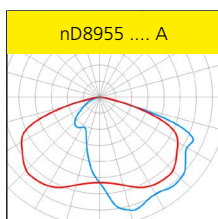
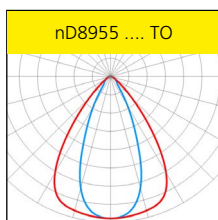
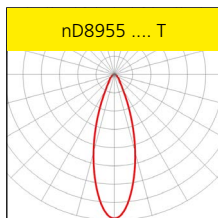
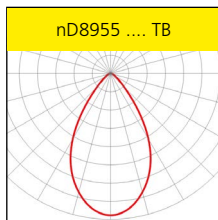
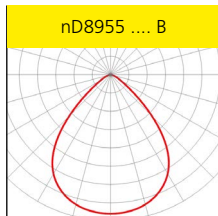
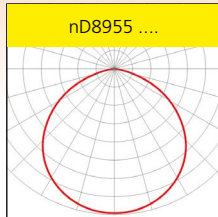
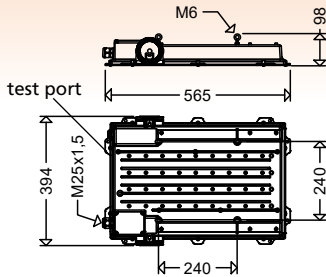

Technical Data:

LED module: 4,000 K, CRI > 80, service life L₉₅ > 100,000 h at max. ambient temperature, Zhaga compliant

ECG: 220 - 240 V, 50/60 Hz. Surge voltage resistance 4 kV, overload and short circuit protection

Ambient temperature: -30 °C up to +40 °C

Options:

- 5,000 K; light colour (850)
- for higher ambient temperatures (H65), up to +65 °C
- seawater-resistant version
- for connection to central emergency supply systems (ZB)



- dimming function via DALI-2 interface, compatible with LIMAS Line BASIC/ PRO wired Light Management System (DIMD)
- constant luminous flux function (CL)

Product highlights:

- long-lasting, corrosion-resistant die-cast aluminium housing
- optimized thermal management due to direct mounting of the LED modules to the housing, large cooling surface, excellent heat dissipation
- uniform illumination due to the „Multi-Layer Technology“
- high system service life of up to 100,000 h, saves premature replacement and conserves valuable resources
- high energy cost savings thanks to low connected load and high efficiency
- sustainable, control gear and LED-module replaceable by qualified personnel on-site
- future proof by using standardised LED-modules (Zhaga) and long-term availability of spare parts
- GreenLine luminaire, outstanding sustainable design

Explosion protected
Light Fittings



Properties, limitations and details for controlling LED-light fittings:

See "Technical Supplement"

All data are correct at the time of printing. Actual technical data can be found under www.schuch.de.

Article no.	Type	Dimmable	Wide beam	Narrow wide beam	Narrow beam	Asymmetrical beam	Tmax [°C]	Weight [kg] (without packing material)	Connected load [W]	Luminous flux [lm]	Light output [lm/W]	Substitute for *
-------------	------	----------	-----------	------------------	-------------	-------------------	-----------	--	--------------------	--------------------	---------------------	------------------

Note:
This light fitting is not suitable for application in areas with permanent high humidity in combination with only short periods of operation, such as sewage or stormwater retention bassins or water treatment plants.

nD8955...



II 3 G Ex nR IIC T4 Gc

II 3 D Ex tc IIIC T100°C Dc

IP65

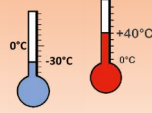

Ignition protection: nR
Marking:
II 3 G Ex nR IIC T4 Gc (Zone 2)
II 3 D Ex tc IIIC T100°C Dc (Zone 2)

Rated voltage: 220 V - 240 V, 50/60 Hz
Permissible ambient temperature:
-30 °C up to +40 °C

89550 0101	nD8955 L250		•									
89550 0102	nD8955 L250 B		•									
89550 0103	nD8955 L250 TB			•								
89550 0104	nD8955 L250 T				•							
89550 0105	nD8955 L250 TO					•						
89550 0106	nD8955 L250 A						•					
89550 0107	nD8955 L250 DIMD	•	•									
89550 0108	nD8955 L250 B DIMD	•	•									
89550 0109	nD8955 L250 TB DIMD	•		•								
89550 0110	nD8955 L250 T DIMD	•			•							
89550 0111	nD8955 L250 TO DIMD	•				•						
89550 0112	nD8955 L250 A DIMD	•					•					
89550 0201	nD8955 L360		•									
89550 0202	nD8955 L360 B		•									
89550 0203	nD8955 L360 TB			•								
89550 0204	nD8955 L360 T				•							
89550 0205	nD8955 L360 TO					•						
89550 0206	nD8955 L250 A						•					
89550 0207	nD8955 L360 DIMD	•	•									
89550 0208	nD8955 L360 B DIMD	•	•									
89550 0209	nD8955 L360 TB DIMD	•		•								
89550 0210	nD8955 L360 T DIMD	•			•							
89550 0211	nD8955 L360 TO DIMD	•				•						
89550 0212	nD8955 L360 A DIMD	•					•					
89550 0301	nD8955 L470		•									
89550 0307	nD8955 L470 DIMD	•	•									

* This date is a rough guideline. In individual cases a lighting calculation is required.

Accessories / Spare Parts

Article no.	Type	
79559 0001	WDBF 7955 ST	Wall and ceiling mounting, galvanised steel, painted in DB 702
79559 0003	WDBF 7955 E4	Wall and ceiling mounting, stainless steel V4A, for SBL version, painted in DB 702
79559 0004	7955 Y P ST	1 pair of Y-ropes



ExFOCO L LED-Floodlight for Ex-Zone 2/22 Series nD8700...

Applications:

Hazardous locations of Zones 2 (gas atmosphere) and 22 (dust atmosphere), indoor and outdoor areas, stockyards, e.g. construction sites, transport routes, pipe bridge, pedestrian areas etc.

Design:

Housing: Die-cast aluminium, 2-parts, powder coated DB 702 (mica-iron paint, grey).

Upper part: With LED- and optics-modules,

Lower part: With electronic ballast, glass cover, cable entry with cable relief, retractable.

Glass: Flat safety glass pane, resistant to

temperature changes, impact resistant IK10, silicone gasket.

Light distribution: With optics narrow-wide (TB), narrow (T) or asymmetrical beam (A), without optics wide beam.

Connection terminal: 3-pole terminal max. clamping range 2,5 mm².

Cable entry: 1 gland M20 x 1.5.

Mounting: Mounting bracket, swivel range 180°, for wall- or ceiling mounting. Separate accessories are required for pole mounting (see Accessories/Spare Parts).

Standard Mounting: Facing downwards or horizontal.

Technical Data:

LED module: 4.000 K or 3.000 K, R₃ > 70, service life L₉₅ > 100.000 h at max. ambient temperature, Zhaga compliant

ECG: 220-240 V, 50-60 Hz, Surge voltage resistance 10 kV, overload and short circuit protection.

Ambient temperature: -30 °C up to +40 °C

Options:

- for higher ambient temperatures (H55), up to +55 °C
- seawater resistant version
- for connection to central emergency supply systems (ZB)
- dimming function via DALI-2 interface, compatible with LIMAS Line BASIC/



PRO wired Light Management System (DIMD)

- power reduction with control phase (LR)
- constant luminous flux function (CL)

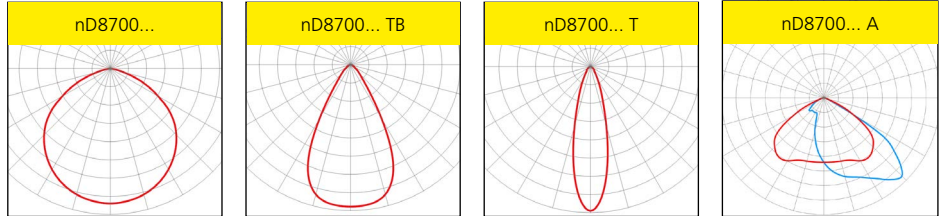
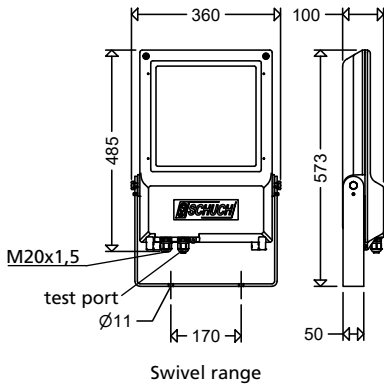

Standard Mounting

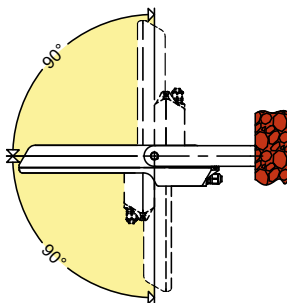

Product highlights:

- ECG with surge voltage resistance, reliable due to **overload and short circuit protection**
- **optimized thermal management** due to direct adaption of the LED-modules to the die-cast aluminium housing, large cooling surface, excellent heat dissipation
- **optimal light distribution** due to highly efficient optics
- **homogeneous illumination** due to the **Multi-Layer-Technology** i.e. every individual LED illuminates the whole surface, the light curves of the individual LEDs are overlapping.
- **comfortable maintenance** due to **removable lower part of the housing**, large opening allows easy access to the terminal box and the electrical components, ECG replaceable on-site
- **eco-friendly**, no light emission into the upper half-space, **ULOR=0 (Plane surface floodlight)**
- versions dimmable to 10% and with color temperature up to 3,000 K comply with **Dark Sky requirements**
- **sustainable**, control gear and LED-module replaceable by qualified personnel on-site
- **future proof** by using **standardised LED-modules (Zhaga)**
- **GreenLine luminaire**, outstanding sustainable design

! Properties, limitations and details for controlling LED-light fittings:

■ See "Technical Supplement"

All data are correct at the time of printing. Actual technical data can be found under www.schuch.de.

Article no.	Type	Wide beam	Narrow wide beam	Narrow beam	Asymmetrical beam	Tmax [°C]	Weight [kg] (without packing material)	Connected load [W]	Luminous flux [lm]	Light output [lm/W]
-------------	------	-----------	------------------	-------------	-------------------	-----------	---	--------------------	--------------------	---------------------

Note:

This light fitting is not suitable for application in areas with permanent high humidity in combination with only short periods of operation, such as sewage or stormwater retention tanks or water treatment plants.

nD8700/ ...



II 3 G Ex nR IIC
T4 Gc

II 3 D Ex tc IIIC
T100°C Dc

IP66

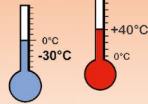

Type Examination Certificate:

IBExU 22 ATEX B012X

Other approvals:

IECEX IBE 22.0021X

Ignition protection: nR

Marking:

II 3 G Ex nR IIC T4 Gc (Zone 2)

II 3 D Ex tc IIIC T100°C Dc (Zone 22)

Rated voltage: 220 V up to 240 V AC,
50/60 Hz

Permissible ambient temperature:

-30 °C up to +40 °C

colour temperature 4.000 K (light colour 740)

87000 0007	nD8700 4803	•				40	9,7	106	16.790	158
87000 0008	nD8700 4803TB		•							
87000 0014	nD8700 4803T			•						
87000 0009	nD8700 4803A				•					
87000 0001	nD8700 6403	•				40	9,7	140	21.940	157
87000 0002	nD8700 6403TB		•							
87000 0013	nD8700 6403T			•						
87000 0003	nD8700 6403A				•					

colour temperature 3.000 K (light colour 730)

87000 0032	nD8700 4803 730	•				40	9,7	106	15.950	150
87000 0033	nD8700 4803TB 730		•							
87000 0034	nD8700 4803T 730			•						
87000 0035	nD8700 4803A 730				•					
87000 0036	nD8700 6403 730	•				40	9,7	140	20.840	149
87000 0037	nD8700 6403TB 730		•							
87000 0038	nD8700 6403T 730			•						
87000 0039	nD8700 6403A 730				•					

Pipe clamp fastening: ROB 60/76 G2

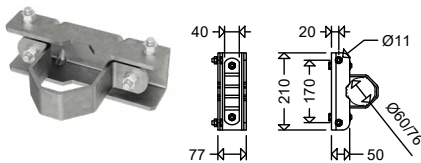

Single mounting: MAU 1 76/170 M10

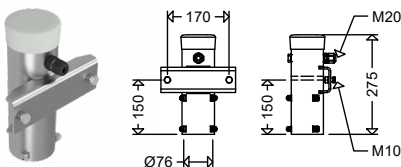

Double mounting: MAU 2 76/170 M10

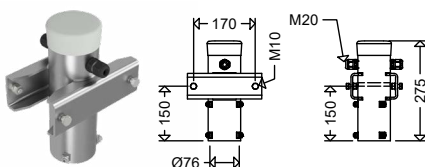

Accessories / Spare Parts

Article no.	Type	
Cable glands		
90120 9000	2531	ex-protected plastic cable gland M20 x 1,5
90122 9000	2533	ex-protected plastic cable gland M20 x 1,5 with plug
Mounting material		
90270 0006	ROB 60/76 G2	Pipe clamp fastening for direct pole mounting; galvanised steel, not for stainless steel brackets
75739 9001	MAU 1 76/170 M10	Pole top for single mounting, ø 76 mm, galvanized steel
75739 9002	MAU 2 76/170 M10	Pole top for double mounting, ø 76 mm, galvanized steel



ExFOCO XL LED-Floodlight for Ex-Zone 2/22 Series nD8800...

Applications:

Hazardous locations of Zones 2 (gas) and 22 (dust), indoor and outdoor areas, stockyards, construction sites, transport routes, pipe bridge, pedestrian areas etc.

Design:

Housing: Die-cast aluminium, 2-parts, powder coated DB 702 (mica-iron paint, grey).

Upper part: With LED- and optics-modules

Lower part: With electronic ballast, glass cover, cable entry with cable relief, retractable.

Glass: Flat safety glass pane, resistant to temperature changes, impact resistant IK09, silicone gasket.

Connection terminal: 3-pole terminal, max. clamping range 2.5 mm².

Cable entry: 1 gland M25 x 1.5.

Mounting: Mounting bracket, swivel range 180°, for wall- or ceiling mounting. Separate accessories are required for pole mounting (see Accessories/Spare Parts).

Standard Mounting: Facing downwards or horizontal.

Technical Data:

LED module: 4,000 K or 3,000 K, $R_a > 70$, service life $L_{95} > 100,000$ h at max. ambient temperature, Zhaga compliant

ECG: 220-240 V, 50-60 Hz, Surge voltage resistance 10 kV, overload and short circuit protection.

Ambient temperature: -30 °C up to +40 °C

Options:

- for higher ambient temperatures (H50), up to +50 °C
- seawater resistant version
- for connection to central emergency supply systems (ZB)
- dimming function via DALI-2 interface, compatible with LIMAS Line BASIC/

PRO wired Light Management System (DIMD)

- power reduction with control phase (LR)
- constant luminous flux function (CL)

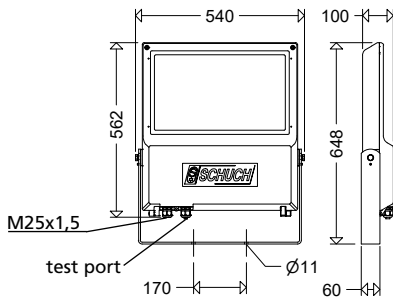

Swivel range

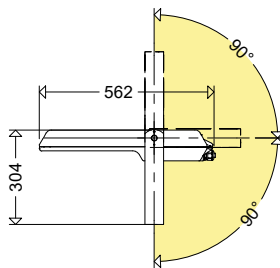

Standard Mounting

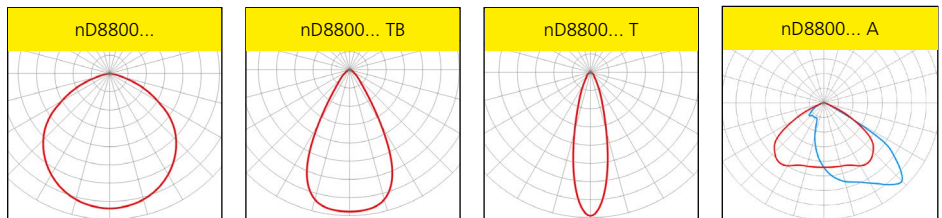
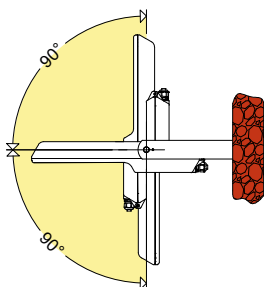

Product highlights:

- ECG with surge voltage resistance, reliable due to overload and short circuit protection
- optimized thermal management due to direct adaption of the LED-modules to the die-cast aluminium housing, large cooling surface, excellent heat dissipation
- optimal light distribution due to highly efficient optics
- homogeneous illumination due to the Multi-Layer-Technology i.e. every individual LED illuminates the whole surface, the light curves of the individual LEDs are overlapping.
- comfortable maintenance due to removable lower part of the housing, large opening allows easy access to the terminal box and the electrical components, ECG replaceable on-site
- eco-friendly, no light emission into the upper half-space, $ULOR=0$ (Plane surface floodlight)
- versions dimmable to 10% and with color temperature up to 3,000 K comply with Dark Sky requirements
- sustainable, control gear and LED-module replaceable by qualified personnel on-site
- future proof by using standardised LED-modules (Zhaga)
- GreenLine luminaire, outstanding sustainable design

Properties, limitations and details for controlling LED-light fittings:

See "Technical Supplement"

All data are correct at the time of printing. Actual technical data can be found under www.schuch.de.

Article no.	Type	Wide beam	Narrow wide beam	Narrow beam	Asymmetrical beam	Tmax [°C]	Weight [kg] (without packing material)	Connected load [W]	Luminous flux [lm]	Light output [lm/W]
-------------	------	-----------	------------------	-------------	-------------------	-----------	---	--------------------	--------------------	---------------------

Note:

This light fitting is not suitable for application in areas with permanent high humidity in combination with only short periods of operation, such as sewage or stormwater retention tanks or water treatment plants.

nD8800/ ...



II 3 G Ex nR IIC
T4 Gc

II 3 D Ex tc IIIC
T100°C Dc

IP66

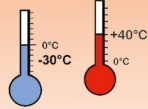
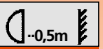

Type Examination Certificate:

IBExU 22 ATEX B012X

Other approvals:

IECEx IBE 22.0021X

Ignition protection: nR

Marking:

II 3 G Ex nR IIC T4 Gc

(Zone 2)

II 3 D Ex tc IIIC T100°C Dc

(Zone 22)

Rated voltage: 220 V up to 240 V AC,
50/60 Hz

Permissible ambient temperature:

-30 °C up to +40 °C

colour temperature 4.000K (light colour 740)

88000 0001	nD8800 6403	•							
88000 0002	nD8800 6403TB		•						
88000 0013	nD8800 6403T			•					
88000 0003	nD8800 6403A				•				
88000 0008	nD8800 12802TB		•						
88000 0014	nD8800 12802T			•					
88000 0009	nD8800 12802A				•				
88000 0007	nD8800 12803	•							

colour temperature 3.000K (light colour 730)

88000 0025	nD8800 6403 730	•							
88000 0026	nD8800 6403TB 730		•						
88000 0027	nD8800 6403T 730			•					
88000 0028	nD8800 6403A 730				•				
88000 0030	nD8800 12802TB 730		•						
88000 0031	nD8800 12802T 730			•					
88000 0032	nD8800 12802A 730				•				
88000 0029	nD8800 12803 730	•							

Pipe clamp fastening: ROB 60/76 G2

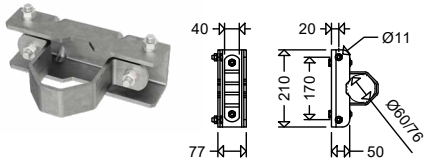

Single mounting: MAU 1 76/170 M10

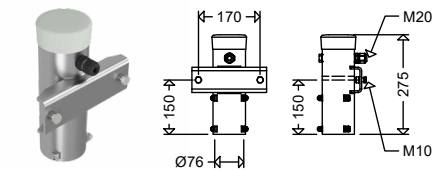

Double mounting: MAU 2 76/170 M10

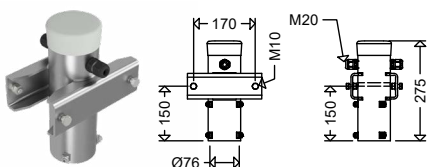

Accessories / Spare Parts

Article no.	Type	
Cable glands		
90117 9000	2537	ex-protected plastic cable gland M25 x 1,5
90119 9000	2539	ex-protected plastic cable gland M25 x 1,5 with plug
Mounting material		
90270 0006	ROB 60/76 G2	Pipe clamp fastening for direct pole mounting; galvanized steel, not for stainless steel brackets
75739 9001	MAU 1 76/170 M10	Pole top for single mounting, Ø 76 mm, galvanized steel
75739 9002	MAU 2 76/170 M10	Pole top for double mounting, Ø 76 mm, galvanized steel

NEW

ExAREALO 2 LED-Floodlight for Ex-Zone 2/22 Series nD8950...

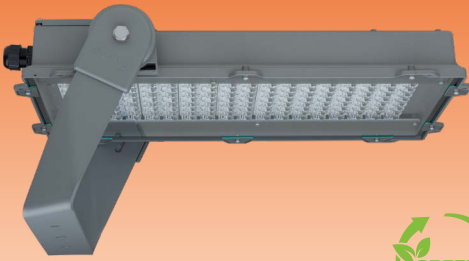

Applications:

Hazardous locations of Zones 2 (gas atmosphere) and 22 (dust atmosphere), indoor and outdoor areas, stockyards, e.g. construction sites, transport routes, pipe bridge, pedestrian areas etc.

Design:

Housing: Die-cast aluminium, 1-part, powder-coated DB 702 (mica-iron paint, grey) with LED module, optics, ECG and cable entry.
Glass: Flat safety glass pane, resistant to temperature changes, impact resistant IK09, silicone gasket.

Light distribution: With optics narrow-wide (TB), narrow (T) or asymmetrical beam (A), without optics wide beam.

Connection: Connection compartment accessible from outside, terminal up to max. 2.5 mm².

Cable entry: 1 x M25 cable gland.

Mounting: Mounting bracket can be swivelled through 180° in 5° steps, with holes for wall or ceiling mounting. Separate accessories are required for pole mounting (see accessories/spare parts).

Standard Mounting: Facing downwards or forwards.

Technical Data:

LED module: 4,000 K or 3,000 K, R_a > 70, service life L₉₅ > 100,000 h at max. ambient temperature, Zhaga compliant

ECG: 220-240 V, 50-60 Hz, Surge voltage resistance 10kV, overload and short circuit protection.

Ambient temperature: -30 °C up to +40 °C

Options:

- 2,200 K; light colour (722)
- for higher ambient temperatures (H65), up to +65 °C
- asymmetrical wide beam (AB)
- asymmetrical extremely wide beam (RWX)
- seawater-resistant version
- bird deterrence



- dimming function via DALI-2 interface, compatible with LIMAS Line BASIC/ PRO wired Light Management System (DIMD)
- constant luminous flux function (CL)

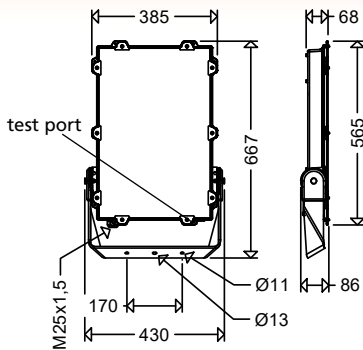

Swivel range

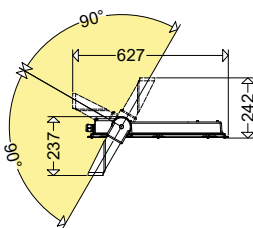

Standard Mounting

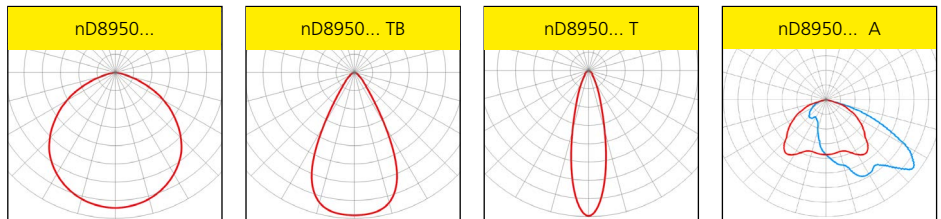
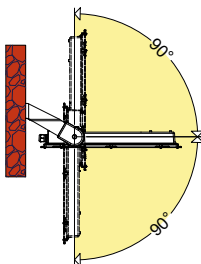

Product highlights:

- durable, corrosion-resistant die-cast aluminium housing
- low total weight, low mast load
- excellent thermal management, long service life
- quick electrical connection due to outlying electrical connection box
- homogeneous illumination due to the Multi-Layer-Technology
- high system service life of up to 100,000 h, saves premature replacement and conserves valuable resources
- high energy cost savings thanks to low connected load and high efficiency
- eco-friendly, no light emission into the upper half-space, ULOR=0
- versions dimmable to 10% and with colour temperature up to 3,000 K comply with Dark Sky requirements
- sustainable, control gear and LED-module replaceable by qualified personnel on-site
- future proof by using standardised LED-modules (Zhaga) and long-term availability of spare parts
- GreenLine luminaire, outstanding sustainable design

Properties, limitations and details for controlling LED-light fittings:

See "Technical Supplement"

All data are correct at the time of printing. Actual technical data can be found under www.schuch.de.



Explosion protected
Light Fittings

Article no.	Type	Wide beam	Narrow wide beam	Narrow beam	Asymmetrical beam	Tmax [°C]	Weight [kg] (without packing material)	Connected load [W]	Luminous flux [lm]	Light output [lm/W]	Substitute for *
-------------	------	-----------	------------------	-------------	-------------------	-----------	--	--------------------	--------------------	---------------------	------------------

Note:

This light fitting is not suitable for application in areas with permanent high humidity in combination with only short periods of operation, such as sewage or stormwater retention bassins or water treatment plants.

nD8950...



II 3 G Ex nR IIC T4 Gc

II 3 D Ex tc IIIC T100°C Dc

IP65

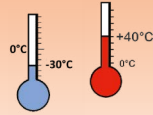
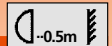

Ignition protection: nR

Marking:

II 3 G Ex nR IIC T4 Gc (Zone 2)

II 3 D Ex tc IIIC T100°C Dc (Zone 22)

Rated voltage: 220 V - 240 V, 50/60 Hz

Permissible ambient temperature:

-30 °C up to +40 °C

colour temperature 4.000K (light colour 740)

Article no.	Type	Wide beam	Narrow wide beam	Narrow beam	Asymmetrical beam	Length [mm]	Weight [kg]	Power [W]	Luminous flux [lm]	Light output [lm/W]	Substitute for *
89500 0101	nD8950 14401	•				40	10,7	144	26.500	184	HIE 400 (HS-VG), HIT400
89500 0102	nD8950 14401 TB		•								
89500 0103	nD8950 14401 T			•							
89500 0104	nD8950 14401 A			•							
89500 0201	nD8950 14402	•				40	11,0	209	36.800	176	HIT 400
89500 0202	nD8950 14402 TB		•								
89500 0203	nD8950 14402 T			•							
89500 0204	nD8950 14402 A			•							
89500 0301	nD8950 14403	•				40	11,0	298	49.300	165	2 x HIT 250, HME 400
89500 0302	nD8950 14403 TB		•								
89500 0303	nD8950 14403 T			•							
89500 0304	nD8950 14403 A			•							

colour temperature 3.000K (light colour 730)

Article no.	Type	Wide beam	Narrow wide beam	Narrow beam	Asymmetrical beam	Length [mm]	Weight [kg]	Power [W]	Luminous flux [lm]	Light output [lm/W]	Substitute for *
89500 0105	nD8950 14401 730	•				40	10,7	144	25.200	175	HIE 400 (HS-VG), HIT400
89500 0106	nD8950 14401 730 TB		•								
89500 0107	nD8950 14401 730 T			•							
89500 0108	nD8950 14401 730 A			•							
89500 0205	nD8950 14402 730	•				40	11,0	209	35.000	167	HIT 400
89500 0206	nD8950 14402 730 TB		•								
89500 0207	nD8950 14402 730 T			•							
89500 0208	nD8950 14402 730 A			•							
89500 0305	nD8950 14403 730	•				40	11,0	298	46.800	157	2 x HIT 250, HME 400
89500 0306	nD8950 14403 730 TB		•								
89500 0307	nD8950 14403 730 T			•							
89500 0308	nD8950 14403 730 A			•							

* This date is a rough guideline. In individual cases a lighting calculation is required.

Pipe clamp fastening: ROB 60/76 G2

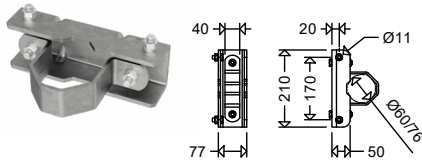

Single mounting: MAU 1 76/170 M10

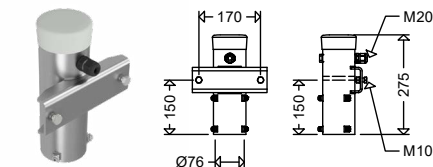

Double mounting: MAU 2 76/170 M10

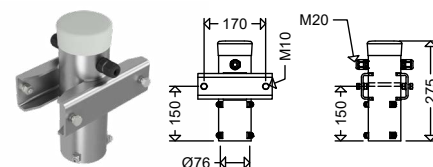

Accessories / Spare Parts

Article no.	Type	
Cable glands		
90117 9000	2537	ex-protected plastic cable gland M25 x 1,5
90119 9000	2539	ex-protected plastic cable gland M25 x 1,5 with plug
Mounting material		
90270 0006	ROB 60/76 G2	Pipe clamp fastening for direct pole mounting; galvanised steel, not for stainless steel brackets
75739 9001	MAU 1 76/170 M10	Pole top for single mounting, Ø 76 mm, galvanized steel
75739 9002	MAU 2 76/170 M10	Pole top for double mounting, Ø 76 mm, galvanized steel

Aluminium Carrier Rails for Continuous Row Installation Series TRS 2000... and AL...

Application:

For rows of light fittings suspended from the ceiling, allowing an easy installation and assembly.

Design:

Aluminium profiled carrier rails (AL / TRS 2000)

Lengths: 2, 3 or 5 m. Additional covering strip (TRS A) for series TRS.

Mounting accessories:

For each length of a light fitting only one suspension point is required.

Connection brackets (TRS V) - to be ordered separately - allow joining the individual rails up to any length wanted.

The carrier rails can either be mounted

directly to the ceiling by means of the ceiling brackets (183 A / TRS ED) or they can be suspended from the ceiling by means of the hook (183 H / TRS ER) in combination with the chain (KP 40) (max. distance of mounting rail elements 2.5 m). Perlon pendulums are not suitable for this purpose.

2 or 3 devices (183 L / TRS EL) serve for mounting a light fitting to the rail. The suspension devices 183 A / TRS ED and 183 H / TRS ER as well as the devices 183 L / TRS EL are movable in the longitudinal direction of the rails.

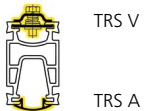
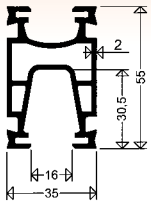

TRS V

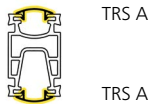

TRS A



TRS ER

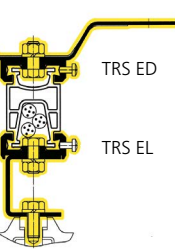

TRS ED

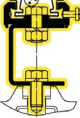

TRS EL

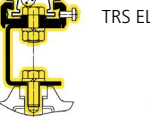

TRS EL

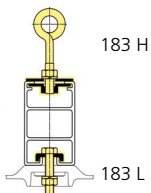
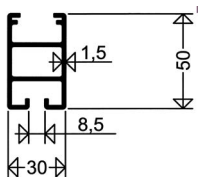

183 H

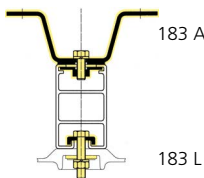

183 A



183 L

183 L

TRS 2000...

aluminium carrier rails with high loading capacity

for series e840..., e864..., e865..., e821..., nD822...

Product highlights:

- Universal quick-action mounting system for explosion- and weather-proof light fittings
- easy to install (mount the suspension devices to the light fitting, then push the light fitting into the carrier rail profile)
- higher load capacity due to new profile design
- inserting the mains cable into the cable channel is possible
- a cover strip serves as a protection against dirt deposit

Article No.	Type	Product	Weight ca. [kg]
90260 0001	TRS 2000 2M	Alu-rail 2 m long	3,03
90260 0002	TRS 2000 3M	Alu-rail 3 m long	4,55
90260 0003	TRS 2000 5M	Alu-rail 5 m long	7,58
90265 0005	TRS 2000 A 1M	covering strip, 1 m long	0,04
90265 0006	TRS 2000 A 2M	covering strip, 2 m long	0,07

Mounting Devices

Article No.	Type	Product
90265 0004	TRS 2000 V	stainless steel device (profile) for rail connection
90265 0008	TRS 2000 ED	stainless steel ceiling bracket for mounting the rail
90022 0001	KP 40	chain 1 m long with 2 eyelets for fastening and length compensation
90265 0007	TRS 2000 ER	stainless steel ring nut for chain
90265 0009	TRS 2000 EL P	stainless steel mounting bracket

AL...

aluminium carrier rails for series nD866.../nD867

Article No.	Type	Product	Weight ca. [kg]
90005 0001	AL 2M	Alu-rail 2 m long	1,6

Mounting Devices

Article -No.	Type	Product
90265 0004	TRS 2000 V	stainless steel device for rail connection
90185 0001	183 A	stainless steel ceiling bracket for ceiling mounting of the carrier rail
90022 0001	KP 40	chain 1 m long with 2 eyelets for fastening and length compensation
90049 0001	183 H	stainless steel hook for chain pendulum
90050 0001	183 L	stainless steel mounting bracket

Through-wiring Systems for Explosion-Protected Light Fittings

For all light fittings installed in a continuous row. Through-wiring system with 2 multipole terminals which are fixed inside the light fitting.
(Since retrofitting the through-wiring system on site is subject to special regulations in regard to hazardous areas, we do recommend a factory-made through-wiring system.)

Through-wiring systems:
2.5 mm² up to 16 A
4.0 mm² up to 20 A
(depending on the permissible ambient temperature of the light fitting).

Note:

With the "variable cable entries" most of our explosion-protected fluorescent fittings are well suited for **looping the cable at one end** of the fitting. This allows a perfect adaptation to the local conditions and moreover in many cases this spares the classic through-wiring system.

Please contact us for details in regard to explosion-protected fittings with looping system.

Factory-made through-wiring system

Our explosion-protected light fittings of Zone 1/21 and Zone 2/22 with factory-made through-wiring systems will be delivered with the standard through-wiring system 5x2,5mm² PVC of 6x2,5mm² PVC (emergency fittings Zone1/21). Fittings with such standard through-wiring do have separate part numbers.

Example: Type e840..

Article No.	Type	Through-wiring system)
84005 0001	e840 12L42	without through-wiring system)
84005 1001	e840 12L42 DV	with classical through-wiring system 5 x 2.5 mm ² PVC

Through wiring systems for other cable cross sections (e.g. 4 mm²) or number of poles (e.g. 3 x 2,5 mm²) are available on request.

Through-wiring system for retrofit

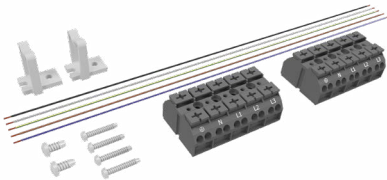

Article No.	Type	
for ex-proof LED-light fittings zone 1/21		
11501 0020	DV/NS ZO1/21 LED e865 06L	5 x 2,5 mm ² PVC, für e865 06 ...
11501 0019	DV/NS ZO1/21 LED e865 12L, e840 12L	5 x 2,5 mm ² PVC, for e840... and e865 12 ...
for ex-proof LED-light fittings zone 2/22		
11891 0015	DV/NS ZO2/22 LED nD866 06L	5 x 2,5 mm ² PVC, für nD866 06 ...
11891 0014	DV/NS ZO2/22 LED nD866 12L	5 x 2,5 mm ² PVC, nD866 12 ...

Through-wiring retrofit sets for other series or other cable cross sections are also available.



Explosion-Protected Wall Sockets System SolConeX Series 4216...

Applications:

Hazardous areas of zones 1, 21 and 2, 22

Cable entry:

1 cable gland M25 x 1,5 and
1 plug M25 x 1,5 (at bottom)

Design:

Housing: Made from impact resistant plastic material with lock-up switch.
System SolConeX

Type	Ident.-No.	Dimens./mm height/length	Width resp. Ø
4216/306	8570/11-306	232	105
4216/506	8570/11-506	248	115

DB are standardised by Deutsche Bahn AG

4216/...

or voltages up to 415 V



II 2 G Ex db eb
IIC T6 Gb

II 2 D Ex tb IIIC
T80°C Db

IP66



EU-Type Examination Certificate:

PTB 03 ATEX 1227

Ignition protection:

e (increased safety)

Marking:

II 2 G Ex db eb IIC T6 Gb

II 2 D Ex tb IIIC T80°C Db

Temperature class: T6

Permissible ambient temperature:

-30 °C bis +55 °C

Article No.	Type	Rated-current	Voltage	Poles	Conn. terminals	Weight ca. [kg]
41060 0006	4216/306	16 A	200-250 V	2P + PE	up to 2 x 6,0 mm ²	1,12
41060 0008	4216/506	16 A	200-415 V	3P + N + PE	up to 2 x 6,0 mm ²	1,45



Explosion-Protected Plugs System SolConeX Series 4210...

Applications:

Hazardous areas of zones 1, 21 and 2, 22.

Cable entry:

8 to 20 mm cable

Design:

Housing: Made from impact resistant plastic material. System SolConeX

Type	Ident.-No.	Dimens./mm height/length	Width resp. Ø
4210/306	8570/12-306	176	76
4210/506	8570/12-506	176	92

Covering cap for plug available upon request.

DB are standardised by Deutsche Bahn AG

4210/...

for voltages up to 415 V



II 2 G Ex db eb
IIC T6 Gb

II 2 D Ex tb IIIC
T80°C Db

IP66



EU-Type Examination Certificate:

PTB 03 ATEX 1227

Ignition protection:

e (increased safety)

Marking:

II 2 G Ex db eb IIC T6 Gb

II 2 D Ex tb IIIC T80°C Db

Temperature class: T6

Permissible ambient temperature:

-30 °C bis +55 °C

Article No.	Type	Rated current	Voltage	Pole	Conn. terminals	Weight ca. [kg]
41050 0006	4210/306	16 A	200-250 V	2P + PE	up to 2 x 6,0 mm ²	0,38
41050 0008	4210/506	16 A	200-415 V	3P + N + PE	up to 2 x 6,0 mm ²	0,50

Explosion-Protected Installation Switches Series 8040...



Applications:

For switching lighting installations in hazardous areas of Zones 1, 21 and 2, 22. Pay attention to the permissible switching capacities.

Design:

Housing and cover: Made from impact resistant glass fibre reinforced polyester resin. Rotary handle fluorescent. 90° switching.

Connection terminals:

stranded wire: 1,5 ... 2,5 mm².
solid wire: 1,5 ... 4,0 mm²

Cable entry:

1 cable gland M25 x 1,5 and
2 plugs M25 x 1,5 are part of the delivery.
2nd cable gland upon request.
Mounting: By means of 2 screws.

Electrical Data

Rated Voltage 690V AC, 220V DC
Switching capacities

AC-1	16 A	690 V
AC-15	16 A	415 V
AC-3	8 A	500 V
AC-3	4 A	690 V
DC-1	10 A	24 V
DC-1	6 A	60 V
DC-1	10 A	110 V ¹⁾
DC-1	10 A	220 V ²⁾

Number of poles: 2-pole

1) 2 contacts connected in series
2) 3 contacts connected in series

8040/.



II 2 G Ex de IIC
T6 Gb

II 2 D Ex tb IIIC
T80°C Db

IP65



for voltages up to 690 V

EU-Type Examination Certificate:

PTB 01 ATEX 1105

Marking:

II 2 G Ex de IIC T6 Gb
II 2 D Ex tb IIIC T80° Db

Ignition protection: e (increased safety)

Rated voltage: 690 V AC, 220V DC

Rated current: max. 16 A

Permissible ambient temperature:
-20 °C bis +40 °C.

Article No.	Type	Switch version	Ident no.	Weight ca. [kg]
80300 0003	8040/A	ON-OFF 2 poles	8040/11-V30-33-B	0,60
80300 0004	8040/W	Pole changing switch	8040/11-V30-35-B	0,62

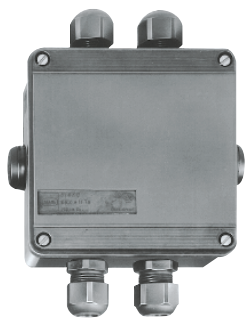

Explosion-Protected Junction Box Series 8118...

Applications:

For transmission and distribution of electrical energy in hazardous areas of Zones 1 and 2.

Design:

Housing: Made from impact resistant glass fibre reinforced polyester resin.

Connection terminals: 5 hood-type terminals (1 of them serves for earth connection) for a max. conductor size of 2 x 6.0 mm².

Cable entry:

8118/4:

4 cable glands M25 x 1,5 +2 plugs M25 x 1,5.

8118/6:

6 cable glands M25 x 1,5

Mounting system:

See dimensional drawings.

8118/4

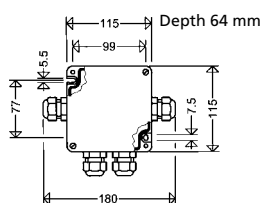

8118/6

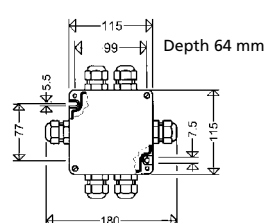

8118/.



II 2 G Ex e IIC
T5/T6 Gb

II 2 D Ex tb IIIC
T80°C/T95°C Db

IP66



voltages up to 750 V

EU-Type Examination Certificate:

PTB 99 ATEX 3103

Marking:

II 2 G Ex e IIC T5/T6 Gb
II 2 D Ex tb IIIC T80°C/T95°C Db

Ignition protection: e (increased safety)

Rated voltage: 750V AC

Permissible ambient temperature:

T6: -40 °C bis +40 °C
T5: -40 °C bis +55 °C

Rated current: max. 35 A

Article No.	Type	Cable gland	Weight ca. [kg]
81180 0001	8118/4	4 x M25 x 1,5	0,57
81180 0002	8118/6	6 x M25 x 1,5	0,61



Waterproof Light Fittings

Quality knows no compromises

Waterproof light fittings have a wide scope of applications. Thus, a light system shall meet various requirements, from simple storage rooms to industrial applications with extreme ambient conditions and temperatures, mechanical and chemical impacts.

Requirements are as various as solutions which SCHUCH offers being an experienced specialist in this field. As a result, a very wide range of light fittings has been designed for special applications at workshops and in production areas.

Numerous excellent references in all industry branches witness SCHUCH's innovative strength, competence and reliability. Our customers appreciate the proverbial high quality of SCHUCH products for over 125 years.

Our customers can also rely on it with regard to all light fittings with the new LED technology. Quality knows no compromises.

FROM WATERPROOF PORCELAIN LIGHT FITTINGS TO WATERPROOF LED LIGHT FITTINGS

1895

Foundation of the company. Production of the first waterproof porcelain lamp holder for incandescent lamps. Production of first porcelain and hand light fittings with protective glass for damp locations, namely for breweries, leather and chemical industries.

1934

SCHUCH launches the first gas-tight pendant lamp ("completely hermetically sealed"). Further "special lights" and "special mountings" such as barrel illuminators, barn and cellar switches follow.

1949

Production of first waterproof light fittings without diffusers for fluorescent tubes.

1952/53

Production of industry's first waterproof light fitting made of fiberglass-reinforced polyester. Launching own production of "PREPREG" and in-house production of fiberglass-reinforced polyester housings.

1972

Start of production of legendary waterproof of light fittings series 161/162, which, in sub-subsequent years, developed to the waterproof light fitting for severe industrial applications.

1975

Foamed polyurethane gasket is used for the first time instead of widespread conventional rubber seals.

1995

The range of waterproof light fittings extends by including special industry solutions for severe applications in the industry and at workshops. In the following years, an extensive program developed out of this, which impressively documents the competence and know-how of SCHUCH.

2007

Industry's first waterproof light fitting for unprotected outdoor installation. A unique selling point that shows the high quality of SCHUCH lights.

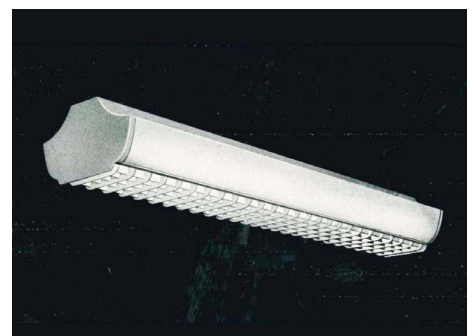
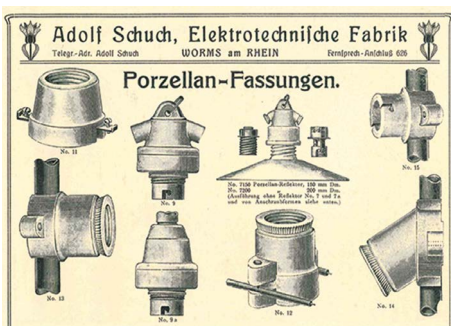

Dustproof/Waterproof Light Fittings

Product	Series	Page
Light management		
LIMAS Air - radio-based light management system		78
LIMAS Line - wired light management system		79
Light fittings with diffuser		
PROXIMA	161PX...	80-89
• with integrated motion sensor	... SENS	82-84
• with smart LIMAS Air radio light control	... CS	84
• for high ambient temperatures	... H50	84
• for low ambient temperatures	... T40	85
• for wide temperature ranges	... T40 / H70	85
• for unprotected outdoor installation	... AUS	85
• with optics for rack aisles / workplace	... TB / T	86
• for food industry areas	... IFS / LM	86-87
• highly efficient design	... HE	88
• for use in hazardous areas	... ER / HR	88
• variable setting of the luminous flux	... VARIO	81/85/87
• FastConnect (quick mounting system)	... FC	89
Series 161/162...	161/162...	90-98
• with integrated motion sensor	... SENS	92-93
• with narrow-wide optics	... TB	94
• for high ambient temperatures	... H50	94
• for wide temperature ranges	... T40 / H70	94
• for unprotected outdoor installation	... AUS	95
• for food industry areas	... IFS / LM	95-96
• for use in hazardous areas	... ER / HR	97
• with DB listing	... DB	97
• variable setting of the luminous flux	... VARIO	91/95/96
• FastFix/FastConnect (mounting system)	... FF / FC	98
Series 144...	144...	99-100
<i>Extremely robust Central Locking System</i>		
• for unprotected outdoor installation	... AUS	100
Series 163/164... Generation 2	163/164... G2	101-105
• for food industry areas	... IFS	102
• with integrated motion sensor	... SENS	103-104
• for wide temperature ranges	... T40/H50	105
• for swimming pools	... VARIO SBL	105
• variable setting of the luminous flux	... VARIO	102/105
Series 161/162... RLED OV	161/162...	106
163/164... RLED OV	163/164...	
<i>for LED-Retrofit lamps</i>		
LUXANO 2 / VARIO	167... G2	107-114
• highly efficient design	... HE VARIO	108
• for unprotected outdoor installation	... AUS/VARIO	108
• for food industry areas	... IFS/VARIO	109
• FastConnect (quick mounting system)	... VARIO FC	109
• with smart LIMAS Air radio light control	... HE CS	112
• for wide temperature ranges	... T40 / H50	112
• particularly humid rooms	... HL	112
• for agriculture and animal husbandry	... LW	113
... with DALI interface	... ER DIMD	113
Oval-shaped light fitting		
Series 3610...	3610...	115
Compact LED fittings		
Series 3611...	3611...	116
Series 164KL... G2	164KL... G2	117
Series 130/131... G2	130/131... G2	118
Tubular light fittings		
PRIMO XR	107...	119-120
• for agriculture and animal husbandry	... LW	120
TUBEO	110...	121-122
• for high ambient temperatures	... H50	122
Sheet steel light fittings		
Series 190...	190...	123
Series 185...	185...	124-126
Vandal proof light fitting		
SEGURO	142...	127-128
Carrier rails	TRS / AL	129-130
Through wirings	DV	131

LED TECHNOLOGY

2007

The first waterproof LED light fittings (low power compact light fittings) are added to in the product range.

2014

With light fitting series 161 VARIO SCHUCH introduces industry's first waterproof light fitting with adjustable luminous flux.

2015/16

Development of an LED light fitting series for wide temperature ranges from -40 °C to +65 °C, which are particularly suitable for worldwide use in climate zones with extreme temperature fluctuations.

2019-2021

SCHUCH intensely investigates the influence of harmful gases on LED light fittings. This has resulted in the **RESISTANT range of light fittings** with the characteristics
ER = increased protection
HR = high protection
XR = extremely tight
and the new PRIMO XR light fitting.

2022

A legend turns 50! With the **PROXIMA 161PX...** SCHUCH presents the next generation of the legendary 161/162,... dustproof/waterproof light fitting series.

2023/2025

The new PROXIMA and the highly successful LUXANO 2 range are being extended to include a number of **innovative variants**. With **LIMAS Air and LIMAS Line**, smart light control systems are now available.

2025

Standard versions of the LUXANO 2 will become part of the new **BestSelect** program, a selection of proven SCHUCH light fittings for everyday use.

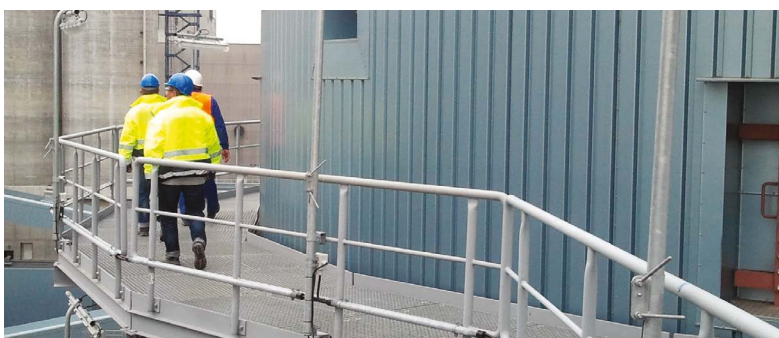

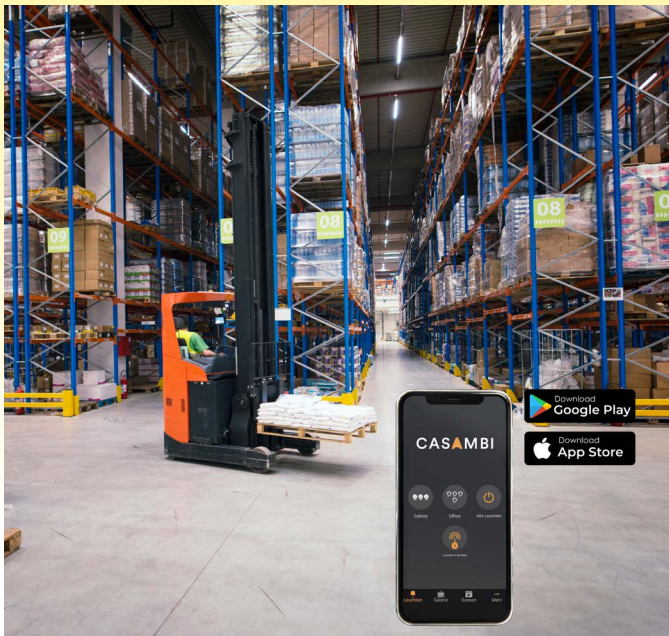









radio-based light management system for moisture-proof luminaires (version ...CS)

With the radio-based LIMAS Air light management system, you can make your lighting system smart in no time at all - and without any additional installation work. No additional radio module is required to control moisture-proof luminaires. Everything you need for a networked lighting environment is already included in the luminaires (version ...CS). Based on CASAMBI® wireless technology and the 2.4 GHz radio standard, the lighting system can be controlled reliably with low power consumption and a long range. The system is set up simply and intuitively using a smartphone or tablet with the free CASAMBI® app. The following sensors and actuators can be integrated and flexibly grouped.

For further details and properties, see the chapter on Light Management Systems.

System accessories

Type	Art.-No.		
LACA BM/DS IR10	90547 9014	CASAMBI® motion and light sensor for mounting heights of 2.0 – 10.0 m and a maximum detection range of 24.0 m in diameter	
LACA BM/DS IR16	90547 9013	CASAMBI® motion and light sensor for mounting heights of 5.0 – 16.0 m and a maximum detection range of 19.0 m x 30.0 m	
LACA BM/DS IR20	90547 9007	CASAMBI® motion and light sensor for mounting heights up to 20.0 m and a maximum detection range of 5.0 m in diameter	
LACA BM/DS IR3	90547 9008	CASAMBI® motion and light sensor for mounting heights up to 2.2 m and a maximum detection range of 5.0 m in diameter	
LACA FM DALI PS 120	90547 9010	CASAMBI® radio module with DALI power supply and broadcast control for up to 60 ECGs (total current 120 mA). Power supply 230 V	
LACA TAST4 AP	90547 9011	Battery-free, 4-button CASAMBI® radio switch. Actuating the switch generates the energy required to power the switch electronics	
LACA TASTIF4 UP	90547 9009	CASAMBI® push-button interface for connecting up to 4 volt-free push-button inputs. Designed for installation in a flush-mounted wall box	
RFL LACA FM DS	90546 9013	CASAMBI® radio module with light sensor for RFL sockets	



With LIMAS Line, you can create an easy-to-use wired light management system with the help of DIMD luminaire versions and additional system accessories. It creates ideal conditions for flexible use of space, focusing in particular on people's different needs and reducing operating costs at the same time.

LIMAS Line BASIC

Wired light management system for small DALI projects



LIMAS Line BASIC enables fully automated, dynamic light in conjunction with the corresponding sensors. Configuration is carried out using a smart end device (Android or iOS) via a wireless connection. This only requires a free app with which the room to be illuminated can be recreated and equipped and configured with luminaires, sensors and push-buttons. For further details and properties, see the chapter on light management systems.

LIMAS Line PRO

Wired light management system with emergency lighting monitoring / building management integration

LIMAS Line PRO offers extended options and additional functions. In addition to DIMD luminaires, all self-contained emergency luminaires (MA-Z) in the SCHUCH portfolio can also be controlled and monitored. Configuration and control are carried out via PC without additional software - a browser is sufficient. The connection between the PC and LIMAS Line PRO can be realised either via an existing network or by establishing a peer-to-peer connection. An Internet connection is not required. For further details and properties, see the chapter on light management systems.

System accessories

Type	Art.-No.		
LL BM/DS HF4	90545 0040	High-frequency DALI-2 motion sensor with integrated light sensor for mounting heights of 2.0 – 4.0 m and a maximum detection range of 8.0 m in diameter	
LL BM/DS IR14	90545 0036	Infrared DALI-2 motion sensor with integrated light sensor for mounting heights of 4.0 - 14.0 m	
LL BM/DS IR16	90545 0037	Infrared DALI-2 motion sensor with integrated light sensor for mounting heights of 4.0 - 16.0 m	
LL BM/DS IR3	90545 0038	Infrared DALI-2 motion sensor with integrated light sensor for vertical wall mounting, suitable for installation heights of 1.8 – 2.5 m	
LL BM/DS IR4	90545 0035	Infrared DALI-2 motion sensor with integrated light sensor for mounting heights of 2.5 – 4.0 m	
LL BM/DS IR5	90545 0039	Infrared DALI-2 motion sensor with integrated light sensor for mounting heights of 2.5 – 5.0 m and a maximum detection range of 6.0 m x 23.0 m	
LL DALI PS240	90545 0016	DALI bus power supply with up to 240 mA maximum output current	
LL TASTIF4 UP	90545 0015	DALI-2 push-button interface for connecting up to 4 volt-free push-button inputs. Designed for installation in a flush-mounted wall box	
LL XR DS4	90545 0045	DALI-2 light sensor in encapsulated housing for areas exposed to harmful gases and mounting heights of 2.0 to 4.0 m	
LLBC CON	90545 0005	DALI-2 controller for controlling up to 64 devices	
LLPO AKTOR 4X10	90545 0041	DALI-2 actuator with 4 volt-free outputs (max. 10 A). Suitable for signaling test states and system statuses of self-contained emergency luminaires	
LLPO CON	90545 0031	DALI-2 controller for controlling up to 192 devices across 3 DALI buses. Monitoring of self-contained emergency luminaires possible	



PROXIMA

Dustproof/Waterproof LED Light Fitting with Diffuser Serie 161PX... / 161PX... VARIO

Applications:

Humid, wet and dusty rooms in trade, commerce and industry, multi-storey car parks, underground car parks, cold stores, cold rooms and walk-in cold rooms, covered outdoor areas, etc. (Please enquire in the event of humid, cold ambient conditions with low duty cycles and the presence/ occurrence of chemical substances)

Design:

Housing: Glass fibre reinforced polyester resin, foamed silicone gasket.

Diffuser: Injection-molded acrylic glass, frosted for glare limitation.

Closure: Three-part plastic safety clips (KKS) to ensure protection against accidental contact.

Reflector: Aluminium, painted, can be suspended or removed and carries the electrical components.

Connection: 3-pole

Cable entries: 3 plugs M20, loop in-out possible without further modification.

Mounting: 2 stainless steel retaining clips, 2 brackets for chain suspension, holes pre-pressed for direct fixing, sealing and pressure disks included in scope of deliver.

VARIO versions with variable setting of the luminous flux

Applications:

Factories in which, for reasons of maximum standardization and economic storage, only one type of damp-proof luminaire is to be used, which can be used for a wide variety of lighting tasks due to its variably adjustable luminous flux.

Design:

But with DIP switch for setting the luminous flux without tools. The luminaire luminous flux can be set to almost any value between 1,660 lm and 6,070 lm. Depending on the set luminous flux, the power consumption of the light fitting and the maximum permissible ambient temperature change.

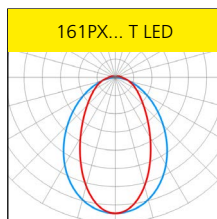
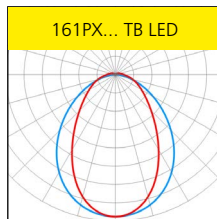
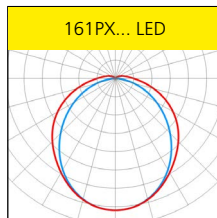
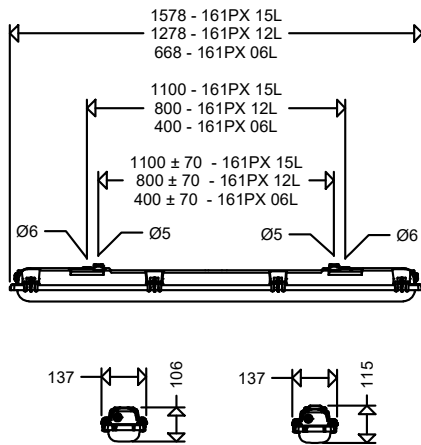

Technical data:

LED: Linear modules 4,000 K, CRI > 80, service life $L_{90} > 50,000$ h at 25 °C ambient temperature, service life $L_{80} > 70,000$ h and $L_{70} > 100,000$ h at max. ambient temperature

ECG: 220-240 V, 50/60 Hz, overload and short-circuit protection

Ambient temperature: -20 °C (-40 °C for types ...T40) up to ..°C see article table

Options:

- 2,200 K, 2,700 K, 3,000 K, 5,000 K, 6,500 K; light colours (822, 827, 830, 850, 865)
- 1,800 K; light colour (518), amber for insect-friendly lighting in outdoor areas etc.
- high colour rendering index $R_a > 90$
- green LEDs, for lighting potato stores
- coloured LEDs, for signal applications
- through-wiring (DV)
- cable entry M25 x 1,5 mm²

- rear cable entry
- cover made of polycarbonate (PC), frosted
- stainless steel clips (KE)
- protection class II (SKII)
- vibration-resistant design
- power reduction with control phase (LR)
- constant luminous flux function (CL)
- additional overvoltage protection

Standard cable entries for looping the mains cable on one side (loop in / loop out):

We deliver the light fittings with 2 cable entries on one small side. This feature allows an optimal adjustment to all local conditions and it will consequently save the typical quite expensive through wiring system. (Surcharge for 5-pole version).



Product highlights of the VARIO version:

- universally usable due to variable setting of the luminous flux, depending on the requirement
- simple and quick adjustment on-site without tools
- can be changed at any time (e.g. change of use of the premises with new requirements in regard to the level of illumination)
- maximum standardisation and most economical warehousing

General product highlights of the 161PX... series:

- high-impact resistant housing, wall thickness 1.8 mm
- diffuser with very high mechanical stability, wall thickness 2.0 mm
- safety clips to ensure protection against contact
- FastFix quick mounting system with retaining clips made of stainless steel
- flexible mounting with movable retaining clips
- front-side in/out wiring (3-pole) possible as standard due to 2 entries on one side
- variable cable entry possible through additional entries on the top of the enclosure at the front or in the centre, centring holes available
- homogeneous illumination by using frosted diffusers
- highest flexibility due to almost unlimited modification possibilities
- sustainable, control gear and LED-module replaceable by qualified personnel on-site
- future proof by using standardised LED-modules (Zhaga) and long-term availability of spare parts

Properties, limitations and details for controlling LED-light fittings:

See "Technical Supplement"

All data are correct at the time of printing. Actual technical data can be found under www.schuch.de.

Article no.	Type	Quantity of ECG	Connected load [W]	Luminous flux [lm]	Luminous efficacy [lm/W]	Ambient temperature max. [°C]	Substitute for ca. *	Weight [kg] without packing material
-------------	------	-----------------	--------------------	--------------------	--------------------------	-------------------------------	----------------------	--------------------------------------

161PX... / 161PX... VARIO



16130 0001	161PX 06L12	1	10	1.410	141	40	1 x 18W	1,7
16130 0004	161PX 06L20	1	16	2.330	146	40	2 x 18W	1,7
16130 0002	161PX 12L22	1	15	2.440	163	40	1 x 36W	2,8
16130 0005	161PX 12L42	1	27	4.300	159	40	2 x 36W	2,8
16130 0007	161PX 12L60	1	39	6.070	156	40	2 x 58W	2,8
16130 0009	161PX 12L120	1	77	12.140	158	35	2 x 80 bzw. 3 x 58W	3,1
16130 0003	161PX 15L34	1	21	3.520	168	40	1 x 58W	3,4
16130 0006	161PX 15L60	1	39	6.270	161	40	2 x 58W	3,4
16130 0008	161PX 15L75	1	49	7.590	155	40	> 2 x 58W	3,4
16130 0010	161PX 15L150	1	93	15.180	163	35	4 x 58W	3,7
16130 0127	161PX 15L200	1	122	19.400	159	35	6 x 58W	4,2
16130 0090	161PX 12L VARIO	1	11	1.660	151	45	1 x 18W	2,8
			15	2.440	163	40	1 x 36W	
			22	3570 ¹⁾	162	40	1 x 58W	
			27	4.330	160	40	2 x 36W	
			39	6.070	156	35	2 x 58W	

1) Factory setting

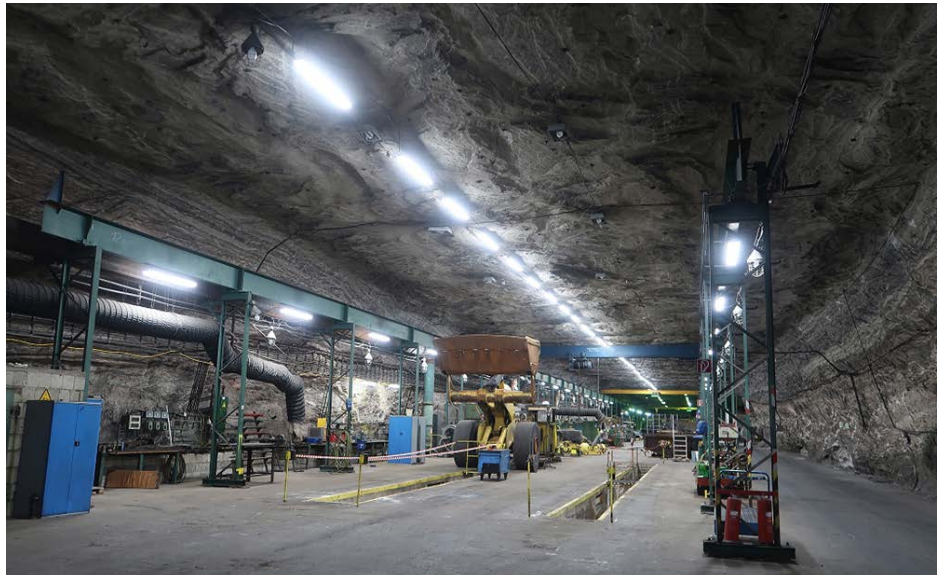

Dustproof/Waterproof Light Fittings

161PX... DIMD



dimmable via DALI interface

Design:

Same as standard version, but with DALI-2-ECG and 2 additional clamping points. Dimming range 1-100 %. Compatible with LIMAS Line Light Management System.

16130 0011	161PX 06L12 DIMD	1	10	1.410	141	40	1 x 18W	1,7
16130 0014	161PX 06L20 DIMD	1	16	2.330	146	40	2 x 18W	1,7
16130 0012	161PX 12L22 DIMD	1	15	2.440	163	40	1 x 36W	2,8
16130 0015	161PX 12L42 DIMD	1	27	4.300	159	40	2 x 36W	2,8
16130 0017	161PX 12L60 DIMD	1	39	6.070	156	40	2 x 58W	2,8
16130 0019	161PX 12L120 DIMD	1	77	12.140	158	35	2 x 80 bzw. 3 x 58W	3,1
16130 0013	161PX 15L34 DIMD	1	21	3.520	168	40	1 x 58W	3,4
16130 0016	161PX 15L60 DIMD	1	39	6.270	161	40	2 x 58W	3,4
16130 0018	161PX 15L75 DIMD	1	49	7.590	155	40	> 2 x 58W	3,4
16130 0020	161PX 15L150 DIMD	1	93	15.180	163	35	4 x 58W	3,7
16130 0129	161PX 15L200 DIMD	1	122	19.400	159	35	6 x 58W	4,2

* The given information is for rough orientation only. In each individual case a lighting calculation is necessary.



161PX... DIMC/SENS - General information

Applications:

Areas in which the lighting is controlled via motion sensors or door contacts, e.g. storage areas, rack aisles, parking garages etc.

SENS luminaires: are controlled by L' and can generate L'

DIMC luminaires: are controlled by L'

Design:

As standard version but with DALI-2 ECG and additional terminal point, labeled L', optionally with HF sensor (SENS types), see table.

	Clamping point L'	powerless switching	Integrated sensor	Switches off after 30 minutes
161PX... DIMC	x	x	–	–
161PX... DIMC-Z30	x	x	–	x
161PX... SENS	x	x	x	–
161PX... SENS-Z30	x	x	x	x

Product highlights:

- simple installation and commissioning
- no software or apps required for operation
- only one mains-insulated control cable is required
- "Stand-alone operation" of the SENS luminaires possible, no control phase is required for this
- large energy saving potential through
 - Power consumption reduced by up to 90 % in dimming mode
 - shorter operating time for Z30 versions
- no gateway required
- use of external sensors possible

Technical data:

Control: Any number of DIMC or SENS luminaires can be controlled via the control phase of the SENS luminaires. Switching is powerless. If movement is no longer detected by a SENS luminaire or an external sensor detected (depending on the set hold time), the control phase switches to 0 V and all luminaires connected to the control phase dim to 10 % (factory setting). Please observe the installation instructions in the Technical Supplement.

Programming: the following parameters, among others, can be changed on the LED control gear via the NFC interface: Luminous flux, dimming ramp, switch-off time. Programming can be done via smartphone and free app.

Detection range of the HF sensor: Depending on the light point height, the detection range is 1-5 m:

- Light point height approx. 2.5 m: Detection area approx. 3 m diameter
- Light point height approx. 5 m: Detection area max. 5 m diameter

Structures such as concrete pillars can restrict the detection area. Materials such as drywall can be penetrated.

Factory settings:

- Standard sensor hold time (X): 5 minutes can be set (see setting options), only for SENS types
- Dimming ramp (Y): 30 seconds, for DIMC and SENS types
- Reduced operation (L' = 0 V): 10 % luminous flux if no activity is detected, for SENS and DIMC types
- Automatic switch-off deactivated (Z), luminaire never switches off.
- For further information, see illustration "Luminous flux profile of the luminaire" for 161PX... DIMC.

Setting options for SENS luminaires: Via potentiometer on the sensor or optionally via IR remote control (article number 90295 9000):

- Sensitivity of the sensor to avoid unwanted detections in the edge area
- Hold time of the sensor from 10 seconds to 30 minutes, with IR remote control up to 60 minutes

Ambient temperature: -20 °C to see table

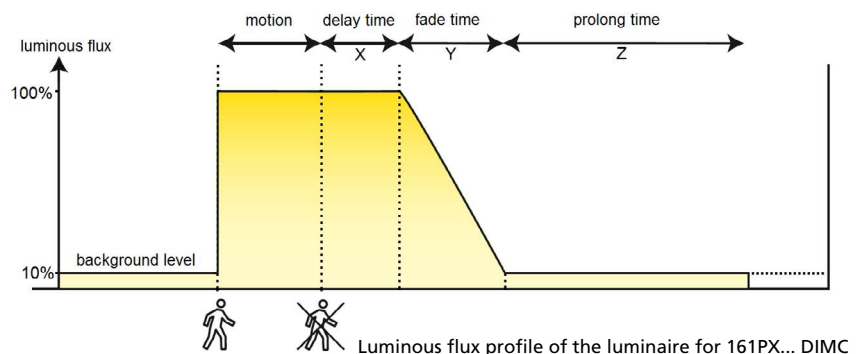

Article no.	Type	Quantity of ECG	Connected load [W]	Luminous flux [lm]	Luminous efficacy [lm/W]	Ambient temperature max.[°C]	Substitute for ca. *	Weight [kg] without packing material
-------------	------	-----------------	--------------------	--------------------	--------------------------	------------------------------	----------------------	--------------------------------------

161PX... DIMC



dimmable via Corridor Mode

Factory settings DIMC types:

– Automatic switch-off deactivated, light never switches off.

16130 0022	161PX 12L22 DIMC	1	15	2.440	163	40	1 x 36W	2,8
16130 0025	161PX 12L42 DIMC	1	27	4.300	159	40	2 x 36W	2,8
16130 0027	161PX 12L60 DIMC	1	39	6.070	156	40	2 x 58W	2,8
16130 0029	161PX 12L120 DIMC	1	77	12.140	158	35	2 x 80 bzw. 3 x 58W	3,1
16130 0023	161PX 15L34 DIMC	1	21	3.520	168	40	1 x 58W	3,4
16130 0026	161PX 15L60 DIMC	1	39	6.270	161	40	2 x 58W	3,4
16130 0028	161PX 15L75 DIMC	1	49	7.590	155	40	> 2 x 58W	3,4
16130 0030	161PX 15L150 DIMC	1	93	15.180	163	35	4 x 58W	3,7
16130 0130	161PX 15L200 DIMC	1	122	19.400	159	35	6 x 58W	4,2

161PX... DIMC-Z30



dimmable via Corridor Mode and automatic switch-off function (30 minutes)

Factory settings different from DIMC-Z30 types:

– Automatic switch-off activated: 30 minutes 10 % background level, then standby mode (0 %).

16130 0032	161PX 12L22 DIMC-Z30	1	15	2.440	163	40	1 x 36W	2,8
16130 0035	161PX 12L42 DIMC-Z30	1	27	4.300	159	40	2 x 36W	2,8
16130 0037	161PX 12L60 DIMC-Z30	1	39	6.070	156	40	2 x 58W	2,8
16130 0039	161PX 12L120 DIMC-Z30	1	77	12.140	158	35	2 x 80 bzw. 3 x 58W	3,1
16130 0033	161PX 15L34 DIMC-Z30	1	21	3.520	168	40	1 x 58W	3,4
16130 0036	161PX 15L60 DIMC-Z30	1	39	6.270	161	40	2 x 58W	3,4
16130 0038	161PX 15L75 DIMC-Z30	1	49	7.590	155	40	> 2 x 58W	3,4
16130 0040	161PX 15L150 DIMC-Z30	1	93	15.180	163	35	4 x 58W	3,7
16130 0131	161PX 15L200 DIMC-Z30	1	122	19.400	159	35	6 x 58W	4,2

161PX... SENS



DIMC version with integrated motion sensor

Design:

As DIMC version, but with integrated motion sensor. As a master luminaire, the luminaire can control all DIMC luminaires connected to it.

Factory settings SENS types:

– Automatic switch-off deactivated, light never switches off.

16130 0042	161PX 12L22 SENS	1	15	2.440	163	40	1 x 36W	2,9
16130 0045	161PX 12L42 SENS	1	27	4.300	159	40	2 x 36W	2,9
16130 0047	161PX 12L60 SENS	1	39	6.070	156	40	2 x 58W	2,9
16130 0049	161PX 12L120 SENS	1	77	12.140	158	35	2 x 80 bzw. 3 x 58W	3,2
16130 0043	161PX 15L34 SENS	1	21	3.520	168	40	1 x 58W	3,5
16130 0046	161PX 15L60 SENS	1	39	6.270	161	40	2 x 58W	3,5
16130 0048	161PX 15L75 SENS	1	49	7.590	155	40	> 2 x 58W	3,5
16130 0050	161PX 15L150 SENS	1	93	15.180	163	35	4 x 58W	3,8
16130 0132	161PX 15L200 SENS	1	122	19.400	159	35	6 x 58W	4,2

* The given information is for rough orientation only. In each individual case a lighting calculation is necessary.



Dustproof/Waterproof Light Fixtures

Article no.	Type	Quantity of ECG	Connected load [W]	Luminous flux [lm]	Luminous efficacy [lm/W]	Ambient temperature max. [°C]	Substitute for ca. *	Weight [kg] without packing material
-------------	------	-----------------	--------------------	--------------------	--------------------------	-------------------------------	----------------------	--------------------------------------

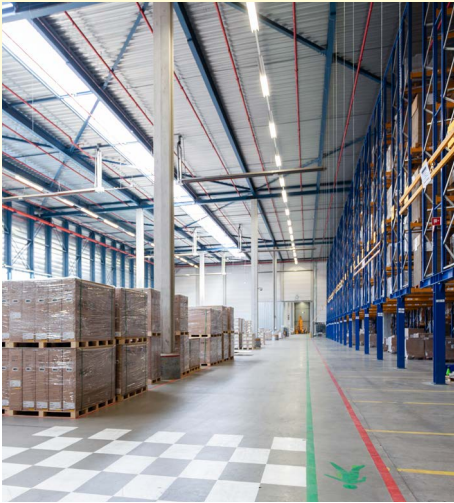

161PX... SENS-Z30



DIMC-Z30 version with integrated motion sensor and automatic switch-off (30 minutes)

Design:

As DIMC-Z30 version, but with integrated motion sensor. As a master luminaire, the luminaire can control all DIMC-Z30 luminaires connected to it.

Factory settings SENS-Z30 types:

- Automatic switch-off activated: 30 minutes 10 % background level, then standby mode (0 %).

16130 0052	161PX 12L22 SENS-Z30	1	15	2.440	163	40	1 x 36W	2,9
16130 0055	161PX 12L42 SENS-Z30	1	27	4.300	159	40	2 x 36W	2,9
16130 0057	161PX 12L60 SENS-Z30	1	39	6.070	156	40	2 x 58W	2,9
16130 0059	161PX 12L120 SENS-Z30	1	77	12.140	158	35	2 x 80 bzw. 3 x 58W	3,2
16130 0053	161PX 15L34 SENS-Z30	1	21	3.520	168	40	1 x 58W	3,5
16130 0056	161PX 15L60 SENS-Z30	1	39	6.270	161	40	2 x 58W	3,5
16130 0058	161PX 15L75 SENS-Z30	1	49	7.590	155	40	> 2 x 58W	3,5
16130 0060	161PX 15L150 SENS-Z30	1	93	15.180	163	35	4 x 58W	3,8
16130 0133	161PX 15L200 SENS-Z30	1	122	19.400	159	35	6 x 58W	4,2



161PX... CS



with smart LIMAS Air light control via radio

Applications:

Areas where no DALI lines are available or planned, but the luminaires are to be controlled intelligently.

Design:

As standard version, but with CASAMBI®-enabled control gear for smart lighting control.

Explanations on smart light control as well as further system accessories (sensors / switches / pushbuttons etc.) can be found in the catalog section „Light Management - LIMAS Air“.

Product highlights:

- each individual luminaire separately controllable
- compatible with all LIMAS Air system accessories
- convenient configuration and control via radio using free smartphone app (Android and iOS)
- no gateway and no internet connection required
- extensive portfolio of sensors and actuators
- significant reduction of operating costs and CO₂ reduction

16130 0061	161PX 12L42 CS	1	27	4.300	159	40	2 x 36W	2,8
16130 0062	161PX 15L60 CS	1	39	6.270	161	40	2 x 58W	3,5

161PX... H50



for high ambient temperatures up to +50 °C

Applications:

Power plants, steel plants, machine-oriented areas, areas with high process waste heat, areas close to the ceiling with accumulating heat etc.

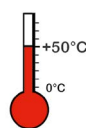

16134 0001	161PX 06L12 H50	1	10	1.410	141	50	1 x 18W	1,7
16134 0004	161PX 06L20 H50	1	16	2.330	146	50	2 x 18W	1,7
16134 0002	161PX 12L22 H50	1	15	2.440	163	50	1 x 36W	2,8
16134 0005	161PX 12L42 H50	1	27	4.300	159	50	2 x 36W	2,8
16134 0003	161PX 15L34 H50	1	21	3.520	168	50	1 x 58W	3,4
16134 0006	161PX 15L60 H50	1	39	6.270	161	50	2 x 58W	3,4

* The given information is for rough orientation only. In each individual case a lighting calculation is necessary.

Article no.	Type	Quantity of ECG	Connected load [W]	Luminous flux [lm]	Luminous efficacy [lm/W]	Ambient temperature max. [°C]	Substitute for ca. *	Weight [kg] without packing material
-------------	------	-----------------	--------------------	--------------------	--------------------------	-------------------------------	----------------------	--------------------------------------



161PX... T40



for ambient temperatures down to -40 °C

Applications:

Cooling chambers, frozen food stock etc.

16134 0012	161PX 12L22 T40	1	15	2.440	163	40	1 x 36W	2,8
16134 0015	161PX 12L42 T40	1	27	4.300	159	40	2 x 36W	2,8
16134 0013	161PX 15L34 T40	1	21	3.520	168	40	1 x 58W	3,4
16134 0016	161PX 15L60 T40	1	39	6.270	161	40	2 x 58W	3,4

161PX... T40 / H..



for wide temperature ranges from -40 °C up to +60°C / 70°C

Applications:

Climatic chambers, material container, test benches in the automotive industry, regions with extreme temperature fluctuations etc.

Design:

As standard version, but:

Diffuser: Injection-molded polycarbonate, frosted for glare limitation.

Closure clips: Stainless steel (KE), incl. 2 safety clips (KES) to ensure protection against contact.

16134 0022	161PX 12L22 T40 H70	1	15	2.440	163	70	1 x 36W	2,8
16134 0025	161PX 12L42 T40 H70	1	27	4.300	159	70	2 x 36W	2,8
16134 0023	161PX 15L34 T40 H70	1	21	3.520	168	70	1 x 58W	3,4
16134 0026	161PX 15L60 T40 H60	1	39	6.270	161	60	2 x 58W	3,4

161PX... AUS / 161PX VARIO AUS



for application in unprotected outdoor areas

Applications:

In protected and unprotected outdoor areas and industrial plants, mounted to walls, ceilings, catwalks and steel structures, pipe brackets, grating, under canopies, bus stops, train stations, subways, construction sites, etc.

Design:

As type 161PX..., but:

Diffuser: UV proof

Pressure compensation element: M20

Entries: 2 glands M20 at one small side, pressure compensation element M20 at the other small side, 1 screw plug M20.

Mounting:

Ceiling and horizontal wall mount or mounting to outreaches, poles, steel structures, catwalks, etc. by means of pipe clamps. For vertical mounting please consult us.

Advantages of the AUS design:

- glass fibre reinforced polyester housing, durable resistant against UV-radiation and chemical components
- our injection-molded PMMA-covers are extremely UV-resistant and robust (wall thickness 2.0 mm)
- gasket are UV-, ozone-, weather-, chemically resistant and non-aging
- pressure compensation element provides controlled venting and thus protects against condensation
- the fitting can be installed in canopied as well as in entirely open outdoor areas

16131 0001	161PX 06L12 AUS	1	10	1.410	141	40	1 x 18W	1,7
16131 0004	161PX 06L20 AUS	1	16	2.330	146	40	2 x 18W	1,7
16131 0002	161PX 12L22 AUS	1	15	2.440	163	40	1 x 36W	2,8
16131 0005	161PX 12L42 AUS	1	27	4.300	159	40	2 x 36W	2,8
16131 0007	161PX 12L60 AUS	1	39	6.070	156	40	2 x 58W	2,8
16131 0009	161PX 12L120 AUS	1	77	12.140	158	35	2 x 80 bzw. 3 x 58W	3,1
16131 0003	161PX 15L34 AUS	1	21	3.520	168	40	1 x 58W	3,4
16131 0006	161PX 15L60 AUS	1	39	6.270	161	40	2 x 58W	3,4
16131 0008	161PX 15L75 AUS	1	49	7.590	155	40	> 2 x 58W	3,4
16131 0010	161PX 15L150 AUS	1	93	15.180	163	35	4 x 58W	3,7
16131 0127	161PX 15L200 AUS	1	122	19.400	159	35	6 x 58W	4,2
16131 0090	161PX 12L VARIO AUS	1	11	1.660	151	45	1 x 18W	2,8
			15	2.440	163	40	1 x 36W	
			22	3570 ¹⁾	162	40	1 x 58W	
			27	4.330	160	40	2 x 36W	
			39	6.070	156	35	2 x 58W	

1) Factory setting

* The given information is for rough orientation only. In each individual case a lighting calculation is necessary.

Notes:

The light fitting is **not suitable** for use in extremely exposed locations with high mechanical stress (wind load) or infrequent or occasional use (e.g. maintenance or inspection lighting).

For use in extremely exposed locations with high mechanical loads (wind load), we recommend our series **144 ... AUS** or **107 ... G2 (PRIMO XR)**.

For infrequent or occasional use, we recommend our series **107 ... G2 (PRIMO XR)** or the installation of a weather protection cover over the luminaire.

When mounting the light fittings on bracket poles or tubular beams/pipes always use original SCHUCH pipe clamps with support (see accessories).



Article no.	Type	Quantity of ECG	Connected load [W]	Luminous flux [lm]	Luminous efficacy [lm/W]	Ambient temperature max. [°C]	Substitute for ca. *	Weight [kg] without packing material
-------------	------	-----------------	--------------------	--------------------	--------------------------	-------------------------------	----------------------	--------------------------------------

161PX... TB / T



with optics for rack aisles and workplace lighting

Applications:

High-bay warehouse, rack storage aisles, workplace-related lighting, etc.

Design:

Same as standard versions 161PX..., but with narrow-wide beam (TB) or narrow beam (T) optics.

16130 0173	161PX 12L120TB	1	77	11.470	149	35	2 x 80 bzw. 3 x 58W	3,5
16130 0174	161PX 15L150T	1	93	15.180	163	35	4 x 58W	4,2
16130 0175	161PX 15L200T	1	122	19.400	159	35	6 x 58W	4,7

Product highlights¹⁾:

- up to 30 % fewer luminaires compared to versions without optics
- up to 30 % energy cost savings
- up to 45% larger luminaire spacing
- significantly lower installation costs

¹⁾ Basis: Lighting design for 12 m high-bay warehouse, aisle width 3 m, luminaire type 161PX 15L200T

Note:

The light fittings in Version IFS are not suitable for cleaning with cleaning agents or disinfectants as well as the cleaning with water-jet units.



161PX... IFS



for application in food industry areas

Applications:

Food industry or food processing factories, suppliers to the food industry who are falling in the International Featured Standard Food, BRC, HACCP or who are subject to comparably strict requirements.

Design:

Same as type 161PX... but:

Diffuser: cover Polycarbonate, frosted.

Closure clips: Stainless steel (KE), incl. 2 safety clips (KES) to ensure protection against contact.

16132 0001	161PX 06L12 IFS	1	10	1.410	141	40	1 x 18W	1,7
16132 0004	161PX 06L20 IFS	1	16	2.330	146	40	2 x 18W	1,7
16132 0002	161PX 12L22 IFS	1	15	2.440	163	40	1 x 36W	2,8
16132 0005	161PX 12L42 IFS	1	27	4.300	159	40	2 x 36W	2,8
16132 0007	161PX 12L60 IFS	1	39	6.070	156	40	2 x 58W	2,8
16132 0009	161PX 12L120 IFS	1	77	12.140	158	35	2 x 80 bzw. 3 x 58W	3,1
16132 0003	161PX 15L34 IFS	1	21	3.520	168	40	1 x 58W	3,4
16132 0006	161PX 15L60 IFS	1	39	6.270	161	40	2 x 58W	3,4
16132 0008	161PX 15L75 IFS	1	49	7.590	155	40	> 2 x 58W	3,4
16132 0010	161PX 15L150 IFS	1	93	15.180	163	35	4 x 58W	3,7
16132 0127	161PX 15L200 IFS	1	122	19.400	159	35	6 x 58W	4,2

* The given information is for rough orientation only. In each individual case a lighting calculation is necessary.

IFS/BRC/VDMA/HACCP

SCHUCH Light Fittings designed for food and beverage industry applications are in accordance with IFS/BRC/VDMA standards. They can be operated without restrictions in operations that must fulfill the HACCP Concept.

Why use PC covers for IFS luminaires?

- splinter-free (in contrast to PMMA)
- risk minimisation, no risk of food contamination (see IFS Standard Food Issue 8, chapter 4.12 risk minimisation)
- extension of the inspection intervals in the risk zones of production

Article no.	Type	Quantity of ECG	Connected load [W]	Luminous flux [lm]	Luminous efficacy [lm/W]	Ambient temperature max. [°C]	Substitute for ca. *	Weight [kg] without packing material
-------------	------	-----------------	--------------------	--------------------	--------------------------	-------------------------------	----------------------	--------------------------------------

Note:
The diffusers of all 161PX... LM luminaires are made from 45% bio-based plastics.



Note:
The colour rendering index Ra does not incorporate the remaining part (R9) in the light spectrum. The standard light colour 840 has only a minor R9 value. For meat processing factories, we recommend the use of our light fitting with light colour 940 (special version), which emits a bigger amount of red light.

161PX... LM / 161PX... VARIO LM



for application in food areas

Applications:

Food industry or food processing factories especially in risky areas of the food production or processing, suppliers to the food industry who are falling in the International Featured Standard Food, BRC or HACCP standards or who are subject to comparably strict requirements (e.g. production of food packaging).

Design:

Same as type 161PX... but:

Diffuser: Shatterproof, high chemical resistance, elements for glare limitation mounted to the reflector.
Closure clips: Stainless steel (KE), incl. 2 safety clips (KES) to ensure protection against contact.

Advantages of the LM version:

- shatterproof diffuser with very high impact resistance (16 Nm!) even at a high continuous operating temperature
- resistant to grease and aggressive cleaning agents, disinfectants and solvents (we recommend the respective cleaning agents and disinfectants to be tested on their resistance. Resistance index on request.)
- Risk minimisation, no risk of food contamination (see IFS Standard Food Issue 8, Chapter 4.12 Risk minimisation)
- Extension of the inspection intervals in the risk zones of production

IFS / BRC / VDMA / HACCP

SCHUCH Light Fittings designed for food and beverage industry applications are in accordance with IFS / BRC / VDMA standards. They can be operated without restrictions in operations that must fulfill the HACCP Concept.

16132 0021	161PX 06L12 LM	1	10	1.410	141	40	1 x 18W	1,7
16132 0024	161PX 06L20 LM	1	16	2.330	146	40	2 x 18W	1,7
16132 0022	161PX 12L22 LM	1	15	2.440	163	40	1 x 36W	2,8
16132 0025	161PX 12L42 LM	1	27	4.300	159	40	2 x 36W	2,8
16132 0027	161PX 12L60 LM	1	39	6.070	156	40	2 x 58W	2,8
16132 0029	161PX 12L120 LM	1	77	12.140	158	35	2 x 80 bzw. 3 x 58W	3,1
16132 0023	161PX 15L34 LM	1	21	3.520	168	40	1 x 58W	3,4
16132 0026	161PX 15L60 LM	1	39	6.270	161	40	2 x 58W	3,4
16132 0028	161PX 15L75 LM	1	49	7.590	155	40	> 2 x 58W	3,4
16132 0030	161PX 15L150 LM	1	93	15.180	163	35	4 x 58W	3,7
16132 0128	161PX 15L200 LM	1	122	19.400	159	35	6 x 58W	4,2
16132 0090	161PX 12L VARIO LM	1	11	1.660	151	45	1 x 58W	2,8
			15	2.440	163	40	1 x 36W	
			22	3570 ¹⁾	162	40	1 x 58W	
			27	4.330	160	40	2 x 36W	
			39	6.070	156	35	2 x 58W	

161PX... LM H50



for high ambient temperatures up to +50 °C

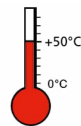

16132 0041	161PX 06L12 LM H50	1	10	1.410	141	50	1 x 18W	1,7
16132 0044	161PX 06L20 LM H50	1	16	2.330	146	50	2 x 18W	1,7
16132 0042	161PX 12L22 LM H50	1	15	2.440	163	50	1 x 36W	2,8
16132 0045	161PX 12L42 LM H50	1	27	4.300	159	50	2 x 36W	2,8
16132 0043	161PX 15L34 LM H50	1	21	3.520	168	50	1 x 58W	3,4
16132 0046	161PX 15L60 LM H50	1	39	6.270	161	50	2 x 58W	3,4

161PX... LM T40



for ambient temperatures down to -40 °C

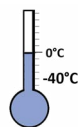

16132 0052	161PX 12L22 LM T40	1	15	2.440	163	40	1 x 36W	2,8
16132 0055	161PX 12L42 LM T40	1	27	4.300	159	40	2 x 36W	2,8
16132 0053	161PX 15L34 LM T40	1	21	3.520	168	40	1 x 58W	3,4
16132 0056	161PX 15L60 LM T40	1	39	6.270	161	40	2 x 58W	3,4

1) Factory setting

* The given information is for rough orientation only. In each individual case a lighting calculation is necessary.

Article no.	Type	Quantity of ECG	Connected load [W]	Luminous flux [lm]	Luminous efficacy [lm/W]	Ambient temperature max. [°C]	Substitute for ca. *	Weight [kg] without packing material
-------------	------	-----------------	--------------------	--------------------	--------------------------	-------------------------------	----------------------	--------------------------------------

161PX... HE



highly efficient design for reduced energy consumption

Note:

All 161PX... HE luminaires contain a light source with energy efficiency class A.

16130 0140	161PX 12L42 HE	1	22	4.050	184		2 x 36W	2,8
16130 0141	161PX 12L60 HE	1	35	6.390	183		2 x 58W	2,8
16130 0142	161PX 12L90 HE	1	52	9.500	183		< 3 x 58W	2,8
16130 0143	161PX 12L120 HE	1	69	12.610	183		2 x 80 bzw. 3 x 58W	2,8
16130 0144	161PX 15L34 HE	1	19	3.690	194		1 x 58W	3,4
16130 0145	161PX 15L60 HE	1	32	6.040	189		2 x 58W	3,4
16130 0146	161PX 15L75 HE	1	43	7.980	186		> 2 x 58W	3,4
16130 0147	161PX 15L120 HE	1	70	12.840	183		2 x 80 bzw. 3 x 58W	3,4
16130 0148	161PX 15L150 HE	1	86	15.760	183		4 x 58W	3,4

161PX... HE DIMD



dimmable via DALI interface

Design:

Same as standard version HE, but with DALI-2-ECG and 2 additional clamping points. Dimming range 1-100 %. Compatible with LIMAS Line Light Management System.

16130 0150	161PX 12L42 HE DIMD	1	22	4.050	184		2 x 36W	2,8
16130 0151	161PX 12L60 HE DIMD	1	35	6.390	183		2 x 58W	2,8
16130 0152	161PX 12L90 HE DIMD	1	52	9.500	183		< 3 x 58W	2,8
16130 0153	161PX 12L120 HE DIMD	1	69	12.610	183		2 x 80 bzw. 3 x 58W	2,8
16130 0154	161PX 15L34 HE DIMD	1	19	3.690	194		1 x 58W	3,4
16130 0155	161PX 15L60 HE DIMD	1	32	6.040	189		2 x 58W	3,4
16130 0156	161PX 15L75 HE DIMD	1	43	7.980	186		> 2 x 58W	3,4
16130 0157	161PX 15L120 HE DIMD	1	70	12.840	183		2 x 80 bzw. 3 x 58W	3,4
16130 0158	161PX 15L150 HE DIMD	1	86	15.760	183		4 x 58W	3,4

161PX... ER / HR (RESISTANT)



Note:

See notes in the technical appendix, chapter 4.4.

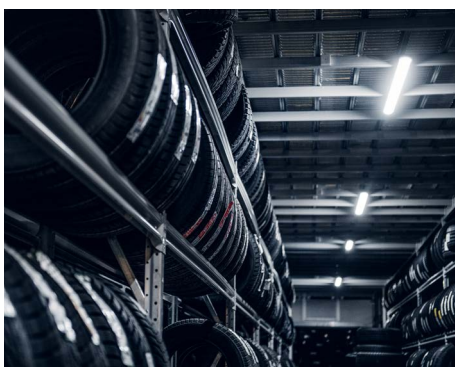

for use in hazardous areas

Applications:

Areas in trade, trade and industry with corrosive atmospheres or craft gases and vapors that can damage the LED up to and including total failure, e.g. chemical industry, galvanizing plants, electroplating plants, foundries, tire production and storage, paper mills, sewage treatment plants, waste incineration plants etc. Advice on request.

Design:

Like the standard version, but with modifications for increased (ER) or high (HR) protection against corrosive atmospheres or harmful gases.

16133 0001	161PX 06L12 ER	1	10	1.340	134	40	1 x 18W	1,7
16133 0004	161PX 06L20 ER	1	16	2.370	148	40	2 x 18W	1,7
16133 0002	161PX 12L22 ER	1	15	2.380	159	40	1 x 36W	2,8
16133 0005	161PX 12L42 ER	1	27	4.430	164	40	2 x 36W	2,8
16133 0007	161PX 12L60 ER	1	39	6.200	159	40	2 x 58W	2,8
16133 0009	161PX 12L120 ER	1	77	12.040	156	35	2 x 80 bzw. 3 x 58W	3,1
16133 0003	161PX 15L34 ER	1	21	3.430	163	40	1 x 58W	3,4
16133 0006	161PX 15L60 ER	1	39	6.440	165	40	2 x 58W	3,4
16133 0008	161PX 15L75 ER	1	49	7.780	159	40	> 2 x 58W	3,4
16133 0010	161PX 15L150 ER	1	93	14.960	161	35	4 x 58W	3,7
16133 0011	161PX 06L12 HR	1	10	1.340	134	40	1 x 18W	2,0
16133 0014	161PX 06L20 HR	1	16	2.370	148	40	2 x 18W	2,0
16133 0012	161PX 12L22 HR	1	15	2.380	159	40	1 x 36W	3,1
16133 0015	161PX 12L42 HR	1	27	4.430	164	40	2 x 36W	3,1
16133 0017	161PX 12L60 HR	1	39	6.200	159	40	2 x 58W	3,1
16133 0019	161PX 12L120 HR	1	77	12.040	156	35	2 x 80 bzw. 3 x 58W	3,8
16133 0013	161PX 15L34 HR	1	21	3.430	163	40	1 x 58W	3,7
16133 0016	161PX 15L60 HR	1	39	6.440	165	40	2 x 58W	3,7
16133 0018	161PX 15L75 HR	1	49	7.780	159	40	> 2 x 58W	3,7
16133 0020	161PX 15L150 HR	1	93	14.960	161	35	4 x 58W	4,3

* The given information is for rough orientation only. In each individual case a lighting calculation is necessary.

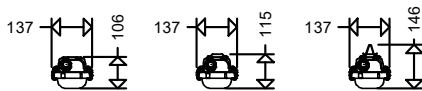
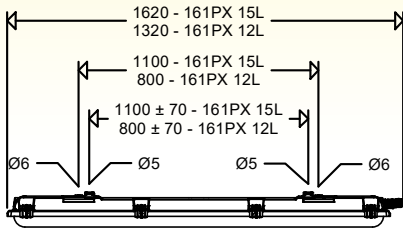
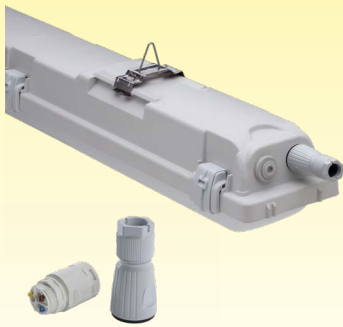

Article no.	Type	Quantity of ECG	Connected load [W]	Luminous flux [lm]	Luminous efficacy [lm/W]	Ambient temperature max. [°C]	Substitute for ca. *	Weight [kg] without packing material
-------------	------	-----------------	--------------------	--------------------	--------------------------	-------------------------------	----------------------	--------------------------------------

161PX... FC



with quick mounting system

Design: Same as standard but, with pre-assembled quick mounting system (FastFix) and quick connection plug (FastConnect), for 3-pole connecting cable up to 2.5 mm² (Ø 7.5 – 12.5 mm)

Advantages of the FastConnect version:

- quick connection plug with pre-assembled strain relief
- installation and electrical connection without opening the light fitting

16130 0192	161PX 12L22 FC	1	15	2.440	163	40	1 x 36W	2,8
16130 0193	161PX 12L42 FC	1	27	4.300	159	40	2 x 36W	2,8
16130 0194	161PX 15L34 FC	1	21	3.520	168	40	1 x 58W	3,4
16130 0195	161PX 15L60 FC	1	39	6.270	161	40	2 x 58W	3,4

* The given information is for rough orientation only. In each individual case a lighting calculation is necessary.

Note:

The FC version can be supplied together with various special versions. The maximum possible ambient temperature is 50 °C.



Dustproof/Waterproof Light Fittings

Accessories / Spare Parts

Article no.	Type		Article no	Type	
spare glasses, PMMA frosted			spare glasses, PC frosted		
16111 9040	ABD 161PX 06		16111 9043	ABD 161PX 06 PC	
16111 9041	ABD 161PX 12		16111 9044	ABD 161PX 12 PC	
16111 9042	ABD 161PX 15		16111 9045	ABD 161PX 15 PC	
spare glasses LM-version					
16111 9046	ABD 161PX 06 LM				
16111 9047	ABD 161PX 12 LM				
16111 9048	ABD 161PX 15 LM				
Fasteners					
90053 9009	KKS FR VE10	plastic safety clips (packing unit 10 pcs.)			
90055 9007	KE/KES G2 VE10	stainless steel clips, incl. 2 safety clips (packing unit 10 pcs.)			
90053 9004	KKS P	1 pair of safety clips (for LED version), plastic			
90055 9006	KES G2 P	1 pair of safety clips (for LED version), stainless steel			
Cable entries/pressure compensation elements					
90063 9000	2511	blanking plug M20			
25610 9000	2561	plastic cable gland M20 x 1,5			
25600 9000	2560	plastic cable gland M25 x 1,5			
90259 9002	DAE20	pressure compensation element M20			
90259 9003	DAE 20/25	adapter gland M20 -> M25 with pressure compensation			
Pipe clamps					
90094 0005	183 RO 112 A P SD	2 pcs., 1 1/2" stainless steel, with support			
90094 0006	183 RO 2 A P SD	2 pcs., 2" stainless steel, with support			
Consider mounting distances when installing the light fittings by pipe clamps to pole outreaches or any brackets.					
Swivel arm mounting					
90303 9000	SWABF 161PX E4 P	1 pair of swivel arm mountings, stainless steel A4			
Infrared remote control for SENS-light fittings					
90295 9000	FB SENSOTEC-MINI	Infrared remote control for 161PX .. SENS			

SWABF 161PX E4 P

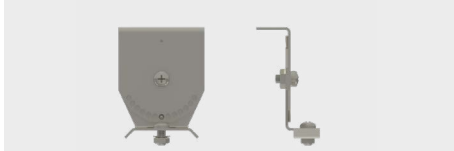

Dustproof/Waterproof LED Light Fitting with Diffuser Series 161/162.. / 161... VARIO

Applications:

Humid, wet and dusty rooms in trade, commerce and industry, multi-storey car parks, underground car parks, cold stores, cold rooms and walk-in cold rooms, covered outdoor areas, etc. (Please enquire in the event of humid, cold ambient conditions with low duty cycles and the presence/ occurrence of chemical substances.)

Design:

Housing: Glass fibre reinforced polyester resin, foamed silicone gasket.

Diffuser: Injection-molded acrylic glass, frosted for glare limitation.

Closure: Three-part captive plastic clips

(KK), incl. 2 safety clips (KKS) to ensure protection against contact.

Reflector: Aluminium, painted, can be suspended or removed and carries the electrical components.

Connection: 3-pole

Cable entries: 2 plugs M20.

Mounting: Closed knock-outs for direct ceiling mounting (to be opened at site). Sealing and pressure disks inside each fitting.

VARIO versions with variable setting of the luminous flux

Applications:

Factories in which, for reasons of maximum standardization and economic storage, only one type of damp-proof luminaire is to be used, which can be used for a wide variety of lighting tasks due to its variably adjustable luminous flux.

Design:

With DIP switch for setting the luminous flux without tools. The luminaire luminous flux can be set to almost any value between 2,410 lm and 5,920 lm. Depending on the set luminous flux, the power consumption of the light fitting and the maximum permissible ambient temperature change.

Technical data:

LED: Linear modules 4,000 K, CRI > 80, service life $L_{90} > 50,000$ h at 25 °C ambient temperature, service life $L_{80} > 70,000$ h and $L_{70} > 100,000$ h at max. ambient temperature

ECG: 220-240 V, 50/60 Hz, overload and short-circuit protection

Ambient temperature: -20 °C (-40 °C for types ...T40) up to ..°C see article table

Options:

- 2,200 K, 2,700 K, 3,000 K, 5,000 K, 6,500 K; light colours (822, 827, 830, 850, 865)
- 1,800 K; light colour (518), amber for insect-friendly lighting in outdoor areas etc.
- high colour rendering index $R_a > 90$
- green LEDs, for lighting potato stores
- coloured LEDs, for signal applications

- through-wiring (DV)
- cable looping at 1 small side
- cable entry M25 x 1,5 mm²
- cover made of polycarbonate (PC), frosted
- stainless steel clips (KE)
- protection class II (SKII)
- vibration-resistant design

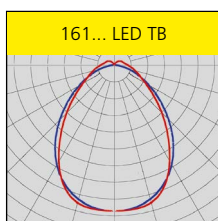
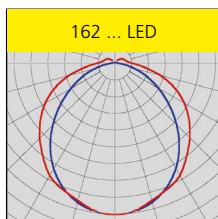
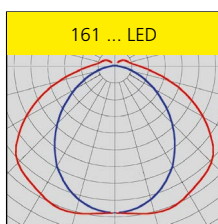

DB standardised by Deutsche Bahn AG

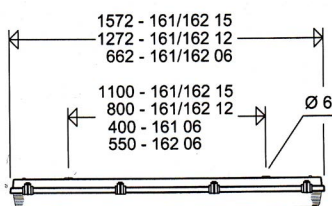

Series 161...

Series 162...

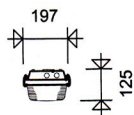
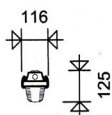

Cable entries for looping the mains cable on one side (loop in/loop out):

Optionally the light fittings can be supplied with 2 cable entries on one small side.

This feature allows an optimal adjustment to all local conditions and it will consequently save the typical quite expensive through wiring system (preparation at additional cost).



Notes:

Maximum energy saving by using types which are optimized for energy consumption.

Product highlights of the VARIO version:

- universally usable due to variable setting of the luminous flux, depending on the requirement
- simple and quick adjustment on-site without tools
- can be changed at any time (e.g. change of use of the premises with new requirements in regard to the level of illumination)
- maximum standardisation and most economical warehousing

General product highlights:

- robust, extremely strong quality light fitting especially suited for rough industrial use
- high-impact resistant housing, excellent chemical and UV-resistance
- diffuser with high mechanical stability, fourfold safety against outer impact
- safety locks to ensure protection against accidental contact
- front in/out wiring (3-pole) possible as standard thanks to 2 entries on one side
- homogeneous illumination by using frosted diffusers
- sustainable, control gear and LED-module replaceable by qualified personnel on-site
- future proof by using standardised LED-modules (Zhaga) and long-term availability of spare parts

Properties, limitations and details for controlling LED-light fittings:

See "Technical Supplement"

All data are correct at the time of printing. Actual technical data can be found under www.schuch.de.

Article no.	Type	Quantity of ECG	Connected load [W]	Luminous flux [lm]	Luminous efficacy [lm/W]	Ambient temperature max. [°C]	Substitute for ca. *	Weight [kg] without packing material
-------------	------	-----------------	--------------------	--------------------	--------------------------	-------------------------------	----------------------	--------------------------------------

161/162... / 161... VARIO



16117 0309	161 06L12	1	10	1.390	139	40	1 x 18W	1,8
16117 0310	161 06L20	1	16	2.370	148	40	2 x 18W	1,8
16117 0301	161 12L22	1	15	2.390	159	40	1 x 36W	2,7
16117 0302	161 12L42	1	27	4.240	157	40	2 x 36W	2,7
16117 0305	161 12L60	1	39	5.920	152	30	2 x 58W	2,7
16117 0303	161 15L34	1	21	3.440	164	40	1 x 58W	3,0
16117 0304	161 15L60	1	39	6.160	158	40	2 x 58W	3,0
16117 0306	161 15L75	1	49	7.440	152	30	> 2 x 58W	3,0
16215 0302	162 12L120	1	78	11.410	146	35	2 x 80 bzw. 3 x 58W	4,3
16215 0303	162 15L150	1	97	14.310	148	35	4 x 58W	4,8
16117 0399	161 12L VARIO	1	15	2.410	160	45	1 x 36W	2,7
			22	3.610 ¹⁾	164	45	1 x 58W	
			29	4.510	156	40	2 x 36W	
			39	5.920	152	35	2 x 58W	

1) Factory setting

161/162... DIMD



dimmable via DALI interface

Design:

Same as standard version, but with DALI-2-ECG and 2 additional clamping points. Dimming range 1-100 %. Compatible with LIMAS Line Light Management System.

16117 0319	161 06L12 DIMD	1	10	1.390	139	40	1 x 18W	1,9
16117 0320	161 06L20 DIMD	1	16	2.370	148	40	2 x 18W	1,9
16117 0311	161 12L22 DIMD	1	15	2.390	159	40	1 x 36W	2,8
16117 0312	161 12L42 DIMD	1	27	4.240	157	40	2 x 36W	2,8
16117 0315	161 12L60 DIMD	1	39	5.920	152	30	2 x 58W	2,8
16117 0313	161 15L34 DIMD	1	21	3.440	164	40	1 x 58W	3,1
16117 0314	161 15L60 DIMD	1	39	6.160	158	40	2 x 58W	3,1
16117 0316	161 15L75 DIMD	1	49	7.440	152	30	> 2 x 58W	3,1
16215 0312	162 12L120 DIMD	1	78	11.410	146	35	2 x 80 bzw. 3 x 58W	4,4
16215 0313	162 15L150 DIMD	1	97	14.310	148	35	4 x 58W	4,9

* The given information is for rough orientation only. In each individual case a lighting calculation is necessary.



Dustproof/Waterproof Light Fittings



161... DIMC/SENS - General information

Applications:

Areas in which the lighting is controlled via motion sensors or door contacts, e.g. storage areas, rack aisles, parking garages etc.

SENS luminaires: are controlled by L' and can generate L'

DIMC luminaires: are controlled by L'

Design:

As standard version but with DALI-2 ECG and additional terminal point, labeled L', optionally with HF sensor (SENS types), see table.

	Clamping point L'	powerless switching	Integrated sensor	Switches off after 30 minutes
161... DIMC	x	x	-	-
161... DIMC-Z30	x	x	-	x
161... SENS	x	x	x	-
161... SENS-Z30	x	x	x	x

Product highlights:

- simple installation and commissioning
- no software or apps required for operation
- only one mains-insulated control cable is required
- "Stand-alone operation" of the SENS luminaires possible, no control phase is required for this
- large energy saving potential through
 - Power consumption reduced by up to 90 % in dimming mode
 - shorter operating time for Z30 versions
- no gateway required
- use of external sensors possible

Technical data:

Control: Any number of DIMC or SENS luminaires can be controlled via the control phase of the SENS luminaires. Switching is powerless. If movement is no longer detected by a SENS luminaire or an external sensor detected (depending on the set hold time), the control phase switches to 0 V and all luminaires connected to the control phase dim to 10 % (factory setting). Please observe the installation instructions in the Technical Supplement.

Programming: the following parameters, among others, can be changed on the LED control gear via the NFC interface: Luminous flux, dimming ramp, switch-off time.

Programming can be done via smartphone and free app.

Detection range of the HF sensor: Depending on the light point height, the detection range is 1-5 m:

- Light point height approx. 2.5 m: Detection area approx. 3 m diameter
- Light point height approx. 5 m: Detection area max. 5 m diameter

Structures such as concrete pillars can restrict the detection area. Materials such as drywall can be penetrated.

Factory settings:

- Standard sensor hold time (X): 5 minutes can be set (see setting options), only for SENS types
- Dimming ramp (Y): 30 seconds, for DIMC and SENS types
- Reduced operation (L' = 0 V): 10 % luminous flux if no activity is detected, for SENS and DIMC types
- Automatic switch-off deactivated (Z), luminaire never switches off.
- For further information, see illustration "Luminous flux profile of the luminaire" for 161... DIMC.

Setting options for SENS luminaires: Via potentiometer on the sensor or optionally via IR remote control (article number 90295 9000):

- Sensitivity of the sensor to avoid unwanted detections in the edge area
- Hold time of the sensor from 10 seconds to 30 minutes, with IR remote control up to 60 minutes

Ambient temperature: -20 °C to see table

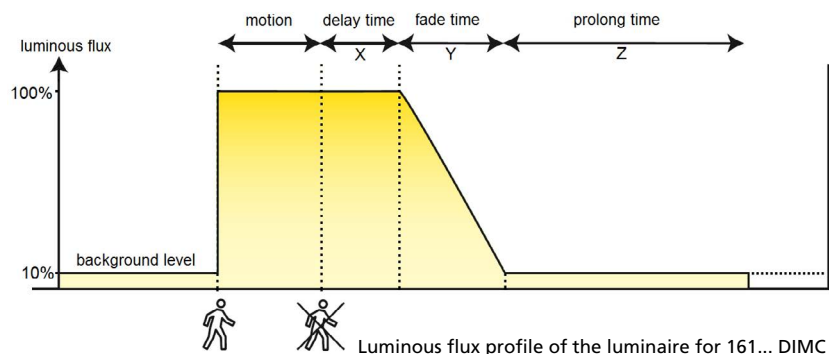

Article no.	Type	Quantity of ECG	Connected load [W]	Luminous flux [lm]	Luminous efficacy [lm/W]	Ambient temperature max. [°C]	Substitute for ca. *	Weight [kg] without packing material
-------------	------	-----------------	--------------------	--------------------	--------------------------	-------------------------------	----------------------	--------------------------------------

161... DIMC



dimnable via Corridor Mode

Factory settings DIMC types:

- Automatic switch-off deactivated, light never switches off.

16117 0420	161 12L22 DIMC	1	15	2.390	159	40	1 x 36W	2,8
16117 0421	161 12L42 DIMC	1	27	4.240	157	40	2 x 36W	2,8
16117 0422	161 15L34 DIMC	1	21	3.440	164	40	1 x 58W	3,1
16117 0423	161 15L60 DIMC	1	39	6.160	158	40	2 x 58W	3,1

161... DIMC-Z30



dimnable via Corridor Mode and automatic switch-off function (30 minutes)

Factory settings DIMC-Z30 types:

- Automatic switch-off activated: 30 minutes 10 % background level, then standby mode (0 %).

16117 0710	161 12L22 DIMC-Z30	1	15	2.390	159	40	1 x 36W	2,8
16117 0711	161 12L42 DIMC-Z30	1	27	4.240	157	40	2 x 36W	2,8
16117 0712	161 15L34 DIMC-Z30	1	21	3.440	164	40	1 x 58W	3,1
16117 0713	161 15L60 DIMC-Z30	1	39	6.160	158	40	2 x 58W	3,1



161... SENS



DIMC version with integrated motion sensor

Design:

As DIMC version, but with integrated motion sensor. As a master luminaire, the luminaire can control all DIMC luminaires connected to it.

Factory settings SENS types:

- Automatic switch-off deactivated, light never switches off.

16117 0697	161 12L22 SENS	1	15	2.390	159	40	1 x 36W	2,9
16117 0698	161 12L42 SENS	1	27	4.240	157	40	2 x 36W	2,9
16117 0699	161 15L34 SENS	1	21	3.440	164	40	1 x 58W	3,2
16117 0700	161 15L60 SENS	1	39	6.160	158	40	2 x 58W	3,2



161... SENS-Z30



DIMC-Z30 version with integrated motion sensor and automatic switch-off function (30 minutes)

Design:

As DIMC-Z30 version, but with integrated motion sensor. As a master luminaire, the luminaire can control all DIMC-Z30 luminaires connected to it.

Factory settings SENS-Z30 types:

- Automatic switch-off activated: 30 minutes 10 % background level, then standby mode (0 %).

16117 0715	161 12L22 SENS-Z30	1	15	2.390	159	40	1 x 36W	2,9
16117 0716	161 12L42 SENS-Z30	1	27	4.240	157	40	2 x 36W	2,9
16117 0718	161 15L34 SENS-Z30	1	21	3.440	164	40	1 x 58W	3,2
16117 0719	161 15L60 SENS-Z30	1	39	6.160	158	40	2 x 58W	3,2

* The given information is for rough orientation only. In each individual case a lighting calculation is necessary.

Article no.	Type	Quantity of ECG	Connected load [W]	Luminous flux [lm]	Luminous efficacy [lm/W]	Ambient temperature max. [°C]	Substitute for ca. *	Weight [kg] without packing material
-------------	------	-----------------	--------------------	--------------------	--------------------------	-------------------------------	----------------------	--------------------------------------

162... TB



with optics for shelf storage aisles and workplace lighting

Applications:

High-bay warehouses, shelf storage aisles, workplace lighting, etc.

Design:

Same as standard versions 162..., but with narrow-wide beam optics (TB).

16215 0601	162 15L120TB	1	78	11.960	153	40	2 x 80 bzw. 3 x 58W	5,4
------------	--------------	---	----	--------	-----	----	---------------------	-----

161... H50



for high ambient temperatures up to +50 °C

Applications:

Power plants, steel plants, machine-oriented areas, areas with high process waste heat, areas close to the ceiling with accumulating heat etc.

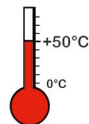

16117 0324	161 06L12 H50	1	10	1.390	139	50	1 x 18W	2,0
16117 0490	161 06L20 H50	1	16	2.370	148	50	2 x 18W	2,0
16117 0321	161 12L22 H50	1	15	2.390	159	50	1 x 36W	2,7
16117 0491	161 12L42 H50	1	27	4.240	157	50	2 x 36W	2,7
16117 0322	161 15L34 H50	1	21	3.440	164	50	1 x 58W	3,0
16117 0492	161 15L60 H50	1	39	6.160	158	50	2 x 58W	3,0
16117 0334	161 06L12 H50 DIMD	1	10	1.390	139	50	1 x 18W	2,0
16117 0493	161 06L20 H50 DIMD	1	16	2.370	148	50	2 x 18W	2,0
16117 0331	161 12L22 H50 DIMD	1	15	2.390	159	50	1 x 36W	2,8
16117 0494	161 12L42 H50 DIMD	1	27	4.240	157	50	2 x 36W	2,8
16117 0332	161 15L34 H50 DIMD	1	21	3.440	164	50	1 x 58W	3,1
16117 0495	161 15L60 H50 DIMD	1	39	6.160	158	50	2 x 58W	3,1



161/162... T40 / H...



for wide temperature ranges from -40 °C up to +70 °C

Applications:

Climatic chambers, material container, test benches in the automotive industry, regions with extreme temperature fluctuations etc.

Design:

As standard version, but:

Diffuser: Injection-molded polycarbonate, frosted for glare limitation.

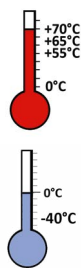

16117 0509	161 06L12 T40 H65	1	9	1.190	132	65	1 x 18W	1,8
16117 0510	161 06L20 T40 H55	1	18	2.620	146	55	2 x 18W	1,8
16117 0501	161 12L22 T40 H65	1	14	2.390	171	65	1 x 36W	2,7
16117 0502	161 12L42 T40 H55	1	27	4.240	157	55	2 x 36W	2,7
16117 0503	161 15L34 T40 H65	1	21	3.440	164	65	1 x 58W	3,0
16117 0504	161 15L60 T40 H55	1	38	6.160	162	55	2 x 58W	3,0
16215 0520	162 12L22 T40 H70	1	15	2.390	159	70	1 x 36W	4,1
16215 0521	162 12L42 T40 H70	1	28	4.840	173	70	2 x 36W	4,1
16215 0501	162 15L34 T40 H70	1	21	3.440	164	70	1 x 58W	4,8
16215 0502	162 15L60 T40 H60	1	39	6.590	169	60	2 x 58W	4,8

* The given information is for rough orientation only. In each individual case a lighting calculation is necessary.

Notes:

The light fitting is **not suitable** for use in extremely exposed locations with high mechanical stress (wind load) or infrequent or occasional use (e.g. maintenance or inspection lighting).

For use in extremely exposed locations with high mechanical loads (wind load), we recommend our series 144 ... AUS or 107 ... G2 (PRIMO XR).

For infrequent or occasional use, we recommend our series 107 ... G2 (PRIMO XR) or the installation of a weather protection cover over the luminaire.

When mounting the light fittings on bracket poles or tubular beams/pipes always use original SCHUCH pipe clamps with support (see accessories).

pole mount with pipe clamps

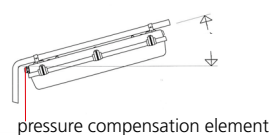
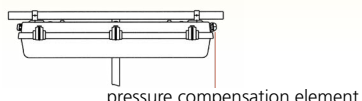

Article no.	Type	Quantity of ECG	Connected load [W]	Luminous flux [lm]	Luminous efficacy [lm/W]	Ambient temperature max. [°C]	Substitute for ca. *	Weight [kg] without packing material
-------------	------	-----------------	--------------------	--------------------	--------------------------	-------------------------------	----------------------	--------------------------------------

161/162... AUS / 161... VARIO AUS



for application in unprotected outdoor areas

Applications:

In protected and unprotected outdoor areas and industrial plants, mounted to walls, ceilings, catwalks and steel structures, pipe brackets, grating, under canopies, bus stops, train stations, subways, construction sites, etc.

Design:

As type 161/162... LED, but:

Diffuser: UV proof

Pressure compensation element: M20

Entries: 1 gland M20 at one small side, pressure compensation element M20 at the other small side.

Mounting:

Ceiling and horizontal wall mount or mounting to outreaches, poles, steel structures, catwalks, etc. by means of pipe clamps. For vertical mounting please consult us.

Advantages of the AUS design:

- glass fibre reinforced polyester housing, durable resistant against UV-radiation and chemical components
- our injection-molded PMMA-covers are extremely UV-resistant and robust (wall thickness 1.9 mm)
- profile gaskets are UV-, ozone-, weather-, chemically resistant and non-aging
- pressure compensation element provides controlled venting and thus protects against condensation
- the fitting can be installed in canopied as well as in entirely open outdoor areas

16117 0350	161 06L12 AUS	1	10	1.390	139	40	1 x 18W	1,8
16117 0358	161 06L20 AUS	1	16	2.370	148	40	2 x 18W	1,8
16117 0351	161 12L22 AUS	1	15	2.390	159	40	1 x 36W	2,7
16117 0352	161 12L42 AUS	1	27	4.240	157	40	2 x 36W	2,7
16117 0355	161 12L60 AUS	1	39	5.920	152	30	2 x 58W	2,7
16117 0353	161 15L34 AUS	1	21	3.440	164	40	1 x 58W	3,0
16117 0354	161 15L60 AUS	1	39	6.160	158	40	2 x 58W	3,0
16117 0356	161 15L75 AUS	1	49	7.440	155	30	> 2 x 58W	3,0
16215 0352	162 12L120 AUS	1	78	11.410	146	35	2 x 80 bzw. 3 x 58W	4,3
16215 0353	162 15L150 AUS	1	97	14.310	148	35	4 x 58W	4,8
16117 0359	161 12L VARIO AUS	1	15	2.410	160	45	1 x 36W	2,7
			22	3.610 ¹⁾	164	45	1 x 58W	
			29	4.510	156	40	2 x 36W	
			39	5.920	152	35	2 x 58W	

1) Factory setting

Dustproof/Waterproof Light Fittings

Notes:

The light fittings in Version IFS are not suitable for cleaning with cleaning agents or disinfectants as well as the cleaning with water-jet units.

Why use PC covers for IFS luminaires?

- splinter-free (in contrast to PMMA)
- risk minimisation, no risk of food contamination (see IFS Standard Food Issue 8, chapter 4.12 risk minimisation)
- extension of the inspection intervals in the risk zones of production

161/162... IFS



for application in food industry areas

Applications:

Food industry or food processing factories, suppliers to the food industry who are falling in the International Featured Standard Food, BRC, HACCP or who are subject to comparably strict requirements.

Design:

Same as type 161/162 .. L..but:

Diffuser: cover Polycarbonate, frosted.

Closure clips: Stainless steel (KE), incl. 2 safety clips (KES) to ensure protection against contact.

16119 0039	161 06L12 IFS	1	10	1.390	139	40	1 x 18W	1,8
16119 0040	161 06L20 IFS	1	16	2.370	148	40	2 x 18W	1,8
16119 0041	161 12L22 IFS	1	15	2.390	159	40	1 x 36W	2,7
16119 0043	161 12L42 IFS	1	27	4.240	157	40	2 x 36W	2,7
16119 0305	161 12L60 IFS	1	39	5.920	152	30	2 x 58W	2,7
16119 0042	161 15L34 IFS	1	21	3.440	164	40	1 x 58W	3,0
16119 0044	161 15L60 IFS	1	39	6.160	158	40	2 x 58W	3,0
16119 0046	161 15L75 IFS	1	49	7.440	155	30	> 2 x 58W	3,0
16219 0302	162 12L120 IFS	1	78	11.410	146	35	2 x 80 bzw. 3 x 58W	4,3
16219 0004	162 15L150 IFS	1	97	14.310	148	35	4 x 58W	4,8

* The given information is for rough orientation only. In each individual case a lighting calculation is necessary.

IFS/BRC/VDMA/HACCP

SCHUCH Light Fittings designed for food and beverage industry applications are in accordance with IFS/BRC/VDMA standards. They can be operated without restrictions in operations that must fulfill the HACCP Concept.

Article no.	Type	Quantity of ECG	Connected load [W]	Luminous flux [lm]	Luminous efficacy [lm/W]	Ambient temperature max. [°C]	Substitute for ca. *	Weight [kg] without packing material
-------------	------	-----------------	--------------------	--------------------	--------------------------	-------------------------------	----------------------	--------------------------------------

Note:
The diffusers of all 161PX... LM luminaires are made from 45 % bio-based plastics.



Note:
The colour rendering index Ra does not incorporate the remaining part (R9) in the light spectrum. The standard light colour 840 has only a minor R9 value. For meat processing factories, we recommend the use of our light fittings with light colour 940 (special version), which emits a bigger amount of red light.

161/162... LM / 161... VARIO LM



for application in food areas

Applications:

Food industry or food processing factories especially in risky areas of the food production or processing, suppliers to the food industry who are falling in the International Featured Standard Food, BRC or HACCP standards or who are subject to comparably strict requirements (e.g. production of food packaging).

Design:

Same as type 161/162... LED but:
Diffuser: Shatterproof, high chemical resistance, elements for glare limitation mounted to the reflector.
Closure clips: Stainless steel (KE), incl. 2 safety clips (KES) to ensure protection against contact.

Advantages of the LM version:

- shatterproof diffuser with very high impact resistance (16 Nm!) even at a high continuous operating temperature
- resistant to grease and aggressive cleaning agents, disinfectants and solvents (we recommend the respective cleaning agents and disinfectants to be tested on their resistance (resistance index on request.))
- Risk minimisation, **no risk of food contamination** (see IFS Standard Food Issue 8, Chapter 4.12 Risk minimisation)
- Extension of the inspection intervals in the risk zones of production

IFS/BRC/VDMA/HACCP

SCHUCH Light Fittings designed for food and beverage industry applications are in accordance with IFS/BRC/VDMA standards. They can be operated without restrictions in operations that must fulfill the HACCP Concept.

16119 0005	161 06L12 LM	1	10	1.390	139	40	1 x 18W	1,8
16119 0006	161 06L20 LM	1	16	2.370	148	40	2 x 18W	1,8
16119 0001	161 12L22 LM	1	15	2.390	159	40	1 x 36W	2,7
16119 0003	161 12L42 LM	1	27	4.240	157	40	2 x 36W	2,7
16119 0018	161 12L60 LM	1	39	5.920	152	30	2 x 58W	2,7
16119 0002	161 15L34 LM	1	21	3.440	164	40	1 x 58W	3,0
16119 0004	161 15L60 LM	1	39	6.160	158	40	2 x 58W	3,0
16119 0019	161 15L75 LM	1	49	7.440	152	30	> 2 x 58W	3,0
16219 0006	162 12L120 LM	1	78	11.410	146	35	2 x 80 bzw. 3 x 58W	4,3
16219 0002	162 15L100 LM	1	67	10.510	157	40	2 x 80W	4,8
16219 0007	162 15L150 LM	1	97	14.310	148	35	4 x 58W	4,8
16119 0399	161 12L VARIO LM	1	15	2.410	160	45	1 x 36W	2,7
			22	3.610 ¹⁾	164	45	1 x 58W	
			29	4.510	156	40	2 x 36W	
			39	5.920	152	35	2 x 58W	

1) Factory setting

161... LM H50



for high ambient temperatures up to +50 °C

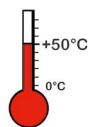

16119 0067	161 06L12 LM H50	1	10	1.390	139	50	1 x 18W	2,0
16119 0050	161 06L20 LM H50	1	16	2.370	148	50	2 x 18W	2,0
16119 0051	161 12L22 LM H50	1	15	2.390	159	50	1 x 36W	2,8
16119 0053	161 12L42 LM H50	1	27	4.240	157	50	2 x 36W	2,8
16119 0052	161 15L34 LM H50	1	21	3.440	164	50	1 x 58W	3,0
16119 0054	161 15L60 LM H50	1	39	6.160	158	50	2 x 58W	3,0

161... LM T40



for ambient temperatures down to -40 °C

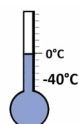

16119 0101	161 12L22 LM T40	1	14	2.390	171	40	1 x 36W	2,7
16119 0103	161 12L42 LM T40	1	27	4.240	157	40	2 x 36W	2,7
16119 0102	161 15L34 LM T40	1	21	3.440	164	40	1 x 58W	3,2
16119 0104	161 15L60 LM T40	1	38	6.160	162	40	2 x 58W	3,2

* The given information is for rough orientation only. In each individual case a lighting calculation is necessary.

Article no.	Type	Quantity of ECG	Connected load [W]	Luminous flux [lm]	Luminous efficacy [lm/W]	Ambient temperature max. [°C]	Substitute for ca. *	Weight [kg] without packing material
-------------	------	-----------------	--------------------	--------------------	--------------------------	-------------------------------	----------------------	--------------------------------------

Note:
See notes in the technical appendix, chapter 4.4.

161... ER / HR (RESISTANT)



for use in hazardous areas

Applications:

Areas in trade, trade and industry with corrosive atmospheres or craft gases and vapors that can damage the LED up to and including total failure. E.g. chemical industry, galvanizing plants, electroplating plants, foundries, tire production and storage, paper mills, sewage treatment plants, waste incineration plants etc. Advice on request.

Design:

Like the standard version, but with modifications for increased (ER) or high (HR) protection against corrosive atmospheres or harmful gases.

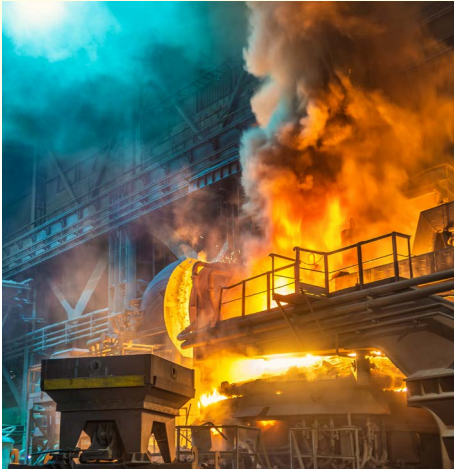

16123 0003	161 12L22 ER	1	15	2.490	166	40	1 x 36W	2,7
16123 0004	161 12L42 ER	1	27	4.410	163	40	2 x 36W	2,7
16123 0005	161 15L34 ER	1	21	3.590	171	40	1 x 58W	3,0
16123 0006	161 15L60 ER	1	39	6.400	164	40	2 x 58W	3,0
16123 0503	161 12L22 HR	1	15	2.490	166	40	1 x 36W	3,0
16123 0504	161 12L42 HR	1	27	4.410	163	40	2 x 36W	3,0
16123 0505	161 15L34 HR	1	21	3.590	171	40	1 x 58W	3,3
16123 0506	161 15L60 HR	1	39	6.400	164	40	2 x 58W	3,3

Dustproof/Waterproof Light Fittings

NEW

162... DB



Applications:

Interior spaces and outdoor facilities in areas away from the tracks, e.g. technical rooms, switchgear, damp rooms etc.

Deutsche Bahn listing:

DB Netze AG
List sheet number 5J10

Design:

Like the standard version, but:

Housing: cover Polycarbonate, frosted
Closure clips: Stainless steel (KE), incl. 2 safety clips (KES) to ensure protection against contact.
Colour rendering: Ra > 90
Protection class: II
Ambient temperature: from -25°C to 45 °C



Photo: Lothar - Beeck

Product highlights of this version:

- Deutsche Bahn listing
- extremely robust
- cost-efficient operation
- environmentally friendly and future-proof



16215 0389	162 06L20KE 940 SKII	1	35	4.520	129	45	2 x 36W	3,9
16215 0388	162 12L42KE 940 SKII	1	18	2.190	122	45	2 x 18W	2,3

* The given information is for rough orientation only. In each individual case a lighting calculation is necessary.

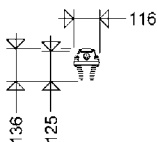
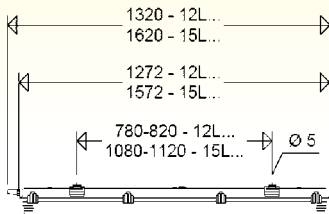
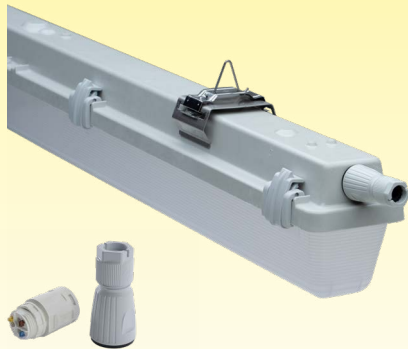

Article no.	Type	Quantity of ECG	Connected load [W]	Luminous flux [lm]	Luminous efficacy [lm/W]	Ambient temperature max. [°C]	Substitute for ca. *	Weight [kg] without packing material
-------------	------	-----------------	--------------------	--------------------	--------------------------	-------------------------------	----------------------	--------------------------------------

161... FF/FC



with FastFix mounting system

Design: Same as standard but, with pre-assembled quick mounting system (FastFix) and quick connection plug (FastConnect), for 3-pole connecting cable up to 2.5 mm² (Ø 7.5 – 12.5 mm)

Advantages of the FastFix/FastConnect version:

- FastFix bracket and quick connection plug pre-assembled
- installation and electrical connection without opening the light fitting
- saves at least 60 % mounting time

16117 0801	161 12L22 FF/FC	1	15	2.390	159	40	1 x 36W	2,7
16117 0802	161 12L42 FF/FC	1	27	4.240	157	40	2 x 36W	2,7
16117 0803	161 15L34 FF/FC	1	21	3.440	164	40	1 x 58W	3,0
16117 0804	161 15L60 FF/FC	1	39	6.160	158	40	2 x 58W	3,0

* The given information is for rough orientation only. In each individual case a lighting calculation is necessary.

Note:

The FC version can be supplied together with various special versions. The maximum possible ambient temperature is 50 °C.

Accessories / Spare Parts

Article no.	Type		Article no	Type	
spare glasses, PMMA frosted			spare glasses, PC frosted		
16111 9035	ABD 161 018 F	for 161 06..	16111 9036	ABD 161 018 F PC	for 161 06..
16111 9031	ABD 161 036 F	for 161 12..	16111 9033	ABD 161 036 F PC	for 161 12..
16111 9032	ABD 161 058 F	for 161 15..	16111 9034	ABD 161 058 F PC	for 161 15..
16211 9035	ABD 162 018 F	for 162 06..	16211 9030	ABD 162 018 F PC	for 162 06..
16211 9031	ABD 162 036 F	for 162 12..	16211 9033	ABD 162 036 F PC	for 162 12..
16211 9032	ABD 162 058 F	for 162 15..	16211 9034	ABD 162 058 F PC	for 162 15..
spare glasses LM-version 161...			spare glasses LM-version 162...		
16111 9017	ABD 161 018 LM	for 161 06..	16211 9018	ABD 162 036 LM	for 162 12..
16111 9018	ABD 161 036 LM	for 161 12..	16211 9019	ABD 162 058 LM	for 162 15..
16111 9019	ABD 161 058 LM	for 161 15..			
Wire guards, powder coated					
90004 0001	SK 120	for 161 06..	90004 0004	SK 220	for 162 06..
90004 0002	SK 140	for 161 12..	90004 0005	SK 240	for 162 12..
90004 0003	SK 165	for 161 15..			
Fasteners					
90053 9008	KK/KKS FR VE10	plastic, incl. 2 safety clips (packing unit 10 pcs.)			
90055 9004	KE/KES VE10	stainless steel, incl. 2 safety clips (packing unit 10 pcs.)			
90053 9004	KKS P	1 pair of safety clips (for LED version), plastic			
90055 9005	KES P	1 pair of safety clips (for LED version), stainless steel			
Cable entries/pressure compensation elements					
90063 9000	2511	blanking plug M20			
25610 9000	2561	plastic cable gland M20 x 1,5			
25600 9000	2560	plastic cable gland M25 x 1,5			
90259 9002	DAE20	pressure compensation element M20			
90259 9003	DAE 20/25	adapter gland M20 -> M25 with pressure compensation			
Pipe clamps					
90093 0002	183 RO 112 A P	2 pcs., 1 1/2" stainless steel, with support			
90094 0002	183 RO 2 A P	2 pcs., 2" stainless steel, with support			
Consider mounting distances when installing the light fittings by pipe clamps to pole outreaches or any brackets.					
Angle brackets, aluminium					
90045 9001	HW 30 P	pair of angle brackets 30°			
90045 9002	HW 45 P	pair of angle brackets 45°			
90045 9004	HW 60 P	pair of angle brackets 60°			
90045 9003	HW 90 P	pair of angle brackets 90°			
Accessories for ceiling mounting					
90049 0002	183 S	hook for chain suspension			
90095 0001	DS 183	stainless steel bracket with bolt M5			
Infrared remote control for SENS-light fittings					
90295 9000	FB SENSOTEC-MINI	Infrared remote control for 161... SENS			

Protective guard

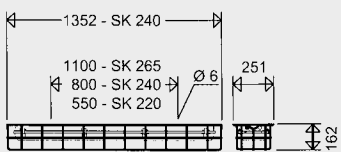
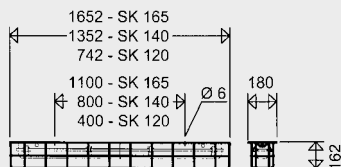

Pipe clamp R1 1/2" - Ø 48,3 mm
R2" - Ø 60,3 mm



Ceiling bracket 183 DS



Extremely robust Dustproof/Waterproof LED-Light Fitting with Central Locking System Series 144 ...

Applications:

In humid, wet and dusty indoor areas and roofed outdoor areas with high mechanical strains as well as areas where any external clips are not wanted or where such clips could create problems. Hard to reach areas and areas with high downtime and maintenance cost when replacing the lamps, Food industry and food processing industry etc. (For damp and cold ambient conditions with low duty cycles and in the case of aggressive atmosphere, please contact us)

Design:

Housing: Glass fibre reinforced polyester resin.

Diffuser: Polycarbonate, clear with internal prisms, hinged.

Gasket: Silicone.

Reflector: Aluminium painted, hinged and removable. Elements for glare limitation mounted to the reflector.

Central locking system: Operated by a hexagonal socket key 13 mm.

Connection: 5-pole terminal

Cable entries: 3 entries

M25 x 1.5 (2 glands and 2 screw plugs).

Looping the mains cable at one end of the housing up to 5 x 2.5 mm² possible.

Mechanical installation:

Mounting accessories see spare parts/accessories.

Technical data:

LED: Linear modules 4,000 K, CRI > 80, service life L90 > 50,000 h at 25 °C ambient temperature, service life L80 > 70,000 h and L70 > 100,000 h at max. ambient temperature

ECG: 220-240 V, 50/60 Hz, overload and short-circuit protection

Ambient temperature: -20 °C up to ..°C see article table

Options:

- 2,200 K, 2,700 K, 3,000 K, 5,000 K, 6,500 K; light colours (822, 827, 830, 850, 865)
- 1,800 K; light colour (518), amber for insect-friendly lighting in outdoor areas etc.
- high colour rendering index Ra > 90
- through-wiring (DV), 5 x 2.5 mm²
- for wide temperature ranges (T40 H..)

- increased resistance (ER), against corrosive atmospheres
- for connection to a central power supply system (ZB)
- dimming function via DALI-2 interface, compatible with LIMAS Line wired Light Management System (DIMD)
- Corridor Mode (DIMC)

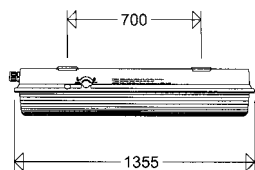
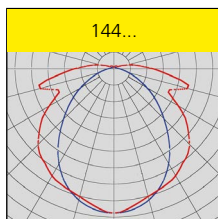

Pipe clamp mounting

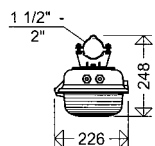

Suspension eyes H8V

Ceiling brackets 15A

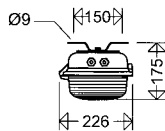
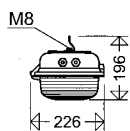

Looping the cable on one side:

All light fittings of series 144... have got 2 cable entries on one small side of the housing for cable looping instead of the through wiring system. This allowing a more economical cable looping at one end instead of the classical through wiring system.

Product highlights:

- extremely sturdy design of high mechanical and chemical resistance for a long term use in rough industrial areas:
 - housing with very high impact resistance
 - polycarbonate diffuser of high-impact resistant
 - robust internal central locking system
 - highly resistant silicone gasket of dimensional stability for permanently safe tightness (IP66)
- front-side in/out wiring (5-pole) possible as standard due to 2 entries on one side
- homogeneous illumination by using elements for glare limitation, no particular light points visible, comfortable perception of light, brilliant glare limitation
- best suitable in the food industry and in the food processing industry especially in risky areas falling under the IFS standards (International Featured Standard Food)
- with adapter gland with pressure compensation prevents condensation water allowing an application in all unprotected outdoor areas (Versions AUS)
- easy to install and maintain:
 - time saving easy mechanical installation by means of eye bolts or ceiling brackets without opening the light fitting
 - time saving central locking system and hinged diffuser
- sustainable, control gear and LED-module replaceable by qualified personnel on-site
- future proof by using standardised LED-modules (Zhaga) and long-term availability of spare parts



Properties, limitations and details for controlling LED-light fittings:

See "Technical Supplement"

All data are correct at the time of printing. Actual technical data can be found under www.schuch.de.

Article No.	Type	Connected load [W]	Luminous flux [lm]	Luminous efficacy [lm/W]	Amb. temp. max. [°C]	Substitute for ca. *	(without packing material)
-------------	------	--------------------	--------------------	--------------------------	----------------------	----------------------	----------------------------

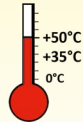

144 ..



14402 0001	144 12L22	14	2.300	164	50	1 x 36W	6,6
14402 0002	144 12L34	22	3.410	155	45	1 x 58W	6,6
14402 0003	144 12L42	29	4.280	148	40	2 x 36W	6,6
14402 0004	144 12L60	44	6.590	150	40	2 x 58W	6,6

Note:

This light fitting is not suitable for rare or occasional operation (e.g. maintenance and inspection lighting).

We recommend our series for use 107 ... G2 (PRIMO XR).

144 .. AUS



for application in unprotected outdoor areas

Applications:

Unprotected outdoor areas, especially in exposed areas with high mechanical stress (wind), catwalks, stairs, steel constructions, pipe brackets, on buildings, storage tank etc.

Design:

As standard type but with adapter gland with pressure compensation prevents condensation water.

Mounting:

Ceiling and horizontal wall mount or mounting to outreaches, poles, steel structures, catwalks, etc. by means of pipe clamps. When mounting the light fittings on bracket poles or tubular beams/pipes always use original SCHUCH pipe clamps with support.

14402 0011	144 12L22 AUS	14	2.300	164	50	1 x 36W	6,6
14402 0012	144 12L34 AUS	22	3.410	155	45	1 x 58W	6,6
14402 0013	144 12L42 AUS	29	4.280	148	40	2 x 36W	6,6
14402 0014	144 12L60 AUS	44	6.590	150	40	2 x 58W	6,6

* The given information is for rough orientation only. In each individual case a lighting calculation is necessary.

Mounting material

Suspension eyes with bolts H8V P



Ceiling brackets 15A P



Pipe clamps RO84...A P



Wall bracket W26/45 P



Further accessories such as carrier rail systems please see EX-installation material in this catalogue.



Accessories / Spare Parts

Article no.	Type	
Spare diffusers for series 144...		
84001 9004	ABD 8404 SIL	cover, diffuser PC clear Silicone, for e840 12 ..., nD844, 144 each from year of manufacture 2013/11
Cable glands/pressure compensation elements		
25600 9000	2560	ex-proof plastic cable gland M25 x 1,5
90118 9000	2538	ex-proof plastic plug M25 x 1,5
90259 9003	DAE20/25	adapter gland M20 -> M25 with pressure compensation
Mounting material		
90001 0002	H8V P	2 suspension eyes with bolts, stainless steel
90000 0002	DS 15A P	2 ceiling brackets, hot galvanized steel
90032 0002	DS 15AV P	2 ceiling brackets, stainless steel
90037 0004	RO84 112 A P	2 pipe clamps 1 1/2", stainless steel, with support
90038 0004	RO84 2 A P	2 pipe clamps 2", stainless steel, with support
26000 0008	WW 26 L P	2 wall mounting angles, sendzimizied
26000 0002	WW 26 30 P	2 wall mounting angles 30°, sendzimizied
26000 0003	WW 26 45 P	2 wall mounting angles 45°, sendzimizied



Dustproof/Waterproof LED Light Fitting with Diffuser Series 163... G2 VARIO / 164... G2

Applications:

In humid, wet and dusty indoor areas of industrial and agricultural premises, for workshops and car parks, cold stores, low temperature stores, cooling chambers and walkable low temperature cabins in hotels, hard to reach areas with high downtime and maintenance costs when replacing the lamps. (For damp and cold ambient conditions with low duty cycles and in the case of aggressive atmosphere, please contact us)

Design:

Housing: Glass fibre reinforced polyester resin, foamed gasket.

Diffuser: PMMA, modified for higher

impact resistance, frosted for glare limitation.

Closure: External plastic clips (KK) incl. 2 safety clips (KKS) to ensure protection against contact.

Reflector: Painted, removable complete with electronic components.

Electrical connection: 3-pole terminal block.

Cable entries: 2 blanking plugs M20. Cable entries open at the front. Variable cable entry pre-pressed on the long side and top side.

Mounting system: 2 holes for ceiling mounting. Sealing and pressure disks for sealing are supplied inside the fitting.

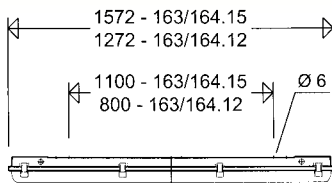

163...

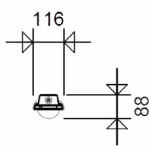

164...

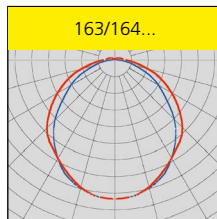
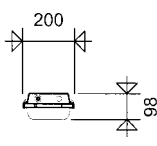

VARIO versions with variable setting of the luminous flux

Applications:

Factories in which, for reasons of maximum standardization and economic storage, only one type of damp-proof luminaire is to be used, which can be used for a wide variety of lighting tasks due to its variably adjustable luminous flux.

Design:

With DIP switch for setting the luminous flux without tools. The luminaire luminous flux can be set to four values. Depending on the set luminous flux, the power consumption of the light fitting and the maximum permissible ambient temperature change.

Technical data:

LED: Linear modules 4,000 K, CRI > 80, service life L_{90} > 50,000 h at 25 °C ambient temperature, service life L_{80} > 70,000 h and L_{70} > 100,000 h at max. ambient temperature

ECG: 220-240 V, 50/60 Hz, overload and short-circuit protection

Ambient temperature: -20 °C (-40 °C for types ...T40) up to ..°C see article table

Options:

- 2,200 K, 2,700 K, 3,000 K, 5,000 K, 6,500 K; light colours (822, 827, 830, 850, 865)
- coloured LEDs, for signal applications
- through-wiring (DV)

- cable looping at 1 small side
- rear cable entry
- cover made of polycarbonate (PC), clear pearled
- stainless steel clips (KE)

Product highlights of the VARIO version:

- universally usable due to variable setting of the luminous flux, depending on the requirement
- simple and quick adjustment on-site without tools
- can be changed at any time (e.g. change of use of the premises with new requirements in regard to the level of illumination)
- maximum standardisation and most economical warehousing

General product highlights:

- quality luminaire with above-average mechanical strength
- safety locks to ensure protection against accidental contact
- variable cable entry thanks to additional entries along and at the top of the housing
- homogeneous illumination by using frosted diffusers, comfortable perception of light and brilliant glare limitation
- sustainable, control gear and LED-module replaceable by qualified personnel on-site
- future proof by using standardised LED-modules (Zhaga) and long-term availability of spare parts

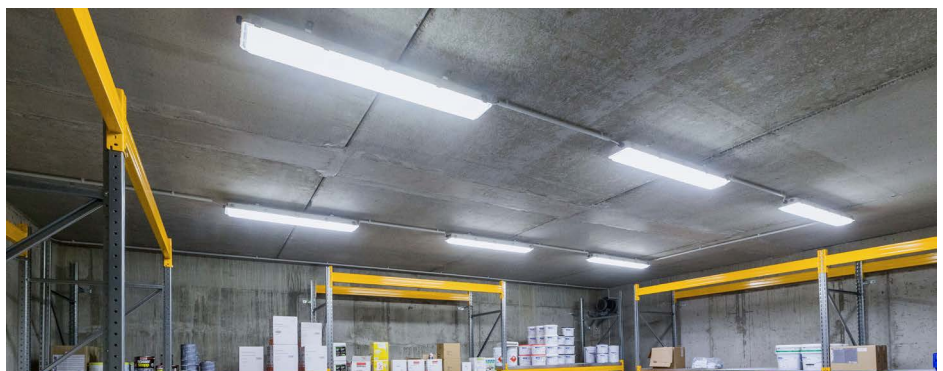

! Properties, limitations and details for controlling LED-light fittings:

■ See "Technical Supplement"

All data are correct at the time of printing. Actual technical data can be found under www.schuch.de.

Article no.	Type	Quantity of ECG	Connected load [W]	Luminous flux [lm]	Luminous efficacy [lm/W]	Ambient temperature max.[°C]	Substitute for ca. *	Weight [kg] without packing material
-------------	------	-----------------	--------------------	--------------------	--------------------------	------------------------------	----------------------	--------------------------------------

163... G2 VARIO / 164... G2



NEW	16302 0010	163 12LG2 VARIO	1	20	3.100	155	40	1 x 36W	2,3
				25	3.870	155	40	1 x 58W	
				29	4.640	160	40	2 x 36W	
				34	5.420 ¹⁾	159	35	2 x 58W	
NEW	16302 0011	163 15LG2 VARIO	1	25	3.880	155	40	1 x 58W	2,8
				30	4.800	160	40	2 x 36W	
				36	5.760	160	40	2 x 58W	
				42	6.650 ¹⁾	158	35	> 2 x 58W	
	16415 0016	164 12L90G2	1	57	8.990	158	40	2 x 80W	3,1
	16415 0017	164 15L120G2	1	78	12.030	154	40	4 x 58W	3,8

1) Factory setting

163/164... G2 DIMD



dimmable via DALI interface

Design:

Same as standard version, but with DALI-2-ECG and 2 additional clamping points. Dimming range 1 -100 %.
Compatible with LIMAS Line Light Management System.

16302 0020	163 12L22G2 DIMD	1	15	2.390	159	40	1 x 36W	2,3
16302 0022	163 12L42G2 DIMD	1	27	4.210	156	40	2 x 36W	2,3
16302 0021	163 15L34G2 DIMD	1	21	3.450	164	40	1 x 58W	2,8
16302 0023	163 15L60G2 DIMD	1	39	6.140	157	40	2 x 58W	2,8
16415 0018	164 12L90G2 DIMD	1	57	8.990	158	40	2 x 80W	3,1
16415 0019	164 15L120G2 DIMD	1	78	12.030	154	40	4 x 58W	3,8

Notes:

The light fittings are not suitable for cleaning with cleaning agents or disinfectants as well as the cleaning with water-jet units.

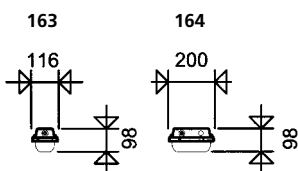

163... VARIO IFS / 164... IFS



for application in food industry areas

Applications:

Food industry or food processing factories, suppliers to the food industry who are falling in the International Featured Standard Food, BRC, HACCP or who are subject to comparably strict requirements.

Design:

Same as type 163/164 .. L.but:

Diffuser: cover Polycarbonate stippled clear.

Closure clips: Stainless steel (KE), incl. 2 safety clips (KES) to ensure protection against contact.

NEW	16319 0010	163 12L VARIO IFS	1	20	3.290	165	40	1 x 36W	2,3
				25	4.100	164	40	1 x 58W	
				29	4.920	170	40	2 x 36W	
				34	5.750 ¹⁾	169	35	2 x 58W	
NEW	16319 0011	163 15L VARIO IFS	1	25	4.110	164	40	1 x 58W	2,8
				30	5.090	170	40	2 x 36W	
				36	6.100	169	40	2 x 58W	
				42	7.050 ¹⁾	168	35	> 2 x 58W	
	16419 0001	164 12L90 IFS	1	57	9.530	167	40	2 x 80W	3,1
	16419 0002	164 15L120 IFS	1	78	12.750	163	40	4 x 58W	3,8

1) Factory setting

* The given information is for rough orientation only. In each individual case a lighting calculation is necessary.

IFS/BRC/VDMA/HACCP

SCHUCH Light Fittings designed for food and beverage industry applications are in accordance with IFS/BRC/VDMA standards. They can be operated without restrictions in operations that must fulfill the HACCP Concept.

Why use PC covers for IFS luminaires?

- splinter-free (in contrast to PMMA)
- risk minimisation, no risk of food contamination (see IFS Standard Food Issue 8, chapter 4.12 risk minimisation)
- extension of the inspection intervals in the risk zones of production



163/164... DIMC/SENS - General information

Applications:

Areas in which the lighting is controlled via motion sensors or door contacts, e.g. storage areas, rack aisles, parking garages etc.

SENS luminaires: are controlled by L' and can generate L'

DIMC luminaires: are controlled by L'

Design:

As standard version but with DALI-2 ECG and additional terminal point, labeled L', optionally with HF sensor (SENS types), see table.

	Clamping point L'	powerless switching	Integrated sensor	Switches off after 30 minutes
163/164... DIMC	x	x	–	–
163/164... DIMC-Z30	x	x	–	x
163... SENS	x	x	x	–
163... SENS-Z30	x	x	x	x

Product highlights:

- simple installation and commissioning
- no software or apps required for operation
- only one mains-insulated control cable is required
- "Stand-alone operation" of the SENS luminaires possible, no control phase is required for this
- large energy saving potential through
 - Power consumption reduced by up to 90 % in dimming mode
 - shorter operating time for Z30 versions
- no gateway required
- use of external sensors possible

Technical data:

Control: Any number of DIMC or SENS luminaires can be controlled via the control phase of the SENS luminaires. Switching is powerless. If movement is no longer detected by a SENS luminaire or an external sensor detected (depending on the set hold time), the control phase switches to 0 V and all luminaires connected to the control phase dim to 10 % (factory setting). Please observe the installation instructions in the Technical Supplement.

Programming: the following parameters, among others, can be changed on the LED control gear via the NFC interface: Luminous flux, dimming ramp, switch-off time. Programming can be done via smartphone and free app.

Detection range of the HF sensor: Depending on the light point height, the detection range is 1-5 m:

- Light point height approx. 2.5 m: Detection area approx. 3 m diameter
- Light point height approx. 5 m: Detection area max. 5 m diameter

Structures such as concrete pillars can restrict the detection area. Materials such as drywall can be penetrated.

Factory settings:

- Standard sensor hold time (X): 5 minutes can be set (see setting options), only for SENS types
- Dimming ramp (Y): 30 seconds, for DIMC and SENS types
- Reduced operation (L' = 0 V): 10 % luminous flux if no activity is detected, for SENS and DIMC types
- Automatic switch-off deactivated (Z), luminaire never switches off.
- For further information, see illustration "Luminous flux profile of the luminaire" for 163/164... DIMC.

Setting options for SENS luminaires: Via potentiometer on the sensor or optionally via IR remote control (article number 90295 9000):

- Sensitivity of the sensor to avoid unwanted detections in the edge area
- Hold time of the sensor from 10 seconds to 30 minutes, with IR remote control up to 60 minutes

Ambient temperature: -20 °C to see table

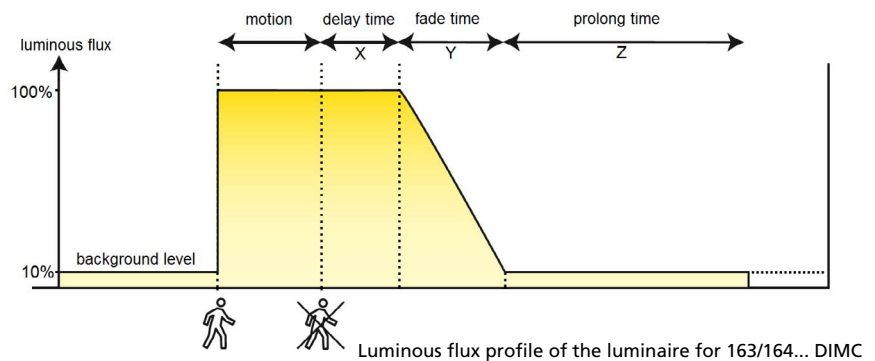

Article no.	Type	Quantity of ECG	Connected load [W]	Luminous flux [lm]	Luminous efficacy [lm/W]	Ambient temperature max. [°C]	Substitute for ca. *	Weight [kg] without packing material
-------------	------	-----------------	--------------------	--------------------	--------------------------	-------------------------------	----------------------	--------------------------------------

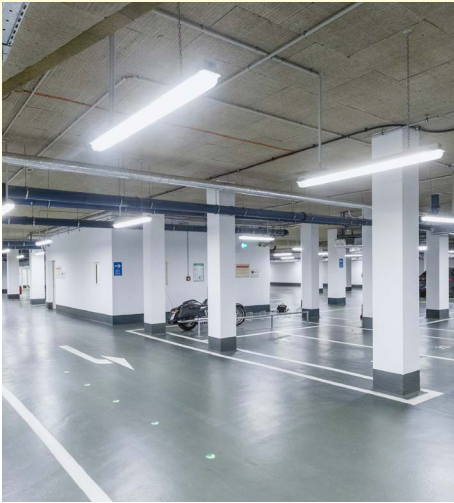

163/164 ... G2 DIMC



dimnable via Corridor Mode

Factory settings DIMC types:

– Automatic switch-off deactivated, light never switches off.

16302 0024	163 12L22G2 DIMC	1	15	2.390	159	40	1 x 36W	2,3
16302 0026	163 12L42G2 DIMC	1	27	4.210	156	40	2 x 36W	2,3
16302 0025	163 15L34G2 DIMC	1	21	3.450	164	40	1 x 58W	2,8
16302 0027	163 15L60G2 DIMC	1	39	6.140	157	40	2 x 58W	2,8
16415 0020	164 12L90G2 DIMC	1	57	8.990	158	40	2 x 80W	3,1
16415 0021	164 15L120G2 DIMC	1	78	12.030	154	40	4 x 58W	3,8



163/164 ... G2 DIMC-Z30

dimnable via Corridor Mode and automatic switch-off function (30 minutes)

Factory settings DIMC-Z30 types:

– Automatic switch-off activated: 30 minutes 10 % background level, then standby mode (0 %).

16302 0120	163 12L22G2 DIMC-Z30	1	15	2.390	159	40	1 x 36W	2,3
16302 0122	163 12L42G2 DIMC-Z30	1	27	4.210	156	40	2 x 36W	2,3
16302 0121	163 15L34G2 DIMC-Z30	1	21	3.450	164	40	1 x 58W	2,8
16302 0123	163 15L60G2 DIMC-Z30	1	39	6.140	157	40	2 x 58W	2,8
16415 0030	164 12L90G2 DIMC-Z30	1	57	8.990	158	40	2 x 80W	3,1
16415 0031	164 15L120G2 DIMC-Z30	1	78	12.030	154	40	4 x 58W	3,8



163... G2 SENS



DIMC version with integrated motion sensor

Design:

As DIMC version, but with integrated motion sensor. As a master luminaire, the luminaire can control all DIMC luminaires connected to it.

Factory settings SENS types:

– Automatic switch-off deactivated, light never switches off.

16302 0030	163 12L22G2 SENS	1	15	2.390	159	40	1 x 36W	2,1
16302 0031	163 12L42G2 SENS	1	27	4.210	156	40	2 x 36W	2,1
16302 0028	163 15L34G2 SENS	1	21	3.450	164	40	1 x 58W	2,5
16302 0029	163 15L60G2 SENS	1	39	6.140	157	40	2 x 58W	2,5



163... G2 SENS-Z30



DIMC-Z30 version with integrated motion sensor and automatic switch-off (30 minutes)

Design:

As DIMC-Z30 version, but with integrated motion sensor. As a master luminaire, the luminaire can control all DIMC-Z30 luminaires connected to it.

Factory settings SENS-Z30 types:

– Automatic switch-off activated: 30 minutes 10 % background level, then standby mode (0 %).

16302 0124	163 12L22G2 SENS-Z30	1	15	2.390	159	40	1 x 36W	2,1
16302 0126	163 12L42G2 SENS-Z30	1	27	4.210	156	40	2 x 36W	2,1
16302 0125	163 15L34G2 SENS-Z30	1	21	3.450	164	40	1 x 58W	2,5
16302 0127	163 15L60G2 SENS-Z30	1	39	6.140	157	40	2 x 58W	2,5

* The given information is for rough orientation only. In each individual case a lighting calculation is necessary.

Article no.	Type	Quantity of ECG	Connected load [W]	Luminous flux [lm]	Luminous efficacy [lm/W]	Ambient temperature max. [°C]	Substitute for ca. *	Weight [kg] without packing material
-------------	------	-----------------	--------------------	--------------------	--------------------------	-------------------------------	----------------------	--------------------------------------

NEW **163... G2 T40/H50**



for wide temperature ranges from -40 °C up to +50°C

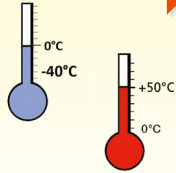

16302 0080	163 12L22G2 T40 H50	1	15	2.390	159	50	1 x 36W	2,4
16302 0082	163 12L42G2 T40 H50	1	27	4.210	156	50	2 x 36W	2,4
16302 0081	163 15L34G2 T40 H50	1	21	3.450	164	50	1 x 58W	2,8
16302 0083	163 15L60G2 T40 H50	1	39	6.140	157	50	2 x 58W	2,8

NEW **163... G2 VARIO SBL**



for use in Swimming pools

Applications:

Swimming pools, indoor pools and chlorinated environments

Attention: Fixing cables, ceiling brackets and wall brackets must be specially designed (on request).

Design:

Modified for high protection against chlorinated atmospheres.

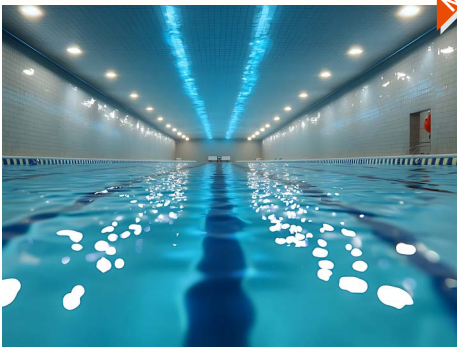

16302 0200	163 12LG2 VARIO SBL	1	19	3.210	169	40	1 x 36W	2,3
			24	3.920	163	40	1 x 58W	
			29	4.620	159	40	2 x 36W	
			35	5.340 ¹⁾	153	35	2 x 58W	
16302 0201	163 15LG2 VARIO SBL	1	24	4.010	167	40	1 x 58W	2,8
			31	4.900	158	40	2 x 36W	
			37	5.770	156	40	2 x 58W	
			43	6.680 ¹⁾	155	35	> 2 x 58W	

1) Factory setting

* The given information is for rough orientation only. In each individual case a lighting calculation is necessary.

Accessories / Spare Parts

Article no.	Type		Article no.	Type	
Spare glasses, PMMA, frosted			Spare glasses, PC, stippled clear		
16711 9001	ABD 163 036 F G2	for 163 12L... G2	16311 9004	ABD 163 036 PC	for 163 12L... IFS
16711 9002	ABD 163 058 F G2	for 163 15L... G2	16311 9005	ABD 163 058 PC	for 163 15L... IFS
16411 9008	ABD 164 036 F G2	for 164 12L... G2	16411 9004	ABD 164 036 PC	for 164 12L... IFS
16411 9009	ABD 164 058 F G2	for 164 15L... G2	16411 9005	ABD 164 058 PC	for 164 15L... IFS
16311 9006	ABD 163 036 F	for 163 12L...			
16311 9007	ABD 163 058 F	for 163 15L...			
16411 9006	ABD 164 036 F	for 164 12L...			
16411 9007	ABD 164 058 F	for 164 15L...			
Fasteners					
90123 9007	163 KK/KKS V08	plastic, incl. 2 safety clips (packing unit 8 pcs.)			
90123 9006	163 KE/KES V08	stainless steel, incl. 2 safety clips (packing unit 8 pcs.)			
90123 9004	163 KKS P	1 pair of safety clips (for LED version), plastic			
90123 9005	163 KES P	1 pair of safety clips (for LED version), stainless steel			
Cable entries					
90063 9000	2511	blinking plug M20			
25610 9000	2561	plastic cable gland M20 x 1,5			
25600 9000	2560	plastic cable gland M25 x 1,5			
Protective guard, powder coated					
90004 0002	SK 140	for 163 12...			
90004 0003	SK 165	for 163 15...			
90004 0005	SK 240	for 164 12...			
Pipe clamps					
90245 0003	163 RO 112A P	1 1/2", stainless steel, with support (pair) for 163...			
90245 0004	163 RO 2A P	2", stainless steel, with support (pair) for 163...			
90245 0005	164 RO 112A P	1 1/2", stainless steel, with support (pair) for 164...			
90245 0006	164 RO 2A P	2", stainless steel, with support (pair) for 164...			
Attention: Observe the fixing distance when mounting on boom with pipe clamps (boom length!)					
Accessories for ceiling mounting					
90049 0002	183 S	swing hook for chain suspension			
90095 0001	DS 183	stainless steel bracket, with screw M5			
Infrared remote control for SENS-light fittings					
90295 9000	FB SENSOTEC-MINI	Infrared remote control for 163 .. SENS			

Protective guard

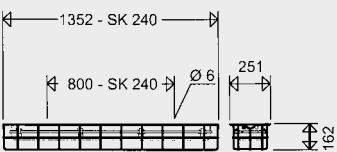
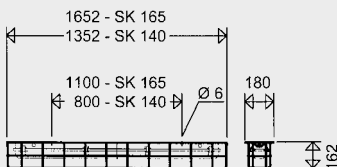

Pipe clamp R1 1/2" - Ø 48,3 mm
R2" - Ø 60,3 mm



Ceiling bracket 183 DS



Dustproof/Waterproof Light Fitting with Diffuser for LED Retrofit-Lamps

Series 161/162... RLED OV 163/164... RLED OV

Application:

In humid, wet and dusty indoor areas of industrial premises, for workshops and car parks, basements etc.

Design:

Without ballast.

Housing: Glass fibre reinforced polyester, foamed gasket.

Diffuser: Injected, clear acrylic glass with internal prisms. (161/162) or stippled clear (163/164).

Closure: Three-part captive plastic clips

Reflector: Sheet Steel, detachable.

Connection: 3-pole terminal block. With built-in fuse for switch-off in case of Lamp fail.

Cable entries: 2 plugs M20.

Mounting: Closed knock-outs for direct ceiling mounting (to be opened at site).

Sealing and pressure disks inside each fitting.

Options:

- through-wiring (DV)
- cable looping at 1 small side
- cover (F), frosted

- cover made of polycarbonate (PC)
- stainless steel clips (KE)

Note:

Not suitable for retrofit lamps that are designed for use in ECG luminaires. Operate IEC 62776 certified lamps only that are released by the manufacturer to operate at mains voltage.

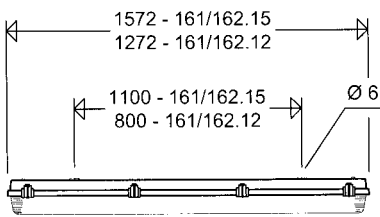

161...

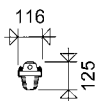

162...

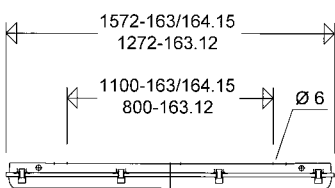
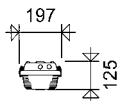

163...

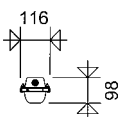

164...

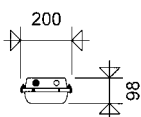

Article no.	Type	Lamps	Length [m]	Weight [kg] without packaging material
-------------	------	-------	------------	--

161/162... RLED OV



16117 0106	161 1/12 RLED OV	1 x LED-Retrofit	1,2	3,9
16117 0107	161 1/15 RLED OV	1 x LED-Retrofit	1,5	3,0
16215 0106	162 2/12 RLED OV	2 x LED-Retrofit	1,2	3,9
16215 0107	162 2/15 RLED OV	2 x LED-Retrofit	1,5	4,7

163/164... RLED OV



16302 0208	163 1/12 RLED OV	1 x LED-Retrofit	1,2	1,8
16302 0209	163 1/15 RLED OV	1 x LED-Retrofit	1,5	2,2
16415 0209	164 2/15 RLED OV	2 x LED-Retrofit	1,5	3,5

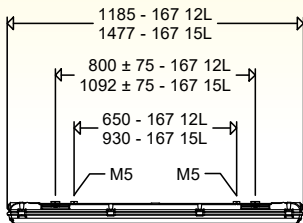
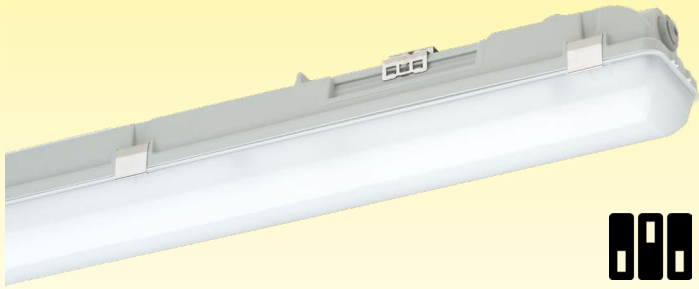

LUXANO 2

Dustproof/Waterproof LED Light Fitting with Diffuser Series 167 ... G2 / 167... G2 VARIO

Applications:

In humid, wet and dusty indoor areas of industrial and agricultural premises, for workshops and car parks etc.

(For damp and cold ambient conditions with low duty cycles and in the case of aggressive atmosphere, please contact us)

Applications:

Housing: Glass fibre reinforced polyester resin, foamed polyurethane gasket.

Diffuser: PMMA, frosted for glare limitation.

Closures: stainless steel, in order to ensure the protection against contact.

The light fitting can be opened with a tool only.

Reflector: Painted, removable, completed with electronic components.

Electrical connection: 3-pole terminal block.

Cable entries: 2 blanking plugs M20.

Cable entries open at the front. Variable cable entry pre-pressed on the long side and top side.

Mounting system: 2 retaining clips made of stainless steel, 2 bracket for chain suspension (part of the delivery)

VARIO versions with variable setting of the luminous flux

Applications:

Factories in which, for reasons of maximum standardization and economic storage, only one type of damp-proof luminaire is to be used, which can be used for a wide variety of lighting tasks due to its variably adjustable luminous flux.

Design:

With DIP switch for setting the luminous flux without tools. The luminaire luminous flux can be set to four values. Depending on the set luminous flux, the power consumption of the light fitting and the maximum permissible ambient temperature change.

Technical data:

LED: Linear modules 4,000 K, CRI > 80, service life $L_{80} > 50,000$ h and $L_{70} > 100,000$ h at max. ambient temperature

Type HE CS / HE VARIO / L100 / LW / ER DIMD / T40/50

LED: Linear modules 4,000 K, CRI > 80, service life $L_{90} > 50,000$ h at 25 °C ambient temperature, service life $L_{80} > 70,000$ h and $L_{70} > 100,000$ h at max. ambient temperature

ECCG: 220-240 V, 50/60 Hz

Ambient temperature: -20 °C up to see article table

Options:

- 2,200 K, 2,700 K, 3,000 K, 5,000 K, 6,500 K; light colours (822, 827, 830, 850, 865)
- 1,800 K; light colour (518), amber for insect-friendly lighting in outdoor areas etc.
- coloured LEDs, for signal applications
- through-wiring (DV)
- cable looping at 1 small side
- rear cable entry
- protection class II (SKII)

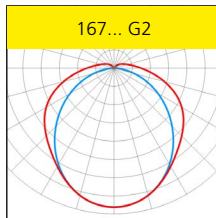

Product highlights of the VARIO version:

- universally usable due to variable setting of the luminous flux, depending on the requirement
- simple and quick adjustment on-site without tools
- can be changed at any time (e.g. change of use of the premises with new requirements in regard to the level of illumination)
- maximum standardisation and most economical warehousing

General product highlights:

- quality luminaire with high-end components from renowned manufacturers
- stainless steel locking fasteners
- safety locks to ensure protection against accidental contact
- FastFix quick mounting system, with retaining clips made of stainless steel for variable mounting distances, without opening the fitting
- variable cable entries, closed knock-outs on the short and long sides, and on the backside
- homogeneous illumination by using frosted diffusers, no individual light spots visible, comfortable perception of light and excellent glare limitation
- high flexibility thanks to a wide range of modifications
- sustainable, control gear and LED-module replaceable by qualified personnel on-site

Properties, limitations and details for controlling LED-light fittings:

See "Technical Supplement"

All data are correct at the time of printing. Actual technical data can be found under www.schuch.de.

Notes:

In case of horizontal installation, the light fitting must be fixed directly with screws (washer and pressure disk are included) or it must be mounted with reinforced retaining clips (see accessories)!

Article no.	Type	Quantity of ECG	Connected load [W]	Luminous flux [lm]	Luminous efficacy [lm/W]	Tmax [°C]	Substitute for *	Weight [kg] without packing material
-------------	------	-----------------	--------------------	--------------------	--------------------------	-----------	------------------	--------------------------------------

167... G2 VARIO

★	16700 0020	167 12LG2 VARIO	1	18	2.700	150	35	> 1 x 36W	1,7
				21	3.100	148	35	< 1 x 58W	
				26	3.800	146	35	> 1 x 58W	
				30	4.300 ¹⁾	143	35	2 x 36W	
★	16700 0021	167 15LG2 VARIO	1	25	3.800	152	35	> 1 x 58W	1,9
				29	4.400	152	35	2 x 36W	
				36	5.400	150	35	< 2 x 58W	
				43	6.200 ¹⁾	144	35	2 x 58W	
NEW	16700 0022	167 15L100 G2 VARIO	1	18	3.030	168	50	< 1x 58W	2,0
				31	5.450	176	40	< 2x 58W	
				40	6.940 ¹⁾	174	40	> 2x 58W	
				53	8.780	166	35	< 3x 58W	
				62	10.110	163	35	3x 58W	
				70	11.210	160	35	< 4x 58W	

★ BestSelect – a selection of tried-and-tested SCHUCH luminaires for your everyday needs. More at: www.schuch.de/BestSelect

167... G2 HE VARIO**highly efficient design for reduced energy consumption**

The luminaire luminous flux can be set to four values. Depending on the set luminous flux, the power consumption of the light fitting and the maximum permissible ambient temperature change.

16704 0001	167 12LG2 HE VARIO	1	19	3.250 ¹⁾	171	40	1 x 58W	1,7
			24	4.000	167	40	> 1 x 58W	
			29	4.770	164	40	2 x 36W	
			34	5.540	163	35	> 2 x 36W	
16704 0002	167 15LG2 HE VARIO	1	24	4.070	170	40	> 1 x 58W	2,0
			30	5.000	167	40	2 x 36W	
			36	5.960 ¹⁾	166	40	2 x 58W	
			43	6.930	161	35	> 2 x 58W	

Notes:

The light fitting is **not suitable** for use in extremely exposed locations with high mechanical stress (wind load) or infrequent or occasional use (e.g. maintenance or inspection lighting).

For use in extremely exposed locations with high mechanical loads (wind load), we recommend our series 144 ... AUS or 107 ... G2 (PRIMO XR).

For infrequent or occasional use, we recommend our series 107 ... G2 (PRIMO XR) or the installation of a weather protection cover over the luminaire.

When mounting the light fittings on bracket poles or tubular beams/pipes always use original SCHUCH pipe clamps with support (see accessories).

167... G2 VARIO AUS**for application in unprotected outdoor areas****Applications:**

In protected and unprotected outdoor areas, mounted to walls, ceilings, catwalks, under canopies, bus stops, train stations, subways, construction sites, etc.

Design:

As type 167... G2, but:

Diffuser: UV proof

Gasket: silicone

Pressure compensation element: M20

Entries: 1 gland M20 at one small side, pressure compensation element M20 at the other small side.

Mounting system: 2 reinforced retaining clips (also suitable for horizontal wall mounting) made of stainless steel (part of the delivery)

16701 0030	167 12LG2 VARIO AUS	1	18	2.700	150	35	> 1 x 36W	1,7	
			21	3.100	148	35	< 1 x 58W		
			26	3.800	146	35	> 1 x 58W		
			30	4.300 ¹⁾	143	35	2 x 36W		
16701 0031	167 15LG2 VARIO AUS	1	25	3.800	152	35	> 1 x 58W	1,9	
			29	4.400	152	35	2 x 36W		
			36	5.400	150	35	< 2 x 58W		
			43	6.200 ¹⁾	144	35	2 x 58W		
NEW	16701 0032	167 15L100G2 VARIO AUS	1	18	3.030	168	50	< 1x 58W	2,0
				31	5.450	176	40	< 2x 58W	
				40	6.940 ¹⁾	174	40	> 2x 58W	
				53	8.780	166	35	< 3x 58W	
				62	10.110	163	35	3x 58W	
				70	11.210	160	35	< 4x 58W	

1) Factory setting

* The given information is for rough orientation only. In each individual case a lighting calculation is necessary.

Article no.	Type	Quantity of ECG	Connected load [W]	Luminous flux [lm]	Luminous efficacy [lm/W]	Tmax [°C]	Substitute for *	Weight [kg] without packing material
-------------	------	-----------------	--------------------	--------------------	--------------------------	-----------	------------------	--------------------------------------

167... G2 VARIO IFS



Notes:

The light fittings in Version IFS are not suitable for cleaning with cleaning agents or disinfectants as well as the cleaning with water-jet units.

for application in food industry areas

Applications:

Food industry or food processing factories, suppliers to the food industry who are falling in the International Featured Standard Food, BRC, HACCP or who are subject to comparably strict requirements.

Design:

Same as type 167... G2 but:
Diffuser: cover Polycarbonate, frosted.

16719 0020	167 12LG2 VARIO IFS	1	18	2.700	150	35	> 1 x 36W	1,7
			21	3.100	148	35	< 1 x 58W	
			26	3.800	146	35	> 1 x 58W	
			30	4.300 ¹⁾	143	35	2 x 36W	
16719 0021	167 15LG2 VARIO IFS	1	25	3.800	152	35	> 1 x 58W	1,9
			29	4.400	152	35	2 x 36W	
			36	5.400	150	35	< 2 x 58W	
			43	6.200 ¹⁾	144	35	2 x 58W	
16719 0022	167 15L100G2 VARIO IFS	1	18	3.030	168	50	< 1x 58W	2,0
			31	5.450	176	40	< 2x 58W	
			40	6.940 ¹⁾	174	40	> 2x 58W	
			53	8.780	166	35	< 3x 58W	
			62	10.110	163	35	3x 58W	
			70	11.210	160	35	< 4x 58W	

Why use PC covers for IFS luminaires?

- splinter-free (in contrast to PMMA)
- risk minimisation, no risk of food contamination (see IFS Standard Food Issue 8, chapter 4.12 risk minimisation)
- extension of the inspection intervals in the risk zones of production



167... G2 VARIO FC



with quick mounting system

Design: Same as standard but, with pre-assembled quick mounting system (FastFix) and quick connection plug (FastConnect), for 3-pole connecting cable up to 2.5 mm² (Ø 8.3 – 11.5 mm)

Advantages of the FastConnect version:

- quick connection plug with pre-assembled strain relief
- installation and electrical connection without opening the light fitting
- Time saving during luminaire installation ≥ 50 %

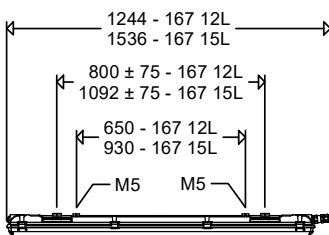

16700 0060	167 12LG2 VARIO FC	1	18	2.700	150	35	> 1 x 36W	1,7
			21	3.100	148	35	< 1 x 58W	
			26	3.800	146	35	> 1 x 58W	
			30	4.300 ¹⁾	143	35	2 x 36W	
16700 0061	167 15LG2 VARIO FC	1	25	3.800	152	35	> 1 x 58W	1,9
			29	4.400	152	35	2 x 36W	
			36	5.400	150	35	< 2 x 58W	
			43	6.200 ¹⁾	144	35	2 x 58W	

1) Factory setting

* The given information is for rough orientation only. In each individual case a lighting calculation is necessary.

Note:

The FC version can be supplied together with various special versions. The maximum possible ambient temperature is 50 °C.



167... G2 DIMC/SENS - General information

Applications:

Areas in which the lighting is controlled via motion sensors or door contacts, e.g. storage areas, rack aisles, parking garages etc.

SENS luminaires: are controlled by L' and can generate L'

DIMC luminaires: are controlled by L'

Design:

As standard version but with DALI-2 ECG and additional terminal point, labeled L', optionally with HF sensor (SENS types), see table.

	Clamping point L'	powerless switching	Integrated sensor	Switches off after 30 minutes
167... G2 DIMC	x	x	–	–
167... G2 DIMC-Z30	x	x	–	x
167... G2 SENS	x	x	x	-
167... G2 SENS-Z30	x	x	x	x

Product highlights:

- simple installation and commissioning
- no software or apps required for operation
- only one mains-insulated control cable is required
- "Stand-alone operation" of the SENS luminaires possible, no control phase is required for this
- large energy saving potential through
 - Power consumption reduced by up to 90 % in dimming mode
 - shorter operating time for Z30 versions
- no gateway required
- use of external sensors possible

Technical data:

Control: Any number of DIMC or SENS luminaires can be controlled via the control phase of the SENS luminaires. Switching is powerless. If movement is no longer detected by a SENS luminaire or an external sensor detected (depending on the set hold time), the control phase switches to 0 V and all luminaires connected to the control phase dim to 10 % (factory setting). Please observe the installation instructions in the Technical Supplement.

Programming: the following parameters, among others, can be changed on the LED control gear via the NFC interface: Luminous flux, dimming ramp, switch-off time.

Programming can be done via smartphone and free app.

Detection range of the HF sensor: Depending on the light point height, the detection range up to 10 m. Structures such as concrete pillars can restrict the detection area. Materials such as drywall can be penetrated.

Factory settings:

- Standard sensor hold time (X): 5 minutes can be set (see setting options), only for SENS types
- Dimming ramp (Y): 30 seconds, for DIMC and SENS types
- Reduced operation (L' = 0 V): 10 % luminous flux if no activity is detected, for SENS and DIMC types
- Automatic switch-off deactivated (Z), luminaire never switches off.
- For further information, see illustration "Luminous flux profile of the luminaire" for 167... DIMC.

Setting options for SENS luminaires: Via potentiometer on the sensor or optionally via IR remote control (article number 90295 9000):

- Sensitivity of the sensor to avoid unwanted detections in the edge area
- Hold time of the sensor from 10 seconds to 30 minutes, with IR remote control up to 60 minutes

Ambient temperature: -20 °C to see table

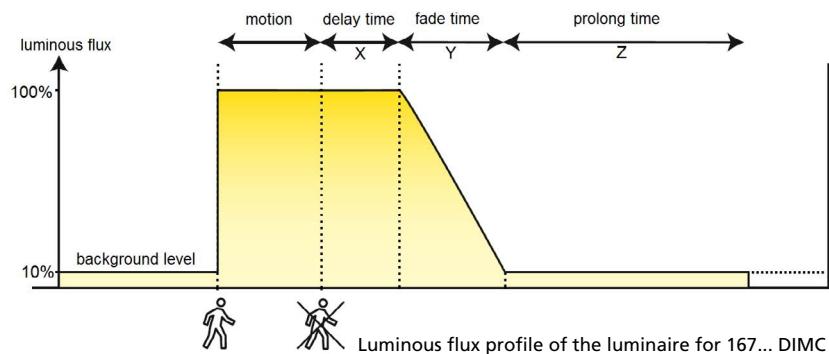

Article no.	Type	Quantity of ECG	Connected load [W]	Luminous flux [lm]	Luminous efficacy [lm/W]	Tmax [°C]	Substitute for *	Weight [kg] without packing material
-------------	------	-----------------	--------------------	--------------------	--------------------------	-----------	------------------	--------------------------------------

167... G2 DIMC



with Corridor Mode

Factory settings DIMC types:

- Automatic switch-off deactivated, light never switches off.

16700 0037	167 12L42G2 DIMC	1	30	4.100	137	35	2 x 36W	1,7
16700 0036	167 15L34G2 DIMC	1	28	3.850	138	35	1 x 58W	2,0
16700 0038	167 15L60G2 DIMC	1	43	6.000	140	35	2 x 58W	2,0
16700 0039	167 15L100G2 DIMC	1	70	11.210	160	35	3 x 58W	2,2

167... G2 DIMC-Z30



dimmable via Corridor Mode and automatic switch-off function (30 minutes)

Factory settings different from DIMC-Z30 types:

- Automatic switch-off activated: 30 minutes 10 % background level, then standby mode (0 %).

16700 0067	167 12L42G2 DIMC-Z30	1	30	4.100	137	35	2 x 36W	1,7
16700 0066	167 15L34G2 DIMC-Z30	1	28	3.850	138	35	1 x 58W	2,0
16700 0068	167 15L60G2 DIMC-Z30	1	43	6.000	140	35	2 x 58W	2,0
16700 0089	167 15L100G2 DIMC-Z30	1	70	11.210	160	35	3 x 58W	2,2

167... G2 SENS



DIMC version with integrated motion sensor

Design:

As DIMC version, but with integrated motion sensor. As a master luminaire, the luminaire can control all DIMC luminaires connected to it.

Factory settings SENS types:

- Automatic switch-off deactivated, light never switches off.

16700 0050	167 12L42G2 SENS	1	23	3.840	167	40	2 x 36W	1,7
16700 0051	167 15L34G2 SENS	1	21	3.660	174	40	1 x 58W	2,0
16700 0052	167 15L60G2 SENS	1	36	5.810	166	40	2 x 58W	2,0

167... G2 SENS-Z30



DIMC-Z30 version with integrated motion sensor and switch-off function (30 minutes)

Design:

As DIMC-Z30 version, but with integrated motion sensor. As a master luminaire, the luminaire can control all DIMC-Z30 luminaires connected to it.

Factory settings SENS-Z30 types:

- Automatic switch-off activated: 30 minutes 10 % background level, then standby mode (0 %).

16700 0055	167 12L42G2 SENS-Z30	1	23	3.840	167	40	2 x 36W	1,7
16700 0056	167 15L34G2 SENS-Z30	1	21	3.660	174	40	1 x 58W	2,0
16700 0057	167 15L60G2 SENS-Z30	1	36	5.810	166	40	2 x 58W	2,0

167... G2 DIMD



dimmable via DALI interface

Design:

Same as standard version, but with DALI-2-ECG and 2 additional clamping points. Dimming range 1 -100 %. Compatible with LIMAS Line Light Management System.

16700 0033	167 12L42G2 DIMD	1	30	4.100	137	35	2 x 36W	1,7
16700 0032	167 15L34G2 DIMD	1	28	3.850	138	35	1 x 58W	2,0
16700 0034	167 15L60G2 DIMD	1	43	6.000	140	35	2 x 58W	2,0
16700 0035	167 15L100G2 DIMD	1	70	11.210	160	35	3 x 58W	2,2

* The given information is for rough orientation only. In each individual case a lighting calculation is necessary.



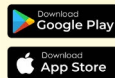

Article no.	Type	Quantity of ECG	Connected load [W]	Luminous flux [lm]	Luminous efficacy [lm/W]	Tmax [°C]	Substitute for *	Weight [kg] without packing material
-------------	------	-----------------	--------------------	--------------------	--------------------------	-----------	------------------	--------------------------------------

167... G2 HE CS



with smart LIMAS Air light control via radio

Applications:

Areas where no DALI lines are available or planned, but the luminaires are to be controlled intelligently.

Design:

As standard version, but with CASAMBI®-enabled control gear for smart lighting control.

Explanations on smart light control as well as further system accessories (sensors / switches / pushbuttons etc.) can be found in the catalog section „Light Management - LIMAS Air“.

Product highlights:

- each individual luminaire separately controllable
- compatible with all LIMAS Air system accessories
- convenient configuration and control via radio using free smartphone app (Android and iOS)
- no gateway and no internet connection required
- extensive portfolio of sensors and actuators
- high-efficiency design (HE) for reduced energy consumption
- significant reduction of operating costs and CO₂ reduction

16700 0090	167 12L42G2 HE CS	1	27	4.380	162	40	2 x 36W	1,7
16700 0091	167 15L60G2 HE CS	1	39	6.460	166	40	2 x 58W	2,0

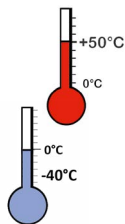

167... G2 T40 / H50



for wide temperature ranges from -40 °C up to +50 °C

16700 0083	167 12L42G2 T40 H50	1	27	4.380	162	50	2 x 36W	1,7
16700 0082	167 15L34G2 T40 H50	1	24	4.070	170	50	1 x 58W	2,0
16700 0084	167 15L60G2 T40 H50	1	39	6.460	166	50	2 x 58W	2,0



167... G2 HL



for particularly humid rooms

Applications:

Agricultural storage (vegetables, potatoes, etc.), wine cellars, technical areas in drinking water supply systems, areas with very high humidity and predominantly short operating times.

Design:

As standard version 167...G2, but with corrosion-protected components.

Seal: Silicone

Cable entry: 1 M20 screw connection on one end, 1 M20 screw plug on the other end.

Mounting: 2 reinforced retaining clips (also suitable for (also suitable for horizontal wall mounting) made of stainless steel, 2 brackets for chain suspension (included in scope of delivery).

Note:

Select series PRIMO XR for condensation on ceilings/walls.

Product highlights:

- specially designed for high humidity with predominantly short operating times
- corrosion-proof encapsulated ECG
- highly resistant LED modules with additional protective coating
- extremely efficient
- low-glare light due to satinised cover tray

16706 0003	167 12L42G2 HL	1	23	4.000	174	35	1 x 58W	1,7
16706 0004	167 15L60G2 HL	1	37	6.140	166	35	2 x 58W	2,0

* The given information is for rough orientation only. In each individual case a lighting calculation is necessary.



Article no.	Type	Quantity of ECG	Connected load [W]	Luminous flux [lm]	Luminous efficacy [lm/W]	Tmax [°C]	Substitute for *	Weight [kg] without packing material
-------------	------	-----------------	--------------------	--------------------	--------------------------	-----------	------------------	--------------------------------------



167... G2 LW



for application in stables and agriculture farming

Applications:

Pigsties with increased ammonia exposure, dairy cattle, cattle and horse barns.
Damp, wet and dusty rooms in agricultural premises as well as rooms with increased fire risk due to combustible dusts, e.g. barns, straw and feed storage.

Design:

Same as type 167... G2 but with corrosion-proof and highly ammonia-resistant components.

Gasket: silicone

Cable entries: 1 gland M20 at one small side, blanking plug M20 at the other small side.

Mounting system: 2 reinforced retaining clips (also suitable for horizontal wall mounting), made of stainless steel, 2 brackets for chain suspension (part of the delivery).

Product highlights:

- permanently ammonia-resistant design
- corrosion-proof encapsulated electronic ballast
- highly resistant LED Modules with additional protective coating
- extremely efficient up to 174 lm/W
- none-flickering light to avoid stress and to ensure animal welfare
- DLG (German Agricultural Society) exam



16702 0013	167 12L42G2 LW	1	23	4.000	174	35	1 x 58W	1,7
16702 0014	167 15L60G2 LW	1	37	6.140	166	35	2 x 58W	2,0

Note:

The light fitting 167 ... G2 ER DIMD is not suitable for use in pig stalls! We recommend using our 107... PRIMO XR LW DIMD series.



167... G2 ER DIMD



for application in stables and agriculture farming

Applications:

In poultry farming in accordance with the German Animal Welfare (TierSCHNutzTV), dairy cattle, cattle and horse stables.

Damp, wet and dusty rooms in agricultural premises as well as rooms with increased fire risk due to combustible dusts, e.g. barns, straw and feed stores.

Design:

Like version 167 ... G2 LW but with DALI-2-ECG (not encapsulated in a corrosion-proof manner) and 2 additional terminal points. Dimming range 1-100 %.

Compatible with LIMAS Line Light Management System.

16702 0023	167 12L42G2 ER DIMD	1	24	4.170	174	35	2 x 36W	1,7
16702 0024	167 15L60G2 ER DIMD	1	37	6.140	166	35	2 x 58W	2,0

* The given information is for rough orientation only. In each individual case a lighting calculation is necessary.

Gas-tight encapsulated light sensor

Specially developed for use in environments contaminated with harmful gases, our new LL XR DS4 light sensor is ideal for animal houses contaminated with ammonia. Robustly constructed and gas-tight encapsulated, it offers outstanding durability and reliability in these demanding areas.

See catalog chapter Light management systems / LIMAS Line.

Accessories / Spare Parts

Article no.	Type	
spare glasses, PMMA, frosted		
16711 9003	ABD 167 12 G2	cover, frosted PMMA diffuser, for 167 12 ... G2
16711 9004	ABD 167 15 G2	cover, frosted PMMA diffuser, for 167 15 ... G2
16711 9005	ABD 167 12 G2 PC	cover, frosted PC diffuser, for 167 12 ... G2
16711 9006	ABD 167 15 G2 PC	cover, frosted PC diffuser, for 167 15... G2
Fasteners		
90123 9008	167G2 KE V10	stainless steel (packing unit 10)
Cable entries/pressure compensation elements		
90063 9000	2511	blanking plug M20
25610 9000	2561	plastic cable gland M20 x 1,5
90259 9002	DAE20	pressure compensation element M20 for ... AUS
Accessories		
90049 0004	HK 167 G2 P	1 pair of retaining clips (stainless steel) reinforced for variable mounting
Infrared remote control for SENS-light fittings		
90295 9000	FB SENSOTEC-MINI	Infrared remote control for 167... G2 SENS



LED Oval-Shaped Light Fitting Series 3610...

Applications:

Humid, wet and dusty interior areas, in areas with extreme operating conditions, for small spacing, areas that are difficult to access, purpose of signalization with coloured LED etc.
(For damp and cold ambient conditions with low duty cycles and in the case of aggressive atmosphere, please contact us)

Design:

Housing: Cast aluminium, unpainted.
Wire guard: Steel, passivated.

Glass bowl: Silicate, frosted with internal prism structure, silicone gasket.

Reflector: Aluminium painted, with LED-Linear modules.

Connection: 2-pole. Earthing by separate screw at the enclosure.

Cable entries: 2 x M20 x 1.5.

Mounting system: 2 integral fixing lugs

Note: Cable glands are not included in the scope of delivery. Please order separately (See accessories).

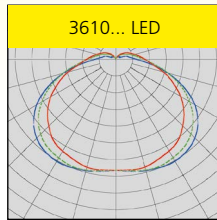

Technical Data:

LED: Linear modules 4,000 K, CRI > 80, service life L_{80} > 100,000 h at 25 °C ambient temperature, service life L_{80} > 90,000 h at max. ambient temperature
ECG: 220-240 V, 50/60 Hz, overload and short circuit protection.
Ambient temperature: -20 °C up to +35 °C

Options:

– coloured LEDs, for signal applications

Product highlights:

- robust light fitting for rough environment
- ideal for small spacing
- homogeneous illumination by using frosted diffusers, comfortable perception of light (3610 L..)
- quick mounting with outer fixing points
- **sustainable**, control gear and LED-module replaceable by qualified personnel on-site (3610 L..)

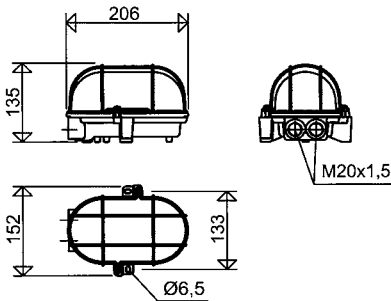

3610 L.. with coloured LED for signalling application

Article no.	Type	Connected load [W]	Luminous flux [lm]	Luminous efficacy [lm/W]	Substitute for *	Weight [kg] without packing material
-------------	------	--------------------	--------------------	--------------------------	------------------	--------------------------------------

3610 L..



36102 0031	3610 L04	5,0	550	110	1 x 40W	1,2
36102 0032	3610 L10	9,5	960	101	1 x 75W	1,2

* The given information is for rough orientation only. In each individual case a lighting calculation is necessary.

3610



Design:

like LED type but

Glass bowl: clear, with internal prism without reflector **with lamp socket:** E27

Technical Data:

ECG: 230 V, 50/60 Hz

Ambient temperature: -20 °C up to +25 °C

36100 0007	3610	for LED-lamps E27/A60, max. 10,5W	1,2
------------	-------------	-----------------------------------	-----

Accessories / Spare Parts

Article No.	Type	
90075 9002	ABD 3610 F	cover, frosted spare glass, for 3610...
90075 9000	ABD 3610	cover, spare glass clear, for 3610...
36101 9000	SK 3610	spare wire guard
59600 9001	DT 596 SIL	spare gasket
Cable glands M20 x 1,5		
25610 9000	2561	plastic gland M20 x 1.5
25730 9000	2573	plastic threaded blanking plug M20 x 1.5

! Properties, limitations and details for controlling LED-light fittings:

■ See "Technical Supplement"

All data are correct at the time of printing. Actual technical data can be found under www.schuch.de.

Compact LED Fitting Series 3611 ...



Applications:

Humid, wet and dusty locations, corridors, staircases, under canopies and balconies, areas with rough conditions of operation, constricted space, almost inaccessible locations, runways, cable channels, stair towers, walkable low temperature booths (For damp and cold ambient conditions with low duty cycles and in the case of aggressive atmosphere, please contact us)

Design:

Housing: Die-cast aluminium, painted in white, all operating components located inside the housing and wired ready for connection.
Diffuser: PC satined, foamed silicone gasket.
Connection terminal: 3-poles.
Cable entry: 1 plug M20 at the front side.
Mounting: 2 outer fixing points.

Note:

This light fitting is not suitable for application in areas with permanent high humidity in combination with only short periods of operation, such as sewage or stormwater retention tanks or water treatment plants.

Technical data:

LED: Linear modules, 4,000 K, CRI > 80, service life $L_{90} > 50,000$ h at 25 °C ambient temperature, service life $L_{80} > 70,000$ h and $L_{70} > 100,000$ h at max. ambient temperature

ECG: 220-240 V, 50/60 Hz, overload and short circuit protection.

Ambient temperatures: -20 °C up to +30 °C

Options:

- coloured LEDs, for signal applications
- cable looping at 1 small side
- for connection to 24 V DC-supply (24 V DC)
- for higher ambient temperatures (H..)
- for wide temperature ranges (T40 H..)
- seawater-resistant version
- vibration-resistant design
- for outdoor areas (AUS)

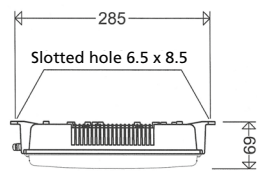
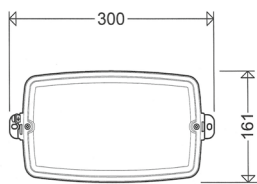
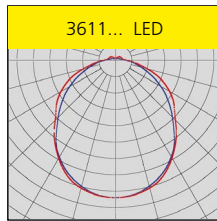

Product highlights:

- robust die-cast aluminium luminaire for rough environments
- ideal for small spacing
- homogeneous illumination by using frosted diffusers, comfortable perception of light
- best suitable in the food industry and in the food processing industry especially in risky areas falling under the IFS standards (International Featured Standard Food)
- quick mounting with outer fixing points
- sustainable, control gear and LED-module replaceable by qualified personnel on-site
- future proof by using standardised LED-modules (Zhaga) and long-term availability of spare parts

Article no.	Type	Connected load [W]	Luminous flux [lm]	Luminous efficacy [lm/W]	Substitute for *	Weight [kg] without packing material
-------------	------	--------------------	--------------------	--------------------------	------------------	--------------------------------------

3611...



36110 0006	3611 L05	6,0	660	110	1 x 8W	0,9
36110 0007	3611 L10	10,0	1.180	118	1 x 18W	0,9

* The given information is for rough orientation only. In each individual case a lighting calculation is necessary.



! Properties, limitations and details for controlling LED-light fittings:
See "Technical Supplement"

All data are correct at the time of printing. Actual technical data can be found under www.schuch.de.

Accessories / Spare Parts

Article No.	Type	
36004 9003	ABD 3611 F	cover, frosted PC diffuser, for 3611...



Compact Dustproof/Waterproof LED-Light Fitting Series 164KL... G2

Applications:

Humid, wet and dusty interior areas, walkable low temperature cabins, restaurants, supermarkets, hotels etc., above doors, entrances and exits, roofed outdoor areas etc.

(For damp and cold ambient conditions with low duty cycles and in the case of aggressive atmosphere, please contact us)

Design:

Housing: Glass fibre reinforced polyester, foamed silicone gasket.

Diffuser: PMMA frosted for glare limitation.

Clips: Single-piece plastic clips (KK).

Reflector: Aluminium painted, detachable, carrying the electrical components.

Connection terminal: 3 poles

Cable entries: Variable, at the ends and top of the housing, 2 plugs M20.

Mounting system: 2 holes for ceiling mounting. Sealing and pressure disks are supplied inside the fitting.

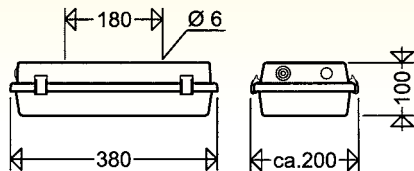

Technical data:

LED: Linear modules, 4,000 K, CRI > 80, service life $L_{90} > 50,000$ h at 25 °C ambient temperature, service life $L_{80} > 70,000$ h and $L_{70} > 100,000$ h at max. ambient temperature

ECG: 220-240 V, 50/60 Hz, overload and short circuit protection.

Ambient temperature: -20 °C up to +30 °C

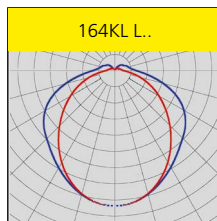

Options:

- 2,200 K, 2,700 K, 3,000 K, 5,000 K, 6,500 K; light colours (822, 827, 830, 850, 865)
- 1,800 K; light colour (518), amber for insect-friendly lighting in outdoor areas etc.
- coloured LEDs, for signal applications
- cable looping at 1 small side

- rear cable entry
- for connection to 24 V DC-supply (24 V DC), Type ... L08G2
- stainless steel clips (KE)
- for higher ambient temperatures (H..)
- for wide temperature ranges (T40 H..)
- for outdoor areas (AUS)

Product highlights:

- quality luminaire with above-average mechanical strength
- homogeneous illumination by using frosted diffusers, comfortable perception of light and brilliant glare limitation
- sustainable, control gear and LED-module replaceable by qualified personnel on-site
- future proof by using standardised LED-modules (Zhaga) and long-term availability of spare parts

Dustproof/Waterproof Light Fittings

Wall bracket 45 ° (WA45)

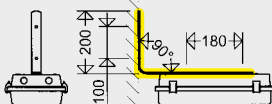

Wall bracket 90 ° (WA90)

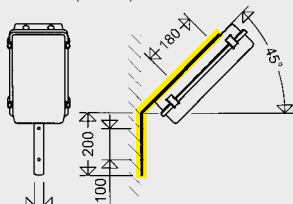

Ceiling bracket (DA)

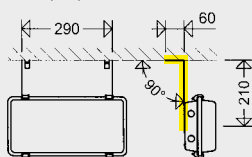

- ! Properties, limitations and details for controlling LED-light fittings: See "Technical Supplement"

All data are correct at the time of printing. Actual technical data can be found under www.schuch.de.

Article no.	Type	Connected load [W]	Luminous flux [lm]	Luminous efficacy [lm/W]	Substitute for *	Weight [kg] without packing material
-------------	------	--------------------	--------------------	--------------------------	------------------	--------------------------------------

164KL...

Article no.	Type	Connected load [W]	Luminous flux [lm]	Luminous efficacy [lm/W]	Substitute for *	Weight [kg] without packing material
16407 0032	164KL L08G2	5	680	136	1 x 11W	1,0
16407 0034	164KL L15G2	10	1.350	135	1 x 24W	1,0

*The given information is for rough orientation only. In each individual case a lighting calculation is necessary.

Accessories / Spare Parts

Article no.	Type	
Spare glasses PMMA frosted		
16413 9007	ABD 164KL F G2	cover, frosted PMMA diffuser, for 164KL... G2
Cable entries		
90063 9000	2511	blanking plug M20
25610 9000	2561	plastic cable gland M20 x 1,5
25600 9000	2560	plastic cable gland M25 x 1,5
Mounting brackets		
90232 0012	WA 45 ALU	wall bracket 45°
90232 0013	WA 90 ALU	wall bracket 90°
90232 0004	DA	1 pair of ceiling/wall bracket 90 °
Fasteners		
90123 9003	163 KK VE08	plastic (packing unit 8)
90123 9002	163 KE VE08	stainless steel (packing unit 8)



Small High Impact Resistant Dust-/Waterproof LED-Light Fittings with Diffusers Series 130... / 131... G2

Applications:

Humid, wet and dusty interior areas, corridors, staircases, under canopies and balconies, walkable low temperature cabins, restaurants, supermarkets, hotels, areas which are difficult to access etc. (For damp and cold ambient conditions with low duty cycles and in the case of aggressive atmosphere, please contact us)

Design:

Housing: Polycarbonate, white, silicone gasket.
Diffuser: Polycarbonate frosted, at one side with multiple hinge for suspending and unhinging the diffuser, captive

stainless steel screw on the other side for closing the fitting.

Reflector: Aluminium painted, with LED and all electrical components, ready wired for installation.

Connection: Via 3-pole terminal.

Cable entry:

Series 130...: 1 grommet M20 at the locking side.

Series 131... G2: 1 grommet M20 at each front side.

Mounting: 2 borings serve for direct ceiling mounting. Sealing and pressure disks included.

Technical data:

LED: Highpower LED, 4,000 K, CRI > 80, service life L_{90} > 50,000 h at 25 °C ambient temperature, service life L_{80} > 70,000 h and L_{70} > 100,000 h at max. ambient temperature

ECG: 220-240 V, 50/60 Hz, overload and short circuit protection.

Ambient temperature: -20 °C up to +30 °C

Options:

- coloured LEDs, for signal applications
- cable looping at 1 small side (131... G2)
- rear cable entry
- for connection to 24 V DC-supply (24 V DC), Type ... L07
- for higher ambient temperatures (H..)
- for wide temperature ranges (T40 H..)

Series 130...

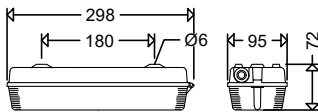

Series 131... G2

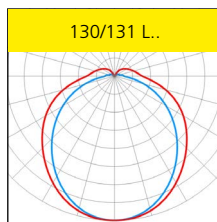
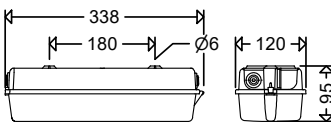

Product highlights:

- robust, impact resistant compact light fitting entirely made from PC
- ideal for small spacing
- homogeneous illumination by using frosted diffusers comfortable perception of light
- best suitable in the food industry and in the food processing industry especially in risky areas falling under the IFS standards (International Featured Standard Food)
- sustainable, control gear and LED-module replaceable by qualified personnel on-site
- future proof by using standardised LED-modules (Zhaga) and long-term availability of spare parts

Wall bracket 90° (WA90)

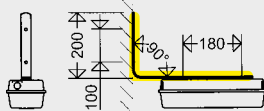

Wall bracket 45° (WA45)

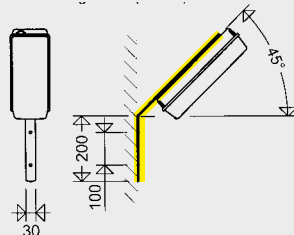

Ceiling bracket (DA)

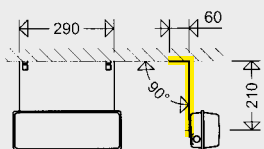

Wire guard 130/131...

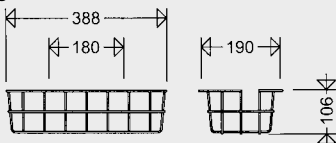

Article no.	Type	Connected load [W]	Luminous flux [lm]	Luminous efficacy [lm/W]	Substitute for *	Weight [kg] without packing material
-------------	------	--------------------	--------------------	--------------------------	------------------	--------------------------------------

130... / 131... G2

13003 0051	130 L07	5	660	132	1 x 11W	0,4
13101 0062	131 L07G2	5	650	130	1 x 11W	0,5
13101 0064	131 L13G2	10	1.300	130	2 x 11W	0,5

*The given information is for rough orientation only. In each individual case a lighting calculation is necessary.

Accessories / Spare Parts

Article no.	Type	
13011 9007	ABD 130 F	cover, frosted PC diffuser, for 130...
13111 9006	ABD 131 F	cover, frosted PC diffuser, for 131...
13111 9007	ABD 131 F G2	cover, frosted PC diffuser, for 131... G2
90062 9000	2510	spare-grommet, M16 (for 130...)
90063 9000	2511	spare-grommet, M20 (for 131...)
25610 9000	2561	plastic cable gland, M20 x 1,5 (for 131...)
90004 0009	SK 130/131/132	Wire guard thick layer passivated
90232 0012	WA 45 ALU	wall bracket 45°
90232 0013	WA 90 ALU	wall bracket 90°
90232 0004	DA	ceiling bracket

Properties, limitations and details for controlling LED-light fittings:

See "Technical Supplement"

All data are correct at the time of printing. Actual technical data can be found under www.schuch.de.

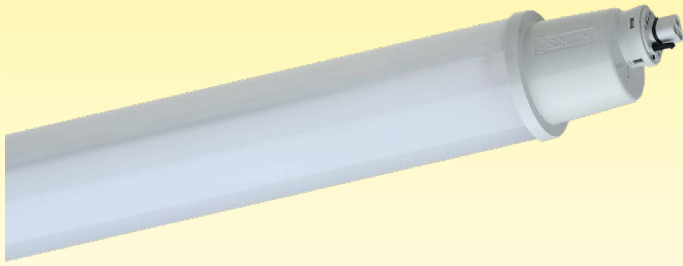

PRIMO XR Gas-tight LED-Tube Light Fitting Series 107...

Application:

Areas which are subject to harmful gas loads, which may damage the LEDs or even cause their total failure, e. g. ammonia and sulfur compounds in companies in the chemical industry, papermaking or tire production and storage, in chlorinated environments such as swimming pools and indoor pools, etc. Areas where the luminaires are exposed to jet and pressurised water, high humidity, moisture and dust, for infrequent or occasional operation (inspection lighting) and in the automotive industry. For use in agriculture and animal husbandry with high ammonia concentration, see version 107... XR LW.

Design:

Tube: Acrylic glass (PMMA), modified for higher impact resistance, frosted for glare limitation, with welded end and connection caps.
Reflector: Aluminum, with LED Module and ECG.
Connection: 3-pole (DIMD 5-pole) quick connection plug (FastConnect). End cap with integrated plug, socket included in scope of delivery.
Mounting: Variable mounting distance by means of stainless steel pipe clamps (included in scope of delivery). For direct ceiling and wall mounting.

Note:

The housing materials used for the PRIMO XR show good chemical resistance against a variety of chemicals. See also paragraph "Plastics in SCHUCH luminaires" in the "Technical supplement".

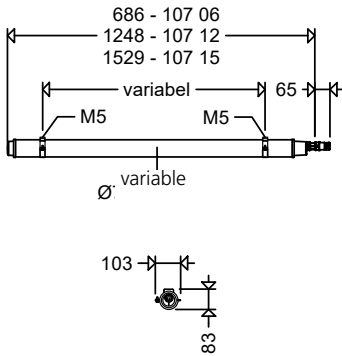

For vertical installation, please note:

Plug part must face downwards. Through wiring not possible. For Cable looping please use accessory 107 SVDA 3 or 107 SVDA-5 for DIMD.

Technical data Version 107... XR:

LED: Linear modules 4,000 K, CRI > 80, service life $L_{90} > 50,000$ h at 25 °C ambient temperature, service life $L_{80} > 70,000$ h and $L_{70} > 100,000$ h at max. ambient temperature

ECG: 220-240 V, 50/60 Hz, overload and short-circuit protection

Ambient temperature: -20 °C up to +40 °C

Options:

- 2,200 K, 2,700 K, 3,000 K, 5,000 K, 6,500 K; light colours (822, 827, 830, 850, 865)
- 1,800 K; light colour (518), amber for insect-friendly lighting in outdoor areas etc.
- high colour rendering index $R_a > 90$
- green LEDs, for lighting potato stores
- coloured LEDs, for signal applications

- through-wiring (DV), 3 x 1.5 mm² or 5 x 1.5 mm² for DIMD types
- for higher ambient temperatures (H50)
- for wide temperature ranges (T40 H50)
- protection class II (SKII)
- for connection to a central power supply system (ZB)
- Corridor Mode (DIMC)

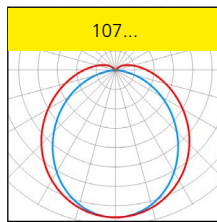

Product highlights:

- impact-resistant PMMA tube with high mechanical strength
- extremely tight against harmful gases, hermetically sealed thanks to welding of pipe and end caps as well as a perfectly sealed quick connector.
- dust- and pressure water tight, (IP68, 3 m/ 30 min).
- IPX9K-tested (high pressure / steam jet cleaning)
- can also be used in unprotected outdoor areas
- homogeneous illumination by using a frosted tube, comfortable perception of light, brilliant glare limitation
- fast connection thanks to integrated FastConnect quick connection plug
- fast mounting with variable mounting distances by means of movable stainless steel pipe clamps



Article no.	Type	Connected load [W]	Luminous flux [lm]	Luminous efficacy [lm/W]	Substitute for *	Weight [kg] without packing material
-------------	------	--------------------	--------------------	--------------------------	------------------	--------------------------------------

107... XR (Xtreme Resistance)

		IP68	IPX9K	⊕	⚠	⚡
10702 0001	107 06L12 XR	10	1.300	130	1 x 18W	1,3
10702 0002	107 06L20 XR	16	2.190	137	2 x 18W	1,3
10702 0003	107 12L22 XR	15	2.260	151	1 x 36W	2,2
10702 0005	107 12L42 XR	29	4.370	151	2 x 36W	2,2
10702 0004	107 15L34 XR	24	3.710	155	1 x 58W	2,6
10702 0006	107 15L60 XR	42	6.270	149	2 x 58W	2,6

* The given information is for rough orientation only. In each individual case a lighting calculation is necessary.

DIMD versions are compatible with LIMAS Line Light Management System.

Properties, limitations and details for controlling LED-light fittings:

See "Technical Supplement"

All data are correct at the time of printing. Actual technical data can be found under www.schuch.de.

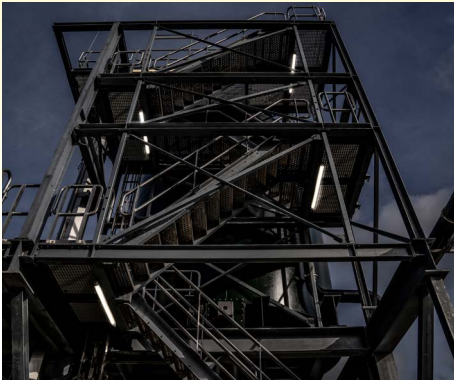

Article no.	Type	Connected load [W]	Luminous flux [lm]	Luminous efficacy [lm/W]	Substitute for *	Weight [kg] without packing material
-------------	------	--------------------	--------------------	--------------------------	------------------	--------------------------------------

107... XR DIMD (Xtreme Resistance)



10702 0021	107 06L12 XR DIMD	10	1.300	130	1 x 18W	1,3
10702 0022	107 06L20 XR DIMD	16	2.190	137	2 x 18W	1,3
10702 0023	107 12L22 XR DIMD	15	2.260	151	1 x 36W	2,2
10702 0025	107 12L42 XR DIMD	29	4.370	151	2 x 36W	2,2
10702 0024	107 15L34 XR DIMD	24	3.710	155	1 x 58W	2,6
10702 0026	107 15L60 XR DIMD	42	6.270	149	2 x 58W	2,6

107... XR LW



for use in stables contaminated with ammonia and in agricultural premises

Application:

Stables in agriculture, animal husbandry, fattening and rearing companies etc., rooms with high dust pollution and increased fire risk, e.g. barns, straw and feed stores

etc., areas where the light fittings are exposed to jet and pressurized water, e.g. cleaning with steam jets.

Technical data Version 107... XR LW:

LED: Linear modules 4,000 K, CRI > 80, L₈₀ > 50,000 h and L₇₀ > 100,000 h at max. ambient temperature
 ECG: 220-240 V, 50/60 Hz, overload and short-circuit protection
 Ambient temperature: -20 °C up to +35 °C

Additional advantages:

- permanently ammonia-resistant
- flicker-free light for stress avoidance and promotion of animal welfare
- low-glare light through satined tube

10703 0015	107 12L42 XR LW	30	3.900	130	2 x 36W	2,2
10703 0014	107 15L34 XR LW	28	3.660	131	1 x 58W	2,6
10703 0016	107 15L60 XR LW	43	5.700	133	2 x 58W	2,6
10703 0025	107 12L42 XR LW DIMD	30	3.900	130	2 x 36W	2,2
10703 0024	107 15L34 XR LW DIMD	28	3.660	131	1 x 58W	2,6
10703 0026	107 15L60 XR LW DIMD	43	5.700	133	2 x 58W	2,6

* The given information is for rough orientation only. In each individual case a lighting calculation is necessary.

DIMD versions are compatible with LIMAS Line light management system.

Gas-tight encapsulated light sensor

Specially developed for use in environments contaminated with harmful gases, our new XR DS light sensor is ideal for animal houses contaminated with ammonia. Robustly constructed and gas-tight encapsulated, it offers outstanding durability and reliability in these demanding areas.

See catalog chapter Light Management Systems/LIMAS Line.

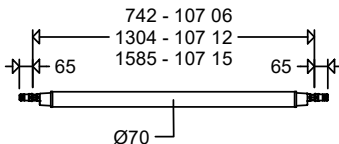

Through wiring

The light fittings (PRIMO XR and PRIMO LW) are available with through wiring installed at the factory only. The dimensions of the light fitting change due to the quick plug connection integrated into the connection cap on both sides (see dimension drawing). For the last luminaire in the light band, the socket part on the luminaire must be covered with a locking piece (see accessories / spare parts).

Accessories / Spare Parts

Article no.	Type	
Cable entries		
90278 9005	107 SVDA-3	plug-in connection double connection to looping in/out 3-pole grey
90278 9006	107 SVDA-5	plug-in connection double connection to looping in/out, 5-pole grey for DIM
Locking pieces for luminaires with through-wiring		
90278 9007	107 VS-3	3-pole locking piece grey
90278 9008	107 VS-5	5-pole locking piece grey
Accessories		
90272 9003	107 RO V4A P	stainless steel pipe clamp - 1.457 Mounting set (1 pair)

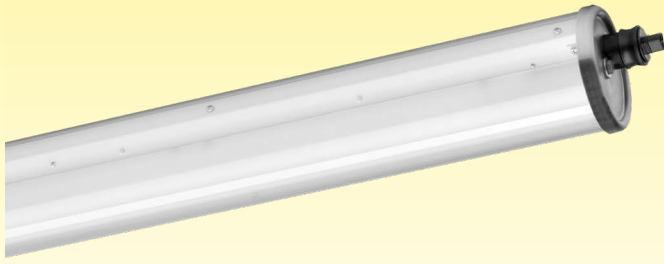

TUBEO Tubular LED Light Fitting Series 110...

Applications:

Public, commercial and industrial areas which are endangered by water jets, water spray, dusty atmospheres or high mechanical stress (vandalism). Car washes, inspections pits, docks, ships (For damp and cold ambient conditions with low duty cycles and in the case of aggressive atmosphere, please contact us)

Design:

Housing: Impact and shatter resistant clear PMMA tube, Ø 100 mm.
Fastener: Tubular locking cap made of

stainless steel with foamed gasket, special element for compensation of length expansion.

Reflector: Sheet steel with electric components and frosted cover for glare limitation.

Connecting: 3-pole (DIMD 5-pole) quick connection plug IP69K (**FastConnect**). Plug integrated and internally pre-wired, receptacle included for mains assembly.

Mounting: Supplied with 2 stainless steel pipe clamps.

Technical data:

LED: Linear modules 4,000 K, CRI > 80, service life $L_{90} > 50,000$ h at 25 °C ambient temperature, service life $L_{80} > 70,000$ h and $L_{70} > 100,000$ h at max. ambient temperature

ECG: 220-240 V, 50/60 Hz, overload and short-circuit protection

Ambient temperature: -20 °C up to see article tables

Options:

- 2,200 K, 2,700 K, 3,000 K, 5,000 K, 6,500 K; light colours (822, 827, 830, 850, 865)
- 1,800 K; light colour (518), amber for insect-friendly lighting in outdoor areas etc.
- high colour rendering index $R_a > 90$
- coloured LEDs, for signal applications
- narrow wide beam (TB)

- through-wiring (DV), 3 x 2.5 mm² or 5 x 2.5 mm² for DIMD types
- cover made of polycarbonate (PC), protective tube (4 x IK10/80 Joule)
- for wide temperature ranges (T40 H..)
- protection class II (SKII)
- for connection to a central power supply system (ZB)
- Corridor Mode (DIMC)

Note:

When installing in a saline atmosphere, please request the special version.

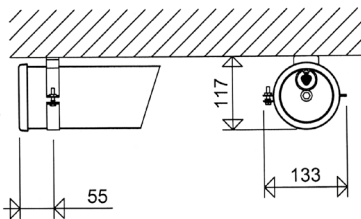
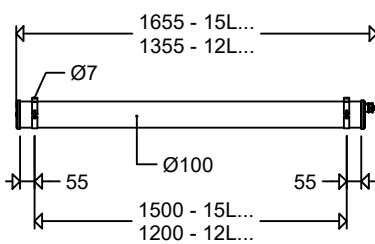

For vertical installation, please note:

Plug part must face downwards. Through wiring not possible. For Cable looping please use accessory 110 SVDA 3.

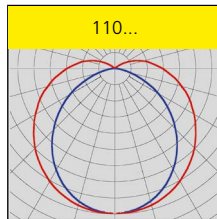

Product highlights:

- sturdy and extremely rugged tubular light fitting for application in rough environments
- impact-resistant PMMA tube with high mechanical strength
- optional high-impact resistant polycarbonate tube 4 x IK10 (80 joule min.) for applications in the food industry, areas with a risk of vandalism etc.
- dust- and pressure water tight, (IP68, 3 m/ 30 min.)
- IPX9K-tested (high pressure / steam jet cleaning)
- homogeneous illumination by using frosted covers, comfortable perception of light, brilliant glare limitation
- **FastConnect quick connection plug** - electrical connection without opening the luminaire
- fast mounting with variable mounting distances by means of movable stainless steel pipe clamps
- sustainable, control gear and LED-module replaceable by qualified personnel on-site
- future proof by using standardised LED-modules (Zhaga) and long-term availability of spare parts

Article No.	Type	Connected load [W]	Luminous flux [lm]	Luminous efficacy [lm/W]	Amb. temp. max. [°C]	Substitute for ca. *	(without packing material)
11000 0003	110 12L22	15	2.390	159	45	1 x 36W	4,4
11000 0005	110 12L42	27	4.240	157	35	2 x 36W	4,4
11000 0004	110 15L34	21	3.440	164	45	1 x 58W	5,0
11000 0006	110 15L60	39	6.160	158	35	2 x 58W	5,0
11000 0007	110 15L100	67	10.360	155	35	3 x 58W	5,1

110...



* The given information is for rough orientation only. In each individual case a lighting calculation is necessary.

Properties, limitations and details for controlling LED-light fittings:

See "Technical Supplement"

All data are correct at the time of printing. Actual technical data can be found under www.schuch.de.

Article No.	Type	Connected load [W]	Luminous flux [lm]	Luminous efficacy [lm/W]	Amb. temp. max. [°C]	Substitute for ca. *	(without packing material)
-------------	------	--------------------	--------------------	--------------------------	----------------------	----------------------	----------------------------

110... DIMD



11000 0013	110 12L22 DIMD	15	2.390	159	45	1 x 36W	4,4
11000 0015	110 12L42 DIMD	27	4.240	157	35	2 x 36W	4,4
11000 0014	110 15L34 DIMD	21	3.440	164	45	1 x 58W	5,0
11000 0016	110 15L60 DIMD	39	6.160	158	35	2 x 58W	5,0
11000 0017	110 15L100 DIMD	67	10.360	155	35	3 x 58W	5,1

DIMD versions are compatible with LIMAS Line Light Management System.

110... H50



for high ambient temperatures up to +50 °C

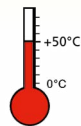

11000 0055	110 12L42 H50	27	4.240	157	50	2 x 36W	4,4
11000 0056	110 15L60 H50	38	6.160	162	50	2 x 58W	5,1

* The given information is for rough orientation only. In each individual case a lighting calculation is necessary.

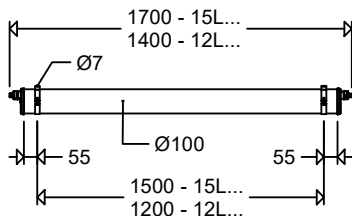

Through wiring

The light fittings are available with through wiring installed at the factory only. The dimensions of the light fitting change due to the quick plug connection integrated into the connection cap on both sides (see dimension drawing). For the last luminaire in the light band, the socket part on the luminaire must be covered with a locking piece (part of the delivery).

Accessories / Spare Parts

Article No.	Type	
90272 9001	110 RO V P	1 pair of pipe clamps, stainless steel
90273 9001	ABD 110 036	cover, tube PMMA clear, for 110 12 ...
90273 9002	ABD 110 058	cover, tube PMMA clear, for 110 15 ...
90273 9003	ABD 110 036 PC	cover, tube PC clear, for 110 12 ...
90273 9004	ABD 110 058 PC	cover, tube PC clear, for 110 15 ...
90049 0002	183 S	hook for chain suspension, stainless steel
90278 9001	110 SVDA-3	splitter connector for in-out wiring on one end
90278 9002	110 SVDA-5	splitter connector for in-out wiring on one end, 5-pole version for DIMD



LED-Sheet Steel Light Fitting Series 190...

Applications:

Industrial, craftsmen and commercial facilities with extreme conditions, aggressive environments (e.g. oil, grease) or high mechanical exposure, paint shops and spray booths (non-hazardous areas).

(For damp and cold ambient conditions with low duty cycles and in the case of aggressive atmosphere, please contact us)

Design:

Housing: Sheet steel, light grey, powder coated (RAL 7035).

Safety glass: Frameless, clear, internal hinges, tilttable.

Reflector: Aluminium painted, with LED-modules, glare limitation modules

and all electrical components screwed to the glass.

Central locking: Internal, to be opened from outside with 5 mm allen key, inner hinges on the opposite side.

Terminal: 5-pole terminal, clamping range 2.5 mm² max.

Cable entries: 3 entries M20 x 1.5 (2 glands and 2 screw plugs).

Looping the mains cable at one end of the housing up to 5 x 2.5 mm² possible.

Mounting:

2 fixing holes Ø 9 mm,

Sealing and pressure disks included.

Use mounting screws Ø 6 mm.

Note:

This light fitting is not suitable for application in areas with permanent high humidity in combination with only short periods of operation, such as sewage or stormwater retention basins or water treatment plants.

In such cases we recommend the use of our 107... G2 (PRIMO XR) series.

Technical data:

LED: Linear modules 4,000 K, CRI > 80, service life L₉₀ > 50,000 h at 25 °C ambient temperature, service life L₈₀ > 70,000 h and L₇₀ > 100,000 h at max. ambient temperature

ECG: 220-240 V, 50/60 Hz, overload and short-circuit protection

Ambient temperature: -20 °C up to see article tables

Options:

- 2,200 K, 2,700 K, 3,000 K, 5,000 K, 6,500 K; light colours (822, 827, 830, 850, 865)
- coloured LEDs, for signal applications
- through-wiring (DV), 5 x 2,5 mm²
- stainless steel version (E.), painted
- special painting in RAL colours
- for lower ambient temperatures (T40),

down to -40 °C

- for connection to a central power supply system (ZB)

- dimming function via DALI-2 interface, compatible with LIMAS Line wired Light Management System (DIMD)

- Corridor Mode (DIMC)

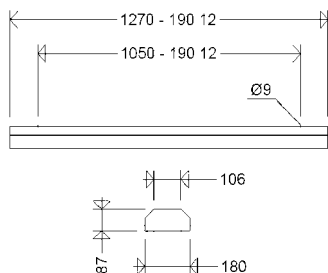
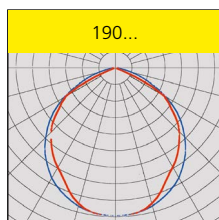

Product highlights:

- extremely flat and robust design
- smooth sheet steel housing without contamination-prone external locking parts
- comfortable central locking system with internal hinges
- reflector and cover in sandwich design to protect the LED-Modules from mechanical or electrostatic damages due to accidental contact
- homogeneous illumination by using glare limitation modules
- sustainable, control gear and LED-module replaceable by qualified personnel on-site
- future proof by using standardised LED-modules (Zhaga) and long-term availability of spare parts



Article no.	Type	Quantity of ECG	Connected load [W]	Luminous flux [lm]	Luminous efficacy [lm/W]	Ambient temperature max. [°C]	Substitute for ca. *	Weight [kg] without packing material
-------------	------	-----------------	--------------------	--------------------	--------------------------	-------------------------------	----------------------	--------------------------------------

190...



19002 0014	190 12L40	1	32	4.330	135	60	1 x 36 / 1 x 58	8,5
19002 0015	190 12L60	1	46	6.200	135	55	2 x 36 / 2 x 58	8,7

* The given information is for rough orientation only. In each individual case a lighting calculation is necessary.

Accessories / Spare Parts

Article No.	Type	
Spare glass clear		
19001 9002	ABD 190 12	cover, spare glass clear, for 190 12
Cable entries		
25610 9000	2561	plastic cable gland M20 x 1,5
25730 9000	2573	threaded blanking plug M20x1,5
Mounting accessories		
26000 0004	WW 26 P	1 pair wall angle brackets
26000 0002	WW 26 30 P	1 pair wall angle brackets 30°
26000 0003	WW 26 45 P	1 pair wall angle brackets 45°
90000 0002	DS 15A P	1 pair ceiling brackets, galvanized steel
90032 0002	DS 15AV P	1 pair ceiling brackets, stainless steel

Properties, limitations and details for controlling LED-light fittings:

See "Technical Supplement"

All data are correct at the time of printing. Actual technical data can be found under www.schuch.de.

LED-Steep roof light fitting Series 185...

Applications:

Industrial, tradesmen's and commercial facilities with extreme conditions, aggressive environments (e.g. oil, grease) or high mechanical exposure, clean rooms, spray booths and spraying rooms (not EX), sand blasting rooms (SSK-versions) etc.

(For damp and cold ambient conditions with low duty cycles and in the case of aggressive atmosphere, please contact us)

Design:

Housing: Sheet steel, light grey, powder coated (RAL 7035), silicone foam seal
Safety glass: Frameless, clear, hinged, tiltable.

Reflector: Hinged; white painted sheet steel; detachable, with LED-modules and frosted glare limitation modules.

Central locking: Internal, to be opened from outside with 5 mm allen key, inner hinges on the opposite side.

Terminal: 5-pole terminal, clamping range 2.5 mm² max.

Cable entries: 3 entries
M25 x 1.5 (2 glands and 2 screw plugs). Looping the mains cable at one end of the housing up to 5 x 2.5 mm² possible.

Mechanical installation:

Mounting accessories see spare parts/ accessories.

Technical data:

LED: Linear modules 4,000 K, CRI > 80, service life L₉₀ > 50,000 h at 25 °C ambient temperature, service life L₈₀ > 70,000 h and L₇₀ > 100,000 h at max. ambient temperature

ECG: 220-240 V, 50/60 Hz, overload and short-circuit protection

Ambient temperature: -20 °C up to see article tables

Options:

- 2,200 K, 2,700 K, 3,000 K, 5,000 K, 6,500 K; light colours (822, 827, 830, 850, 865)
- coloured LEDs, for signal applications
- through-wiring (DV), 5 x 2,5 mm²
- stainless steel version (E.), painted
- special painting in RAL colours
- for higher ambient temperatures (H..)
- for wide temperature ranges (T40 H..)
- increased resistance (ER), against corrosive atmospheres
- high resistance (HR), against corrosive atmospheres
- with increased luminous flux (up to 34,000 lm) and optics (T/TB) for shelf storage aisles, workplace lighting, etc.
- for connection to a central power supply system (ZB)
- Corridor Mode (DIMC)



Note:

This light fitting is not suitable for application in areas with permanent high humidity in combination with only short periods of operation, such as sewage or stormwater retention basins or water treatment plants.

In such cases we recommend the use of our 107... G2 (PRIMO XR) series.

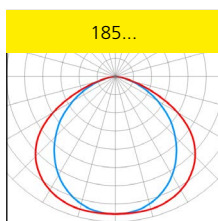
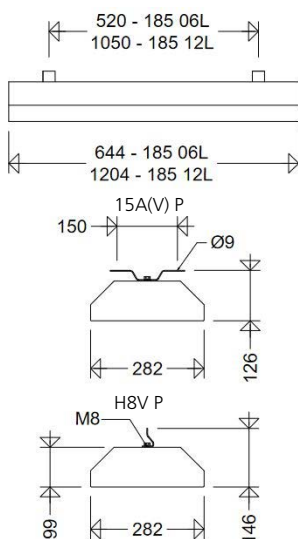

Product highlights:

- extremely flat and robust design
- smooth housing with all latches inside the housing
- comfortable central locking system with internal hinges
- perfect protection of the LED from mechanical or electrostatic damages through glare limitation elements on top the led
- homogeneous, glarefree illumination with frosted glare limitation elements, comfortable perception of light, brilliant glare limitation
- retrofittable installation frames and swivel arm mountings (modular construction)
- inexpensive cable looping possible
- suitability for paint booths LABS-tested according to VDMA24364-C2-L
- 185 12L.. Ball-proof tested for use in sports halls
- sustainable, control gear and LED-module replaceable by qualified personnel on-site
- future proof by using standardised LED-modules (Zhaga) and long-term availability of spare parts



Article no.	Type	Quantity of ECG	Connected load [W]	Luminous flux [lm]	Luminous efficacy [lm/W]	Ambient temperature max. [°C]	Substitute for ca. *	Weight [kg] without packing material
-------------	------	-----------------	--------------------	--------------------	--------------------------	-------------------------------	----------------------	--------------------------------------

185...



18501 0031	185 06L30	1	22	3.100	141	55	1 x 58W	7,9
18501 0032	185 06L45	1	32	4.660	146	55	2 x 36W	7,9
18501 0033	185 06L60	1	43	6.190	144	45	2 x 58W	7,9
18501 0001	185 12L60	1	42	5.830	139	55	2 x 58W	13,3
18501 0002	185 12L90	1	63	9.100	144	55	3 x 58W	13,8
18501 0003	185 12L120	1	84	11.660	139	45	4 x 58W	13,8

* The given information is for rough orientation only. In each individual case a lighting calculation is necessary.

Properties, limitations and details for controlling LED-light fittings:

See "Technical Supplement"

All data are correct at the time of printing. Actual technical data can be found under www.schuch.de.

Article no.	Type	Quantity of ECG	Connected load [W]	Luminous flux [lm]	Luminous efficacy [lm/W]	Ambient temperature max. [°C]	Substitute for ca. *	Weight [kg] without packing material
-------------	------	-----------------	--------------------	--------------------	--------------------------	-------------------------------	----------------------	--------------------------------------

NEW 185... DIMD



dimmable via DALI interface

Design:

Same as standard version, but with DALI-2-ECG and 2 additional clamping points. Dimming range 1 -100 %. Compatible with LIMAS Line Light Management System.

18501 0036	185 06L30 DIMD	1	22	3.100	141	55	1 x 58W	7,9
18501 0037	185 06L45 DIMD	1	32	4.660	146	55	2 x 36W	7,9
18501 0038	185 06L60 DIMD	1	43	6.190	144	45	2 x 58W	7,9
18501 0006	185 12L60 DIMD	1	42	5.830	139	55	2 x 58W	13,3
18501 0007	185 12L90 DIMD	1	63	9.100	144	55	3 x 58W	13,8
18501 0008	185 12L120 DIMD	1	84	11.660	139	45	4 x 58W	13,8

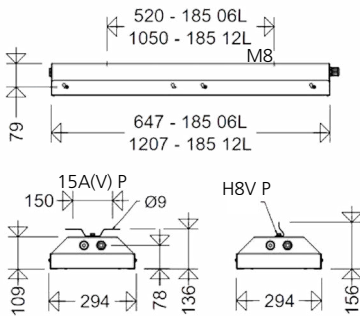

185... SSK



for blasting rooms and cabins

Applications:

Rooms and cabins where blasting material (sand, glass beads, etc.) is used.

Design:

As standard version 185..., but: protruding, easily replaceable polycarbonate cover in stainless steel frame to protect the safety glass from damage by blasting material. The replacement interval may differ depending on the blasting material used.

18501 0041	185 06L30 SSK	1	22	3.100	141	55	1 x 58W	9,3
18501 0042	185 06L45 SSK	1	32	4.660	146	55	2 x 36W	9,3
18501 0043	185 06L60 SSK	1	43	6.190	144	45	2 x 58W	9,3
18501 0011	185 12L60 SSK	1	42	5.830	139	55	2 x 58W	16,2
18501 0012	185 12L90 SSK	1	63	9.100	144	55	3 x 58W	16,7
18501 0013	185 12L120 SSK	1	84	11.660	139	45	4 x 58W	16,7

* The given information is for rough orientation only. In each individual case a lighting calculation is necessary.

Attention: Version 185... SSK cannot be combined with frame for recessed installation or dust protection cover.

Installation dimensions

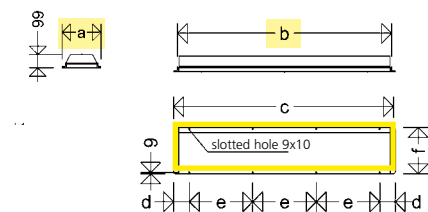

Type	a	b	c	d	e	f
EB 82. 06L	302	660	710	55	300	348
EB 82. 12L	302	1224	1270	125	340	348

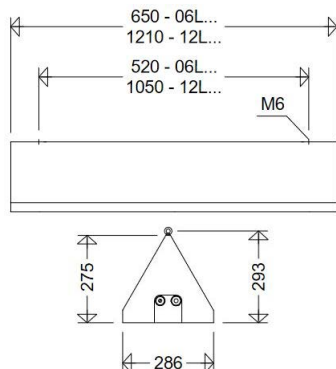

Mounting with RS 6

Frame for Recessed Installation

retrofit possible!

Light fittings of series 185... can be equipped with a frame even at a later stage.

Mounting by means of M5 bolts to the long sides of the housing (see drawing).

Article No.	Type	
18091 0020	EB 82. 06L	frame for narrow housing for 185 06L
18091 0021	EB 82. 12L	frame for narrow housing for 185 12L

Attention: When planning the opening for recess installation please allow additional clearance for the cable glands.

Attention: When installing in insulated ceiling and wall cut-outs, the maximum ambient temperature (Tmax) of the luminaire is reduced by 5 ° C!

Dust protection cover

retrofit possible!

Light fittings of series 185... series can be equipped (also retrofitted) with a dust protective cover to prevent dust deposits on the light fitting.

It is fastened to the long sides of the light fitting housing with M5 screws. M6 eyebolts (RS 6 P) are supplied for chain suspension.

Article No.	Type	
18093 0001	SSH 185 06	dust protection cover for 185 06L
18093 0002	SSH 185 12	dust protection cover for 185 12L

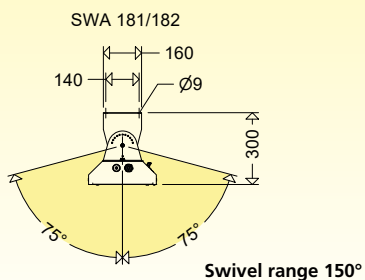
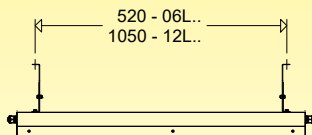

Swivel Arm Mounting System

retrofit possible!

Light fittings of series 185.. can be equipped with a swivel arm mounting system at any time.
The swivel arms are fixed to the suspen-

sion points at the upper side of the housing. Swivel range: $\pm 75^\circ$ (see dimensions in diagram).

Article No.	Type	
18092 0001	SWABF 181/182 P	for all lamp lengths, consisting of 2 swivel brackets and screws M8



Mounting material

Suspension brackets H8V P



Ceiling brackets 15A P



Wall/ceiling angles WDW 45 P



Note:

When using the carrier rail TRS 2000 the mounting accessories for TRS 2000 EX should be used (see section „Ex-light fittings“).

Accessories / Spare Parts

Article No.	Type	
Spare glasses		
82101 9001	ABD 821 06	cover, spare glass clear, for 185 06 ..., e821, nD822...
82101 9002	ABD 821 12	cover, spare glass clear, for 185 12 ..., e821, nD822...
18090 9027	ABD 185 06 PC SSK	cover, glass PC clear SSK, EPDM without longitudinal fixing rail, for 185 06 ... SSK
18090 9025	ABD 185 12 PC SSK	cover, glass PC clear SSK, EPDM without longitudinal fixing rail, for 185 12 ... SSK
Cable entries/cable glands		
25600 9000	2560	plastic cable gland M25 x 1,5
25720 9000	2572	plastic screw plug M25 x 1,5
Mounting material		
90019 0002	RS 6 P	2 eyebolts M6, galvanized steel
90001 0002	H8V P	2 suspension eyes, stainless steel
90000 0002	DS 15A P	2 ceiling brackets, hot galvanized steel
90032 0002	DS 15AV P	2 ceiling brackets, stainless steel
26000 0005	WDW 45 P	2 wall/ceiling angle 45°, painted steel
26000 0006	WDW 45 V P	2 wall/ceiling angle 45°, stainless steel (blasted)
26000 0011	WDW P	2 wall/ceiling angle, painted steel

SEGURO Vandal Proof LED Light Fitting Series 142...

Applications:

Indoors as well as protected and unprotected outdoor areas, Subways, railway stations, underground/metro stations, car parks, lavatories, schools, sport stadiums, stairways, bus-stops, prisons etc. (For damp and cold ambient conditions with low duty cycles and in the case of aggressive atmosphere, please contact us)

Design:

Housing: Flat, sturdy aluminium profile, powder-coated, RAL 9016 (traffic white). Concealed cable tray and mounting holes on the back, all-round silicone gasket.

Cover: Frosted polycarbonate, with die-cast aluminium end caps, concealed screw fixing, detachable and removable.

Reflector: Aluminium, white painted, with Zhaga-compliant LED modules.

Fasteners: With stainless steel safety screws M6 (TORX Tx30 with pin) counter-sunk in the end caps, the cover and end caps are screwed to the housing.

Electrical connection: 3-pole connection terminal

Cable entries: 2 x Ø 20mm with sealing plugs, concealed in the end cap on the face side, for in-out and continuous row wiring.

Mounting system: 4 holes Ø 8 mm, concealed. Please use screws Ø 6 mm for mounting.

Technical data:

LED: Linear modules 4,000 K, CRI > 80, service life $L_{90} > 50,000$ h at 25 °C ambient temperature, service life $L_{80} > 70,000$ h and $L_{70} > 100,000$ h at max. ambient temperature

ECG: 220-240 V, 50/60 Hz, overload and short-circuit protection

Ambient temperature: -20 °C bis +40 °C

Options:

- 2,200 K, 2,700 K, 3,000 K, 5,000 K, 6,500 K; light colours (822, 827, 830, 850, 865)
- coloured LEDs, for signal applications
- asymmetrical beam (A), e.g. for wall or corner mounting
- through-wiring (DV)
- cable entry, front side
- cover with anti-graffiti coating (AGC)
- special painting in RAL colours
- for higher ambient temperatures (H..)
- protection class II (SKII)

- seawater-resistant version
- for connection to a central power supply system (ZB)
- dimming function via DALI-2 interface, compatible with LIMAS Line wired Light Management System (DIMD)
- Corridor Mode with integrated motion sensor (SENS)
- Corridor Mode (DIMC)
- power reduction with control phase (LR)
- constant luminous flux function (CL)

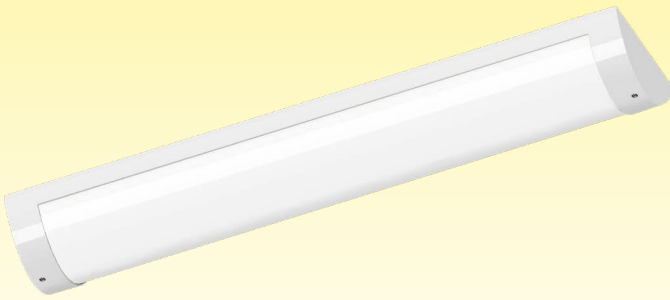

Note:

For applications in salty atmospheres, we do recommend enclosures in special design with KTL coating.

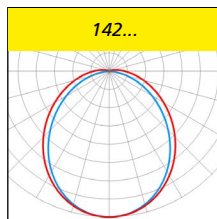
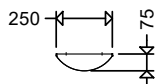
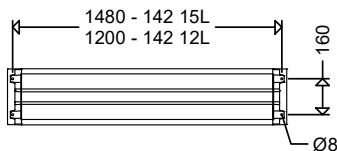
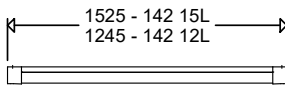

Product highlights:

- flat, robust design made of aluminium profile
- IPX9K-tested (high-pressure/steam jet cleaning)
- suitable for use in unprotected outdoor areas
- extremely impact-resistant PC tray, IK value in accordance with EN 50102 > 5 x IK10 (100 joules)
- safe function of the LED even in case of impacts or vibrations
- homogeneous illumination by using frosted covers, comfortable perception of light, brilliant glare limitation
- sustainable, control gear and LED-module replaceable by qualified personnel on-site
- future proof by using LED-modules according to Zhaga standard



Properties, limitations and details for controlling LED-light fittings:

See "Technical Supplement"

All data are correct at the time of printing. Actual technical data can be found under www.schuch.de.

Article no.	Type	Connected load [W]	Luminous flux [lm]	Luminous efficacy [lm/W]	Substitute for *	Weight [kg] without packing material
-------------	------	--------------------	--------------------	--------------------------	------------------	---

142 ...

IP66	IPX9K	5 x IK10				
------	-------	----------	--	--	--	--

14200 0003	142 12L22	17	2.550	150	1 x 36W	7,7
14200 0004	142 12L42	29	4.120	142	2 x 36W	7,7
14200 0007	142 12L60	39	5.490	140	2 x 58W	7,7
14200 0005	142 15L34	24	3.560	148	1 x 58W	9,4
14200 0006	142 15L60	42	6.050	144	2 x 58W	9,4

* The given information is for rough orientation only. In each individual case a lighting calculation is necessary.

Wall/ceiling angles WDW 45 P



Corner mounting with WDW 142 45 P



Accessories / Spare Parts

Article No.	Type	
14211 9000	EK 142	End cap, powder-coated aluminium RAL 9016
14211 9002	ABD 142 12	cover, frosted PC diffuser, for 142 12 ...
14211 9003	ABD 142 15	cover, frosted PC diffuser, for 142 15 ...
90063 9000	2511	blanking plug M20
90045 9007	WDW 142 45 P	2 wall/ceiling angle 45°, steel painted to RAL 9016 for corner mounting



Aluminium Carrier Rails for Continuous Row Installation

Series TRS 2000... and AL...

Application:

For rows of light fittings suspended from the ceiling, allowing an easy installation and assembly.

Design:

Aluminium profiled carrier rails (AL/TRS 2000)

Lengths: 2, 3 or 5 m. Additional covering strip (TRS A) for series TRS.

Mounting accessories:

For each length of a light fitting only one suspension point is required.

Connection brackets (TRS V) - to be ordered separately - allow joining the individual rails up to any length wanted. The carrier rails can either be mounted

directly to the ceiling by means of the ceiling brackets (183 A / TRS D) or they can be suspended from the ceiling by means of the hook (183 H / TRS S) in combination with the chain (KP 40) (max. distance of mounting rail elements 2.5 m). Perlon pendulums are not suitable for this purpose.

2 or 3 devices (183 L / TRS L) serve for mounting a light fitting to the rail. The suspension devices 183 A / TRS D and 183 H / TRS S as well as the devices 183 L / TRS L are movable in the longitudinal direction of the rails.

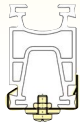
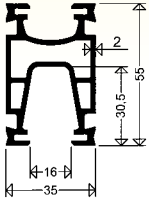

TRS 2000 H

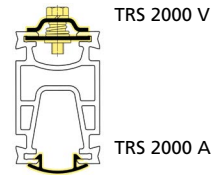

TRS 2000 V



TRS 2000 A

TRS 2000 A

TRS 2000 A



TRS 2000 S

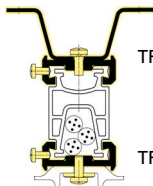

TRS 2000 D

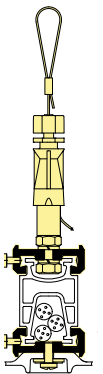

TRS 2000 L

TRS 2000 L

TRS 2000 FF

TRS 2000 L

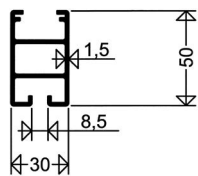

183 H

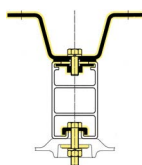

183 A

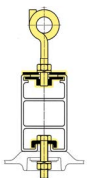

183 L



183 L

TRS 2000...

aluminium carrier rails

Product highlights:

- universal quick-action mounting system for explosion- and weather-proof light fittings.
- easy to install. (Fasten the suspension devices to the light fitting, push the light fitting with its suspension devices into the carrier rail profile - ready.)
- high carrying force thanks to a new profile structure
- possibility to insert the mains cable into the cable channel
- cover strips to protect against dirt deposit.

Article no.	Type	Product	Weight ca. [kg]
90260 0001	TRS 2000 2 m	Alu-rail 2 m long	3,03
90260 0002	TRS 2000 3 m	Alu-rail 3 m long	4,55
90260 0003	TRS 2000 5 m	Alu-rail 5 m long	7,58
90265 0005	TRS 2000 A 1 m	covering strip, 1 m long	0,04
90265 0006	TRS 2000 A 2 m	covering strip, 2 m long	0,07

Mounting Devices

Article no.	Type	Product
90265 0004	TRS 2000 V	stainless steel device (profile) for rail connection
90265 0002	TRS 2000 D	stainless steel ceiling bracket
90022 0001	KP 40	chain 1 m long with 2 eyelets for fastening and length compensation
90265 0001	TRS 2000 S	stainless steel swing hook for chain
90265 0003	TRS 2000 L	luminaire suspension device
90265 0010	TRS 2000 H	stainless steel luminaire mounting, for later installation
90265 0011	TRS 2000 FF	FastFix quick assembly system, steel, galvanised, with 2 m steel cable, rope length infinitely variable

Please note: For mounting the sheet steel light fittings (such as series 185...) please use the mounting accessories of the ex-proof light fittings.

AL...

aluminium carrier rails

Article no.	Type	Product	Weight ca. [kg]
90005 0001	AL 2M	Alu-rail 2 m long	1,6

Mounting Devices

Article no.	Type	Product
90265 0004	TRS 2000 V	stainless steel device for rail connection
90185 0001	183 A	stainless steel ceiling bracket for ceiling mounting of the carrier rail
90022 0001	KP 40	chain 1 m long with 2 eyelets for fastening and length compensation
90049 0001	183 H	stainless steel hook for chain pendulum
90050 0001	183 L	stainless steel luminaire mounting system complete



Sheet steel Carrier Rails for Continuous Row Installation Series TRS 1000

Application:

For rows of polyester dust-/waterproof light fittings suspended from the ceiling, allowing an easy installation an assembly.

Design:

Profile carrier rails made from sheet steel, galvanized and painted in white on the outside

Lengths:

3065 mm (TRS 1000/2) and

4595 mm (TRS 1000/3)

Additional covering strip (TRS 1000 A)

1538 mm

Mounting accessories:

Connection brackets (TRS 1000 V) – to be ordered separately – allows joining the

individual rails up to any length required.

The carrier rails can either be mounted directly to the ceiling by means of the ceiling hanger (TRS 1000 S) or they can be suspended from the ceiling with chain suspension (KP 40), (max. distance of mounting rail elements 2 m). 2 or 3 devices (TRS 1000 L P) serve for mounting a light fitting to the rail. The carrier rail can be covered with a covering strip (TRS 1000 A) and they can also be closed at the ends with caps (TRS 1000 E P).

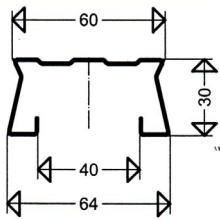

TRS 1000...

Sheet steel carrier rail systems

Article no.	Type	Product
90261 0001	TRS 1000 /2	sheet steel carrier rail 3,065 mm long
90261 0002	TRS 1000 /3	sheet steel carrier rail 4,595 mm long

Mounting equipment

Article no.	Type	Product
90264 0001	TRS 1000 V	rail connector
90264 0002	TRS 1000 S	rail suspension device for direct mounting or chain pendant suspension
90022 0001	KP 40	chain 1 m long with 2 eyelets for length compensation
90264 0008	TRS 1000 L P	luminaire mounting device (1 pair)
90264 0004	TRS 1000 A	covering strip for the rail 1,538 mm
90264 0007	TRS 1000 E P	end cap for the rail (1 pair)

TRS 1000 S



TRS 1000 L

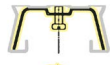

TRS 1000 V



TRS 1000 E



TRS 1000 A

Note:

Most of our light fittings have got two entries at one end of the housing for looping the mains cable. **Thus, the classical through-wiring system is no longer required in many cases.**

The maximum allowed ambient temperature will be reduced by up to 5 °C if Through-Wiring operating current exceeds 8A (5 x 1,5 mm²) respectively 10 A (5 x 2,5 mm²).

Through-Wiring Systems

One fixed multipole terminal at each end of the housing.
Heat-resistant PVC or silicone cables fixed to the housing with clips.

Through-wiring systems:

1,5 mm² up to 10 A max.
2,5 mm² up to max. 16 A max.

In case of loads >8A the maximum permissible ambient temperature is reduced by 5 °C.
Light fittings with electronic ballasts do have a high inrush current, hence the maximum permissible number of waterproof LED light fittings with through-wiring system per circuit breaker must be observed.
(see <http://www.schuch.de/en/service/photometric-files>)

For light fittings in continuous row installation we do recommend factory-fitted through-wiring systems.

Through-Wiring Systems Installed in the SCHUCH Factory

If through-wiring systems are wanted, we supply our dustproof/waterproof light fittings with **standard through-wiring systems: 5 x 1,5 mm² PVC.**

Other conductor cross-sections and numbers of cores as well as through-wiring made of silicone are available on request.

For retrofitting our retrofit kits must be used.

Through-wiring systems for subsequent installation:

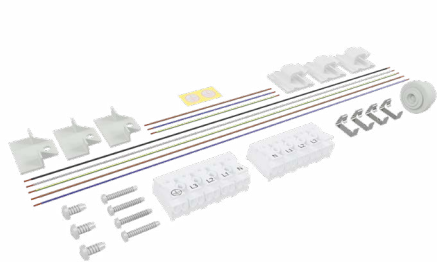

Article no.	Type	Product
Universal retrofit kits, suitable for 161PX...		
11831 0046	DV/NS P 5 x 1,5 161PX	5 x 1,5 mm ² PVC, 105 °C
11831 0047	DV/NS P 5 x 2,5 161PX	5 x 2,5 mm ² PVC, 105 °C
Universal retrofit kits, suitable for 161/162/163/164...		
11831 0013	DV/NS P 5 x 1,5	5 x 1,5 mm ² PVC, 105 °C
11831 0022	DV/NS P 5 x 2,5	5 x 2,5 mm ² PVC, 105 °C
11831 0014	DV/NS S 5 x 1,5	5 x 1,5 mm ² Silicone, 150 °C
11831 0024	DV/NS S 5 x 2,5	5 x 2,5 mm ² Silicone, 150 °C
Universal retrofit kits, suitable for 144...		
11831 0030	DV/NS P 5 x 2,5 144.	5 x 2,5 mm ² PVC, 105 °C
11831 0031	DV/NS S 5 x 2,5 144.	5 x 2,5 mm ² Silicone, 150 °C
Universal retrofit kits, suitable for 167... G2 LUXANO		
11831 0040	DV/NS P 3 x 1,5 167.G2	3 x 1,5 mm ² PVC, 105 °C
11831 0041	DV/NS P 3 x 2,5 167.G2	3 x 2,5 mm ² PVC, 105 °C
11831 0042	DV/NS P 5 x 1,5 167.G2	5 x 1,5 mm ² PVC, 105 °C
11831 0043	DV/NS P 5 x 2,5 167.G2	5 x 2,5 mm ² PVC, 105 °C
Retrofit kits for simplified through-wiring by customer with NYM cable up to 2,5 mm², can be used for 167... G2 LUXANO		
11831 0044	DV/NS NYM3 167.G2	up to 3 x 2,5 mm ²
11831 0045	DV/NS NYM5 167.G2	up to 5 x 2,5 mm ²



High Bay Fittings

Perfect solutions for various requirements

The company has produced light fittings for applications in workshops, industrial, processing and storage areas even in the beginning of its history. When high-pressure lamps appeared, this product line had become one of the main segments in the whole range. As in other manufacturing areas, SCHUCH design engineers covered more and more application fields with severe operating conditions. As a result, along with standard series, many new special versions have been developed over the time. Such special versions have turned into industry solutions due to which SCHUCH is known far beyond Germany by today.

Even in the most severe conditions, such as chlorine electrolysis plants, galvanizing plants or compost systems, SCHUCH light fittings demonstrate reliable operation and withstand the most aggressive environments.

New industrial LED light fittings feature, in particular, excellent temperature control, which is the basic condition of a long service life and one of the most important quality factors for a LED light fitting.

STANDARD OR CUSTOMIZED SOLUTIONS? SCHUCH OFFERS BOTH.

1926

Workplace lights, ceiling and pendant lights up to 1,000 W as well as deep, semi-deep and diagonal spotlights up to 2,000 W for illuminating workshops are part of the product range early in the company's history.

1949

Production of the first industrial reflector-light fitting for mercury vapor lamps.

1975

Production of the first industrial high bay light fitting made of fiberglass-reinforced polyester for application in very aggressive environment, such as in galvanizing plants, compost systems, steeping plants, etc.

1998

Application of inductive lamp systems with a minimum service life of 60,000 hours. This allowed using high bay light fittings in electrical high-current and strong-magnetic-field applications, such as chlorine electrolysis plants.

2001

Introduction of the first high bay light fitting having a specific triangular shape, which is designed for dust-loaded and polluted environments with a high ambient temperature and high fire hazard.

2003

The range of high bay light fittings has been extended significantly by adding special versions for food industry, blast rooms, applications with high ambient temperatures up to +90 °C and many others.



High Bay Fittings

Product	Series	Page
Light management		
LIMAS Air CASA		134
Radio-based light management system for industrial indoor areas		
LIMAS Line BASIC / PRO		135
Wired light management		
with 1 point mounting		
TRIANO Generation 3	3401/3402... G3	136-140
TRIANO L Generation 3	3403... G3	141-142
TRIANO XL Generation 3	3405... G3	143-144
TRIANO disc	3410/3420/3430...	145-146
with 2 point mounting		
DUEVO	3301/3302...	147-150
• variable setting of luminous fluxes	3301/02... VARIO	149
• for food industry areas	... IFS	149
• for cattle and horse stables	... ER	150
• for pig stalls	... LW	150
• for swimming pools	... SBL	150
DUEVO XL	3305...	151-152
• for food industry areas	... IFS	152
AREALO 2	7955...	153-156
• for food industry areas	... IFS	155
• Ready for Light Management Systems	... RFL	155
• for swimming pools	... SBL	156
• for galvanising plants	... V	156
Floodlights		
<i>for swimming pools</i>		
FOCO	7600... SBL	157-158
FOCO L	7700... SBL	157-158
FOCO XL	7800... SBL	157-158
<i>for sand / glass blasting areas and cabins</i>		
FOCO L	7700... SSK	159-160
FOCO XL	7800... SSK	159-160

LED TECHNOLOGY

2008

LED reflector light fittings are the first LED high bay light fittings in the product program.

2013

SCHUCH introduces the **DUEVO**. The first exclusively for LED applications developed LED High bay light fitting with 2 point mounting.

2015

TRIANO Series for 1-point suspension mounting has been added to the range of high bay LED light fittings.

2017/2019

The range is continuously expanded. **TRIANO L and XL** and **DUEVO XL** for halls with large mounting heights follow.

2019/20

SCHUH intensely investigates the influence of harmful gases on LED lights. The **RESISTANT light fitting range** develops from this.

2020/2021

Introduction of the new **TRIANO disc** high-bays.

2022/2023

With the **LIMAS Air and LIMAS Line** Light Management Systems, all SCHUCH high-bay light fittings become smart in no time at all. Extremely simple, fast, tool-free and without additional installation effort.

2025

Standard versions of the **TRIANO disc** will become part of the new **BestSelect** program, a selection of proven SCHUCH light fittings for everyday use.

2025/26

We complete our range of indoor light fittings with light fittings for swimming pools. Proven series are modified and optimised. This has resulted in the **AREALO 2** indoor light fitting, and **TRIANO**s are now even more compact, lighter and easier to install in their third generation.















Whether replacing an existing system or installing a new one, with the LIMAS Air light management system, you can now make your light system smart in no time at all and take it to a whole new level. Extremely simple, fast, and without any additional installation effort. Commissioning is child's play and extremely convenient thanks to the free smartphone app. Based on CASAMBI® wireless technology, you can control your light system with low power consumption and a long range, with the participants connected to each other via a self-organizing mesh network and communicating with each other. Sensors specially developed for industrial use allow up to 250 lights in a system to be controlled and regulated. From simple switching and dimming to complex lighting scenes, everything can be implemented in the simplest possible way.

Depending on the series and design of the high bay light, LIMAS Air can be used in different ways:

- with the help of the LIMAS Air radio module, which is connected to the luminaire via a FastConnect quick-connect plug, turning any DIMD high bay luminaire from SCHUCH into a smart luminaire.
- with luminaires in RFL design, which are already prepared for the addition of Light Management components thanks to the Zhaga socket in the housing.



System accessories

Type	Art.-No.		
LACA BM/DS IR10	90547 9014	CASAMBI® motion and light sensor for mounting heights of 2.0 – 10.0 m and a maximum detection range of 24,0 m in diameter	
LACA BM/DS IR16	90547 9013	CASAMBI® motion and light sensor for mounting heights of 5.0 – 16.0 m and a maximum detection range of 19.0 m x 30.0 m	
LACA BM/DS IR20	90547 9007	CASAMBI® motion and light sensor for mounting heights up to 20.0 m and a maximum detection range of 5.0 m in diameter	
LACA BM/DS IR3	90547 9008	CASAMBI® motion and light sensor for mounting heights up to 2.2 m and a maximum detection range of 5.0 m in diameter	
LACA FM DALI PS120	90547 9010	CASAMBI® radio module with DALI power supply and broadcast control for up to 60 ECGs (total current 120 mA). Power supply 230 V	
LACA FM FC	90547 9001	CASAMBI® radio module with FastConnect quick-connector for controlling DIMD luminaires	
LACA FM FC MK1	90547 9002	CASAMBI® radio module with FastConnect quick-connector for controlling DIMD luminaires and 1.0 m cable	
LACA TAST4 AP	90547 9011	Battery-free, 4-button CASAMBI® radio switch. Actuating the switch generates the energy required to power the switch electronics	
LACA TASTIF4 UP	90547 9009	CASAMBI® push-button interface for connecting up to 4 volt-free push-button inputs. Designed for installation in a flush-mounted wall box	
RFL LACA FM DS	90546 9013	CASAMBI® radio module with light sensor for RFL sockets	



Wired light management

With LIMAS Line, you can create an easy-to-use wired light management system with the help of DIMD luminaire versions and additional system accessories. It creates ideal conditions for flexible use of space, focusing in particular on people's different needs and reducing operating costs at the same time.

LIMAS Line BASIC Wired light management system for small DALI projects

LIMAS Line BASIC enables fully automated, dynamic light in conjunction with the corresponding sensors. Configuration is carried out using a smart end device (Android or iOS) via a wireless connection. This only requires a free app with which the room to be illuminated can be recreated and equipped and configured with luminaires, sensors and push-buttons.

For further details and properties, see the chapter on light management systems.

LIMAS Line PRO Wired light management system with emergency lighting monitoring / building management integration

LIMAS Line PRO offers extended options and additional functions. In addition to DIMD luminaires, all self-contained emergency luminaires (MA-Z) in the SCHUCH portfolio can also be controlled and monitored. Configuration and control are carried out via PC without additional software - a browser is sufficient. The connection between the PC and LIMAS Line PRO can be realised either via an existing network or by establishing a peer-to-peer connection. An Internet connection is not required. For further details and properties, see the chapter on light management systems.

System accessories

Type	Art.-No.		
LLPO AKTOR 4X10	90545 0041	DALI-2 actuator with 4 volt-free outputs (max. 10 A). Suitable for signaling test states and system statuses of self-contained emergency luminaires	
LL BM/DS HF4	90545 0040	High-frequency DALI-2 motion sensor with integrated light sensor for mounting heights of 2.0 – 4.0 m and a maximum detection range of 8.0 m in diameter	
LL BM/DS IR14	90545 0036	Infrared DALI-2 motion sensor with integrated light sensor for mounting heights of 4.0 - 14.0 m	
LL BM/DS IR16	90545 0037	Infrared DALI-2 motion sensor with integrated light sensor for mounting heights of 4.0 - 16.0 m	
LL BM/DS IR3	90545 0038	Infrared DALI-2 motion sensor with integrated light sensor for vertical wall mounting, suitable for installation heights of 1.8 – 2.5 m	
LL BM/DS IR4	90545 0035	Infrared DALI-2 motion sensor with integrated light sensor for mounting heights of 2.5 – 4.0 m	
LL BM/DS IR5	90545 0039	Infrared DALI-2 motion sensor with integrated light sensor for mounting heights of 2.5 – 5.0 m and a maximum detection range of 6.0 m x 23.0 m	
LL DALI PS240	90545 0016	DALI bus power supply with up to 240 mA maximum output current	
LL TASTIF4 UP	90545 0015	DALI-2 push-button interface for connecting up to 4 volt-free push-button inputs. Designed for installation in a flush-mounted wall box	
LL XR DS4	90545 0045	DALI-2 light sensor in encapsulated housing for areas exposed to harmful gases and mounting heights of 2.0 to 4.0 m	
LLBC CON	90545 0005	DALI-2 controller for controlling up to 64 devices	
LLPO CON	90545 0031	DALI-2 controller for controlling up to 192 devices across 3 DALI buses. Monitoring of self-contained emergency luminaires possible	

High Bay
Fittings

NEW

TRIANO 3rd Generation LED High Bay Fitting Series 3401/3402... G3



Applications:

Production areas and warehouses, maintenance and assembly shops, cool storage facilities, walkways in rack areas, hardware stores etc.

All case parts powder coated in DB 702, smooth, matt.

Light distribution: Without optics wide beam, with optics wide (B), narrow-wide (TB) or narrow beam (T).

Design:

LED-segment: Robust three-part cast aluminium housing with cooling fins, LED-modules and flat safety glasses (IK09), versions B, TB or T with PC-cover and incorporated optics.

Connection: 5-pole quick connection from the outside.

Mounting: 1-point suspension, eyelet included.

ECC-housing: Cast aluminium

Technical Data:

LED module: 4,000 K or 5,000 K, CRI > 80, service life L_{90} > 50,000 h at 25 °C ambient temperature, service life L_{70} > 100,000h at max. ambient temperature
ECCG: 220-240 V, 50/60 Hz, Surge voltage resistance 4 kV, overload and short circuit protection.

Ambient temperature: -25 °C up to .. °C (see article tables)

Options:

- according to 'International Featured Standard Food' (IFS), with PC cover, without optics
- for higher ambient temperatures (H70), up to +70 °C
- silicone-free
- for connection to central emergency supply systems (ZB)
- dimming function via DALI2 interface, compatible with LIMAS Line wired Light Management System (DIMD)
- constant luminous flux function (CL)
- radio-controlled Light Management System for industrial indoor areas (LIMAS Air)

General product highlights:

- long-lasting, corrosion-resistant die-cast aluminium housing
- excellent thermal management through cooling fin structure and direct connection of the LED modules to the housing. Huge heat sink, excellent heat dissipation, excellent convection.
- uniform illumination due to the „Multi-Layer Technology“
- high system service life of up to 100,000 h, saves premature replacement and conserves valuable resources
- high energy cost savings thanks to low connected load and high efficiency
- fast mounting and commissioning due to 1-point suspension and external quick connection
- sustainable, control gear and LED-module replaceable by qualified personnel on-site

3401... G3

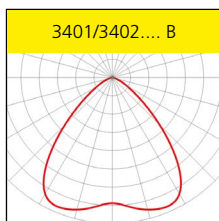
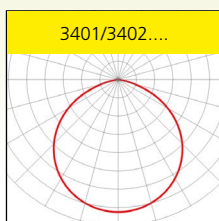
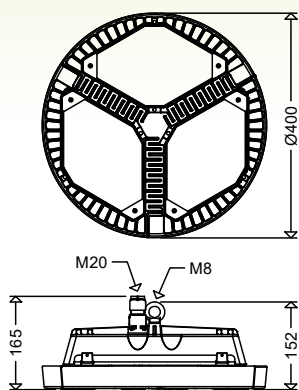

3402... G3

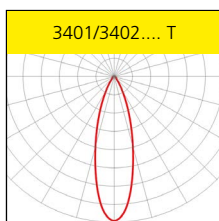
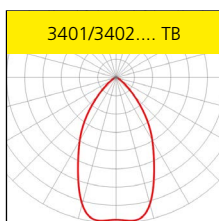
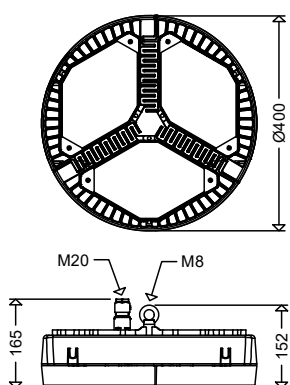

! Properties, limitations and details for controlling LED-light fittings:

■ See "Technical Supplement"

All data are correct at the time of printing. Actual technical data can be found under www.schuch.de.



The versions with optics (B, TB and T) are suitable for use in food areas (IFS / HACCP).

Article no.	Type	dimmable	Wide beam	Narrow wide beam	Narrow beam	Tmax [°C]	Weight [kg] (without packing material)	Connected load [W]	Luminous flux [lm]	Light output [lm/W]	Substitute for *
-------------	------	----------	-----------	------------------	-------------	-----------	--	--------------------	--------------------	---------------------	------------------



3401... G3

colour temperature 4.000K (light colour 840)

34017 0001	3401 L100 G3		•		
34017 0002	3401 L100B G3		•		
34017 0003	3401 L100TB G3			•	
34017 0004	3401 L100 G3 DIMD	•	•		
34017 0005	3401 L100B G3 DIMD	•	•		
34017 0006	3401 L100TB G3 DIMD	•		•	

55	6,3	61	10.000	164	HME250
----	-----	----	--------	-----	--------

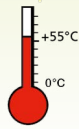

colour temperature 5.000K (light colour 850)

34017 0013	3401 L100 G3 850		•		
34017 0014	3401 L100B G3 850		•		
34017 0015	3401 L100TB G3 850			•	
34017 0016	3401 L100 G3 DIMD 850	•	•		
34017 0017	3401 L100B G3 DIMD 850	•	•		
34017 0018	3401 L100TB G3 DIMD 850	•		•	

55	6,3	61	10.000	164	HME250
----	-----	----	--------	-----	--------

colour temperature 4.000K (light colour 840)

34017 0007	3401 L200 G3		•		
34017 0008	3401 L200B G3		•		
34017 0009	3401 L200TB G3			•	
34017 0010	3401 L200 G3 DIMD	•	•		
34017 0011	3401 L200B G3 DIMD	•	•		
34017 0012	3401 L200TB G3 DIMD	•		•	

50	6,3	123	20.000	163	HIT 250, HME 400, HIE 400 (HS-VG)
----	-----	-----	--------	-----	-----------------------------------

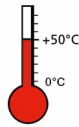

colour temperature 5.000K (light colour 850)

34017 0019	3401 L200 G3 850		•		
34017 0020	3401 L200B G3 850		•		
34017 0021	3401 L200TB G3 850			•	
34017 0022	3401 L200 G3 DIMD 850	•	•		
34017 0023	3401 L200B G3 DIMD 850	•	•		
34017 0024	3401 L200TB G3 DIMD 850	•		•	

50	6,3	123	20.000	163	HIT 250, HME 400, HIE 400 (HS-VG)
----	-----	-----	--------	-----	-----------------------------------

* The given information is for rough orientation only. In each individual case a lighting calculation is necessary. (VG = ballast)

The versions with optics (B, TB and T) are suitable for use in food areas (IFS / HACCP).

Article no.	Type	dimmmable	Wide beam	Narrow wide beam	Narrow beam	Tmax [°C]	Weight [kg] (without packing material)	Connected load [W]	Luminous flux [lm]	Light output [lm/W]	Substitute for *
-------------	------	-----------	-----------	------------------	-------------	-----------	--	--------------------	--------------------	---------------------	------------------

3402... G3



colour temperature 4.000K (light colour 840)

34012 0023	3402 L100 G3		•		
34012 0025	3402 L100B G3		•		
34012 0027	3402 L100TB G3			•	
34012 0024	3402 L100 G3 DIMD	•	•		
34012 0026	3402 L100B G3 DIMD	•	•		
34012 0028	3402 L100TB G3 DIMD	•		•	

65	6,5	61	10.000	164	HME250
----	-----	----	--------	-----	--------

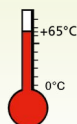

colour temperature 5.000K (light colour 850)

34012 0001	3402 L100 G3 850		•		
34012 0003	3402 L100B G3 850		•		
34012 0005	3402 L100TB G3 850			•	
34012 0002	3402 L100 G3 DIMD 850	•	•		
34012 0004	3402 L100B G3 DIMD 850	•	•		
34012 0006	3402 L100TB G3 DIMD 850	•		•	

65	6,5	61	10.000	164	HME250
----	-----	----	--------	-----	--------

colour temperature 4.000K (light colour 840)

34012 0029	3402 L200 G3		•		
34012 0031	3402 L200B G3		•		
34012 0033	3402 L200TB G3			•	
34012 0035	3402 L200T G3				•
34012 0030	3402 L200 G3 DIMD	•	•		
34012 0032	3402 L200B G3 DIMD	•	•		
34012 0034	3402 L200TB G3 DIMD	•		•	
34012 0036	3402 L200T G3 DIMD	•			•

60	6,5	123	20.000	163	HIT250, HME400, HIE400 (HS-VG)
----	-----	-----	--------	-----	--------------------------------

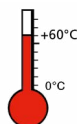

colour temperature 5.000K (light colour 850)

34012 0007	3402 L200 G3 850		•		
34012 0009	3402 L200B G3 850		•		
34012 0011	3402 L200TB G3 850			•	
34012 0013	3402 L200T G3 850				•
34012 0008	3402 L200 G3 DIMD 850	•	•		
34012 0010	3402 L200B G3 DIMD 850	•	•		
34012 0012	3402 L200TB G3 DIMD 850	•		•	
34012 0014	3402 L200T G3 DIMD 850	•			•

60	6,5	123	20.000	163	HIT250, HME400, HIE400 (HS-VG)
----	-----	-----	--------	-----	--------------------------------

colour temperature 4.000K (light colour 840)

34012 0037	3402 L300 G3		•		
34012 0039	3402 L300B G3		•		
34012 0041	3402 L300TB G3			•	
34012 0043	3402 L300T G3				•
34012 0038	3402 L300 G3 DIMD	•	•		
34012 0040	3402 L300B G3 DIMD	•	•		
34012 0042	3402 L300TB G3 DIMD	•		•	
34012 0044	3402 L300T G3 DIMD	•			•

50	6,7	190	30.000	158	HIE400 (HS-VG), HIT400
----	-----	-----	--------	-----	------------------------

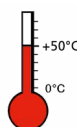

colour temperature 5.000K (light colour 850)

34012 0015	3402 L300 G3 850		•		
34012 0017	3402 L300B G3 850		•		
34012 0019	3402 L300TB G3 850			•	
34012 0021	3402 L300T G3 850				•
34012 0016	3402 L300 G3 DIMD 850	•	•		
34012 0018	3402 L300B G3 DIMD 850	•	•		
34012 0020	3402 L300TB G3 DIMD 850	•		•	
34012 0022	3402 L300T G3 DIMD 850	•			•

50	6,7	190	30.000	158	HIE400 (HS-VG), HIT400
----	-----	-----	--------	-----	------------------------

* The given information is for rough orientation only. In each individual case a lighting calculation is necessary. (VG = ballast)

Article no.	Type	Wide beam	Narrow wide beam	Tmax [°C]	Weight [kg] (without packing material)	Connected load [W]	Luminous flux [lm] ¹⁾	Light output [lm/W]	Substitute for *
-------------	------	-----------	------------------	-----------	--	--------------------	----------------------------------	---------------------	------------------

3402... G3 VARIO



Design:

Same as type 3402... G3 but: With a switch for for variable adjustment of the luminous flux in the luminaire. The connected load will change depending on the setting of the luminous flux.

Product highlights of the VARIO version:

- universally usable due to variable setting of the luminous flux, depending on the requirement
- simple and quick adjustment on-site without tools
- can be changed at any time (e.g. change of use of the premises with new requirements in regard to the level of illumination)



colour temperature 4.000K (light colour 840)

34014 0001	3402 L200 G3 VARIO	•	60	6,5	70 - 123	11.430 - 20.000	163	HME250 - HIT250, HME400, HIE400 (HI-VG)
34014 0002	3402 L200B G3 VARIO	•						
34014 0003	3402 L200TB G3 VARIO	•						

colour temperature 5.000K (light colour 850)

34014 0007	3402 L200 G3 VARIO 850	•	60	6,5	70 - 123	11.430 - 20.000	163	HME250 - HIT250, HME400, HIE400 (HI-VG)
34014 0008	3402 L200B G3 VARIO 850	•						
34014 0009	3402 L200TB G3 VARIO 850	•						

colour temperature 4.000K (light colour 840)

34014 0004	3402 L300 G3 VARIO	•	50	6,7	109 - 190	17.140 - 30.000	158	HIT250, HME400, HIE400 (HI-VG) HIE400 (HS-VG), HIT400
34014 0005	3402 L300B G3 VARIO	•						
34014 0006	3402 L300TB G3 VARIO	•						

colour temperature 5.000K (light colour 850)

34014 0010	3402 L300 G3 VARIO 850	•	50	6,7	109 - 190	17.140 - 30.000	158	HIT250, HME400, HIE400 (HI-VG) HIE400 (HS-VG), HIT400
34014 0011	3402 L300B G3 VARIO 850	•						
34014 0012	3402 L300TB G3 VARIO 850	•						

Factory setting L200: 123 W; replaces approx. ca. HIT 250
 Factory setting L300: 190 W; replaces approx. HIT 400

1) possible setting range



Foto: Rosoriginal, Alphen aan den Rijn

Article no.	Type	Wide beam	Narrow wide beam	Tmax [°C]	Weight [kg] (without packing material)	Connected load [W]	Luminous flux [lm]	Light output [lm/W]	Substitute for *
-------------	------	-----------	------------------	-----------	--	--------------------	--------------------	---------------------	------------------

NEW

RFL - Ready for Light Management Systems

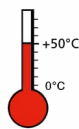
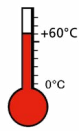
Design:

Same as standard version, but prepared for the subsequent use of a Light Management System. Integrated sockets allows retrofitting of Light Management components without tools.

Product highlights:

- standardised Zhaga Book 18 compliant sockets with D4i control gear
- subsequent use of a light management system possible at any time
- tool-free, quick assembly of the Light Management System accessories



Available on request with ESG cover and T-optics.



3402... G3 RFLou

with a socket on the top and bottom side of the luminaire

colour temperature 4.000K (light colour 840)

34013 0046	3402 L100B G3 RFLSOU	•	65	6,5	61	10.000	164	HME250
34013 0047	3402 L100TB G3 RFLSOU	•						

colour temperature 5.000K (light colour 850)

34013 0057	3402 L100B G3 850 RFLSOU	•	65	6,5	61	10.000	164	HME250
34013 0058	3402 L100TB G3 850 RFLSOU	•						

colour temperature 4.000K (light colour 840)

34013 0049	3402 L200B G3 RFLSOU	•	60	6,5	123	20.000	163	HIT250, HME400, HIE400 (HS-VG)
34013 0050	3402 L200TB G3 RFLSOU	•						

colour temperature 5.000K (light colour 850)

34013 0060	3402 L200B G3 850 RFLSOU	•	60	6,5	123	20.000	163	HIT250, HME400, HIE400 (HS-VG)
34013 0061	3402 L200TB G3 850 RFLSOU	•						

colour temperature 4.000K (light colour 840)

34013 0053	3402 L300B G3 RFLSOU	•	50	6,7	190	30.000	158	HIE400 (HS-VG), HIT400
34013 0054	3402 L300TB G3 RFLSOU	•						

colour temperature 5.000K (light colour 850)

34013 0064	3402 L300B G3 850 RFLSOU	•	50	6,7	190	30.000	158	HIE400 (HS-VG), HIT400
34013 0065	3402 L300TB G3 850 RFLSOU	•						

* The given information is for rough orientation only. In each individual case a lighting calculation is necessary. (VG = ballast)

System accessories

Article No.	Type	
90547 9011	LACA TAST4 AP	Battery-free, 4-button CASAMBI® radio switch. Actuating the switch generates the energy required to power the switch electronics
90547 9009	LACA TASTIF4 UP	CASAMBI® push-button interface for connecting up to 4 volt-free push-button inputs. Designed for installation in a flush-mounted wall box
90546 9013	RFL LACA FM DS	CASAMBI® radio module with light sensor for RFL sockets

Accessories / Spare Parts

Article no.	Type	
34011 9001	ABD TRIANO ESGW	cover, clear safety glass pane (for 1 LED module), for 3401..., 3402..., 3403..., 3410..., 3420..., 3430...
34011 9003	ABD TRIANO PRA PMMA	cover, clear PMMA disc with outer prisms (for 1 LED module), for 3401..., 3402..., 3403..., 3410..., 3420..., 3430...
34011 9002	ABD TRIANO PC	cover, clear PC IFS disc (for 1 LED module), for 3401..., 3402..., 3403..., 3410..., 3420..., 3430...
34011 9004	ABD TRIANO B PC	cover, clear PC disc, wide beam (for 1 LED module), with optics, for 3401..., 3402..., 3403..., 3410..., 3420..., 3430...
34011 9005	ABD TRIANO TB PC	cover, clear PC disc, narrow-beam wide distribution (for 1 LED module), with optics, for 3401..., 3402..., 3403..., 3410..., 3420..., 3430...
34011 9006	ABD TRIANO T PC	cover, clear PC disc, narrow beam (for 1 LED module), with optics, for 3401..., 3402..., 3403..., 3410..., 3420..., 3430...
34011 9013	SAS 3401 G3	cover, shield galvanized steel, painted as a dirt shield retrofitting, for 3401... G3
34011 9012	SAS 3402 G3	cover, shield galvanized steel, painted as a dirt shield retrofitting, for 3402... G3

NEW

TRIANO L Generation 3 LED High Bay Fitting Series 3403... G3

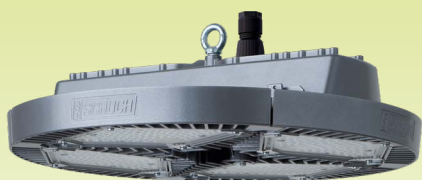

Applications:

Production areas and warehouses, maintenance and assembly shops, cool storage facilities, walkways in rack areas, hardware stores etc.

Light distribution: Without optics wide beam, with optics wide (B), narrow-wide (TB) or narrow beam (T).

Connection: 5-pole quick connection from the outside.

Mounting: 1-point suspension, eyelet included.

Design:

LED-segment: Robust four-part cast aluminium housing with cooling fins, LED-modules and flat safety glasses (IK09), versions B, TB or T with PC-cover and incorporated optics.

ECG-housing: Cast aluminium

All case parts powder coated in DB 702, smooth, matt.

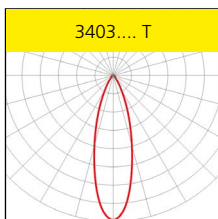
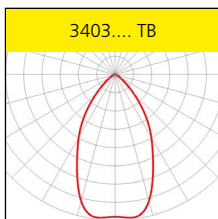
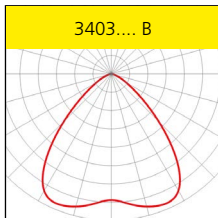
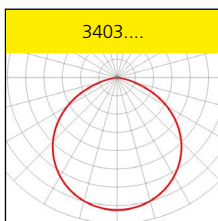
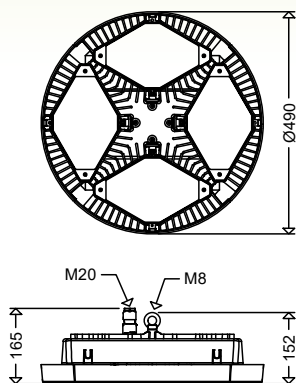

Technical Data:

LED module: 4,000 K or 5,000 K, CRI > 80, service life $L_{90} > 50,000$ h at 25 °C ambient temperature, service life $L_{70} > 100,000$ h at max. ambient temperature
ECG: 220-240 V, 50/60 Hz, Surge voltage resistance 4 kV, overload and short circuit protection.

Ambient temperature: -25 °C up to .. °C (see article tables)

Options:

- according to 'International Featured Standard Food' (IFS), with PC cover, without optics
- for higher ambient temperatures (+70 °C)
- silicone-free
- for connection to central emergency supply systems (ZB)
- Ready for Lightmanagement System (RFL)
- dimming function via DALI2 interface, compatible with LIMAS Line wired Light Management System (DIMD)
- power reduction with control phase (LR)
- constant luminous flux function (CL)
- radio-controlled Light Management System for industrial indoor areas (LIMAS Air)

Product highlights:

- long-lasting, corrosion-resistant die-cast aluminium housing
- excellent thermal management through cooling fin structure and direct connection of the LED modules to the housing. Huge heat sink, excellent heat dissipation, excellent convection.
- uniform illumination due to the „Multi-Layer Technology“
- high system service life of up to 100,000 h, saves premature replacement and conserves valuable resources
- high energy cost savings thanks to low connected load and high efficiency
- fast mounting and commissioning due to 1-point suspension and external quick connection
- sustainable, control gear and LED-module replaceable by qualified personnel on-site

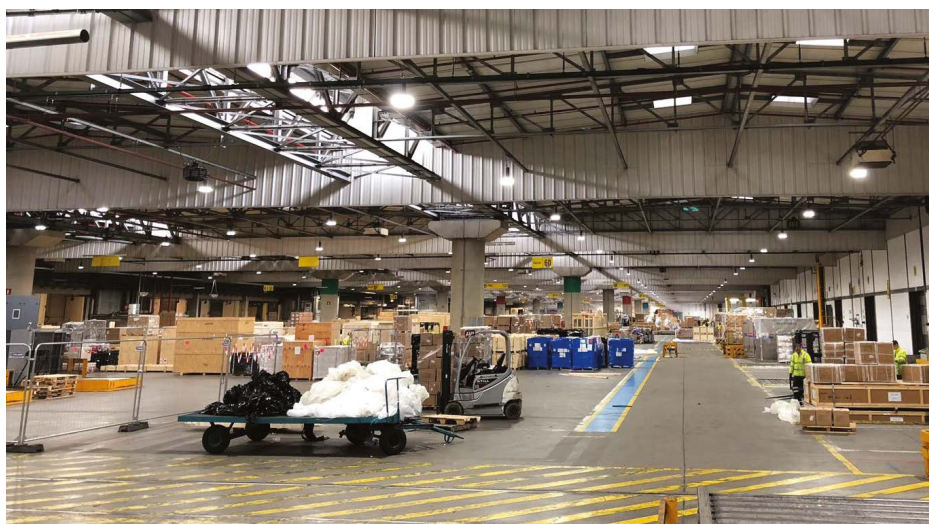

Properties, limitations and details for controlling LED-light fittings:

See "Technical Supplement"

All data are correct at the time of printing. Actual technical data can be found under www.schuch.de.

The versions with optics (B, TB and T) are suitable for use in food areas (IFS / HACCP).

Article no.	Type	dimmmable	Wide beam	Narrow wide beam	Narrow beam	Tmax [°C]	Weight [kg] (without packing material)	Connected load [W]	Luminous flux [lm]	Light output [lm/W]	Substitute for *
-------------	------	-----------	-----------	------------------	-------------	-----------	--	--------------------	--------------------	---------------------	------------------

3403... G3



colour temperature 4.000K (light colour 840)

34032 0017	3403 L270 G3		•			60	7,5	166	27.000	163	HIE 400 (HS-VG), HIT 400
34032 0019	3403 L270B G3		•								
34032 0021	3403 L270TB G3			•							
34032 0023	3403 L270T G3				•						
34032 0018	3403 L270 G3 DIMD	•	•								
34032 0020	3403 L270B G3 DIMD	•	•								
34032 0022	3403 L270TB G3 DIMD	•		•							
34032 0024	3403 L270T G3 DIMD	•			•						

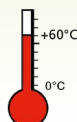

colour temperature 5.000K (light colour 850)

34032 0001	3403 L270 G3 850		•			60	7,5	166	27.000	163	HIE 400 (HS-VG), HIT 400
34032 0003	3403 L270B G3 850		•								
34032 0005	3403 L270TB G3 850			•							
34032 0007	3403 L270T G3 850				•						
34032 0002	3403 L270 G3 DIMD 850	•	•								
34032 0004	3403 L270B G3 DIMD 850	•	•								
34032 0006	3403 L270TB G3 DIMD 850	•		•							
34032 0008	3403 L270T G3 DIMD 850	•			•						

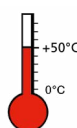

colour temperature 4.000K (light colour 840)

34032 0025	3403 L400 G3		•			50	8,0	250	40.000	160	HME 700, HIT 400
34032 0027	3403 L400B G3		•								
34032 0029	3403 L400TB G3			•							
34032 0031	3403 L400T G3				•						
34032 0026	3403 L400 G3 DIMD	•	•								
34032 0028	3403 L400B G3 DIMD	•	•								
34032 0030	3403 L400TB G3 DIMD	•		•							
34032 0032	3403 L400T G3 DIMD	•			•						

colour temperature 5.000K (light colour 850)

34032 0009	3403 L400 G3 850		•			50	8,0	250	40.000	160	HME 700, HIT 400
34032 0011	3403 L400B G3 850		•								
34032 0014	3403 L400TB G3 850			•							
34032 0015	3403 L400T G3 850				•						
34032 0010	3403 L400 G3 DIMD 850	•	•								
34032 0012	3403 L400B G3 DIMD 850	•	•								
34032 0013	3403 L400TB G3 DIMD 850	•		•							
34032 0016	3403 L400T G3 DIMD 850	•			•						

* The given information is for rough orientation only. In each individual case a lighting calculation is necessary. (VG = ballast)

Accessories / Spare Parts

Article no.	Type	
34011 9001	ABD TRIANO ESGW	cover, clear safety glass pane (for 1 LED module), for 3401..., 3402..., 3403..., 3410..., 3420..., 3430...
34011 9003	ABD TRIANO PRA PMMA	cover, clear PMMA disc with outer prisms (for 1 LED module), for 3401..., 3402..., 3403..., 3410..., 3420..., 3430...
34011 9002	ABD TRIANO PC	cover, clear PC IFS disc (for 1 LED module), for 3401..., 3402..., 3403..., 3410..., 3420..., 3430...
34011 9004	ABD TRIANO B PC	cover, clear PC disc, wide beam (for 1 LED module), with optics, for 3401..., 3402..., 3403..., 3410..., 3420..., 3430...
34011 9005	ABD TRIANO TB PC	cover, clear PC disc, narrow-beam wide distribution (for 1 LED module), with optics, for 3401..., 3402..., 3403..., 3410..., 3420..., 3430...
34011 9006	ABD TRIANO T PC	cover, clear PC disc, narrow beam (for 1 LED module), with optics, for 3401..., 3402..., 3403..., 3410..., 3420..., 3430...
34031 0001	SAS 3403 G3	cover, shield galkvanized steel, painted as a dirt shield retrofitting, for 3403... G3

NEW

TRIANO XL Generation 3

LED High Bay Fitting

Series 3405... G3

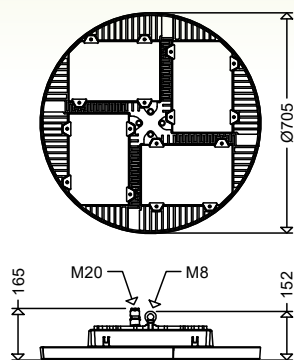

Applications:

Indoor areas with high mounting heights or with a requirement for high illumination levels. E.g. shipyards, hangars, machine-, maintenance- and assembly shops, hardware stores etc..

Design:

LED-segments: Robust four-part extruded aluminium housing with cooling fins, LED-modules and flat safety glasses (IK09)
All case parts powder coated in DB 702 (mica-iron paint, grey).

ECG-housing:

Cast aluminium
All case parts powder coated in DB 702,

smooth, matt.

Light distribution: With optics wide (B), narrow-wide (TB) or narrow beam (T).

Connection: 5-pole quick connection from the outside

Mounting: 1-point suspension, eyelet included.

Technical Data:

LED module: 4,000 K or 5,000 K, CRI > 80, service life $L_{95} > 100,000$ h, Zhaga compliant

ECG: 220-240 V, 50/60 Hz, Surge voltage resistance 4 kV, overload and short circuit protection.

Ambient temperature: -25 °C up to .. °C (see article tables)

Options:

- 5,000 K; light colour (850), e.g. in combination with TRIANO or TRIANO L high-bay luminaires
- in accordance with 'International Featured Standard Food' (IFS), with PC cover, without optics
- for higher ambient temperatures (H70), up to +70 °C
- for lower ambient temperatures (T40), down to -40 °C
- silicone-free

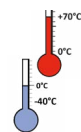

- Ready for Lightmanagement System (RFL)
- dimming function via DALI2 interface, compatible with LIMAS Line wired Light Management System (DIMD)
- power reduction with control phase (LR)
- constant luminous flux function (CL)
- radio-controlled Light Management System for industrial indoor areas (LIMAS Air)

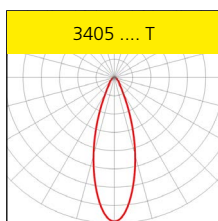
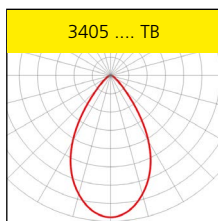
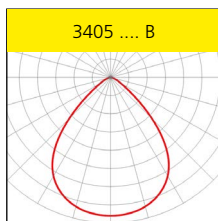

Product highlights:

- long-lasting, corrosion-resistant die-cast aluminium housing
- excellent thermal management through cooling fin structure and direct connection of the LED modules to the housing. Huge heat sink, excellent heat dissipation, excellent convection.
- uniform illumination due to the „Multi-Layer Technology“
- high system service life of up to 100,000 h, saves premature replacement and conserves valuable resources
- high energy cost savings thanks to low connected load and high efficiency
- fast mounting and commissioning due to 1-point suspension and external quick connection
- sustainable, control gear and LED-module replaceable by qualified personnel on-site
- GreenLine luminaire, outstanding sustainable design



! Properties, limitations and details for controlling LED-light fittings:

■ See "Technical Supplement"

All data are correct at the time of printing. Actual technical data can be found under www.schuch.de.

Article no.	Type	dimmable	Wide beam	Narrow wide beam	Narrow beam	Tmax [°C]	Weight [kg] (without packing material)	Connected load [W]	Luminous flux [lm]	Light output [lm/W]	Substitute for *
-------------	------	----------	-----------	------------------	-------------	-----------	--	--------------------	--------------------	---------------------	------------------

3405... G3



colour temperature 4.000K (light colour 840)

34052 0003	3405 L320B G3		•		
34052 0005	3405 L320TB G3			•	
34052 0007	3405 L320T G3				•
34052 0004	3405 L320B G3 DIMD	•	•		
34052 0006	3405 L320TB G3 DIMD	•		•	
34052 0008	3405 L320T G3 DIMD	•			•

60	15,6	190	34.200	180	HIT 400
----	------	-----	--------	-----	---------

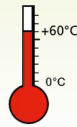

colour temperature 5.000K (light colour 850)

34052 0027	3405 L320B G3 850		•		
34052 0029	3405 L320TB G3 850			•	
34052 0031	3405 L320T G3 850				•
34052 0028	3405 L320B G3 DIMD 850	•	•		
34052 0030	3405 L320TB G3 DIMD 850	•		•	
34052 0032	3405 L320T G3 DIMD 850	•			•

60	15,6	190	34.200	180	HIT 400
----	------	-----	--------	-----	---------

colour temperature 4.000K (light colour 840)

34052 0011	3405 L450B G3		•		
34052 0013	3405 L450TB G3			•	
34052 0015	3405 L450T G3				•
34052 0012	3405 L450B G3 DIMD	•	•		
34052 0014	3405 L450TB G3 DIMD	•		•	
34052 0016	3405 L450T G3 DIMD	•			•

60	15,6	280	48.300	173	HIT 400, HME 700
----	------	-----	--------	-----	---------------------

colour temperature 5.000K (light colour 850)

34052 0035	3405 L450B G3 850		•		
34052 0037	3405 L450TB G3 850			•	
34052 0039	3405 L450T G3 850				•
34052 0036	3405 L450B G3 DIMD 850	•	•		
34052 0038	3405 L450TB G3 DIMD 850	•		•	
34052 0040	3405 L450T G3 DIMD 850	•			•

60	15,6	280	48.300	173	HIT 400, HME 700
----	------	-----	--------	-----	---------------------

colour temperature 4.000K (light colour 840)

34052 0019	3405 L600B G3		•		
34052 0021	3405 L600TB G3			•	
34052 0023	3405 L600T G3				•
34052 0020	3405 L600B G3 DIMD	•	•		
34052 0022	3405 L600TB G3 DIMD	•		•	
34052 0024	3405 L600T G3 DIMD	•			•

50	15,6	392	66.000	168	2 x HIT 400, HME 1000
----	------	-----	--------	-----	--------------------------

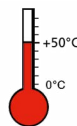

colour temperature 5.000K (light colour 850)

34052 0043	3405 L600B G3 850		•		
34052 0045	3405 L600TB G3 850			•	
34052 0047	3405 L600T G3 850				•
34052 0044	3405 L600B G3 850 DIMD	•	•		
34052 0046	3405 L600TB G3 850 DIMD	•		•	
34052 0048	3405 L600T G3 850 DIMD	•			•

50	15,6	392	66.000	168	2 x HIT 400, HME 1000
----	------	-----	--------	-----	--------------------------

* The given information is for rough orientation only. In each individual case a lighting calculation is necessary. (VG = ballast)

Accessories / Spare Parts

Article no.	Type	
34011 9011	ABD 3405 ESGW	cover, clear safety glass pane, for 3405... (1 segment)
34051 0002	SAS 3405 G3	cover, shield galvanized steel, painted as a dirt shield retrofitting, for 3405... G3

TRIANO *disc*

LED High Bay Fitting

Series 3410/3420/3430...

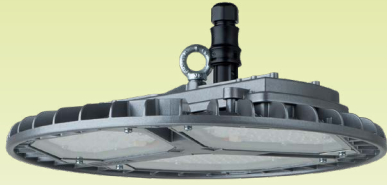

Applications:

Production and storage halls in trade and industry, maintenance halls, assembly plants, cold rooms, cold stores, hardware stores, rack aisles in warehouses, etc.

Design:

Robust die-cast aluminum body with cooling fins and integrated ECG housing. 1-3 LED-modules with PC-cover and incorporated optics.
All case parts powder coated in DB 702, smooth, matt.

Light distribution: wide- (B), narrow-wide (TB) or narrow beam (T).

Connection: 3-pole (DIMD 5-pole) quick-connector (**FastConnect**), plug mounted to the ECG-housing, socket included.

Mounting: 1-point suspension, eyelet included.

3410 ...

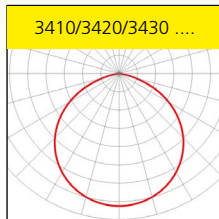
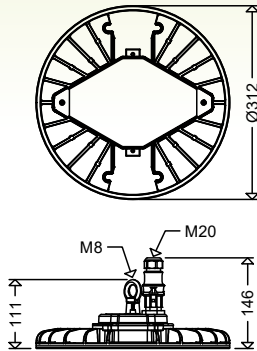

Technical Data:

LED module: 4,000 K or 5,000 K, CRI > 80, service life L_{90} > 50,000 h at 25 °C ambient temperature, service life L_{70} > 100,000h at max. ambient temperature
ECG: 220-240 V, 50/60 Hz, overload and short circuit protection.
Ambient temperature: -25 °C up to .. °C (see article tables)

Options:

- in accordance with 'International Featured Standard Food' (IFS), with PC cover, without optics
- PMMA cover, with prismatic structure to limit glare
- ball sports proof version (3420 and 3430 series only) 
- for connection to central emergency supply systems (ZB)
- dimming function via DALI2 interface, compatible with LIMAS Line wired Light Management System (DIMD)
- constant luminous flux function (CL)
- radio-controlled Light Management System for industrial indoor areas (LIMAS Air)
- with integrated infrared motion detector and brightness sensor, in combination with LIMAS Air CASA and LIMAS Line BASIC / PRO
- swivel bracket for ceiling or wall mounting
- cover tempered safety glass

3420 ...

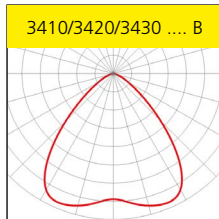
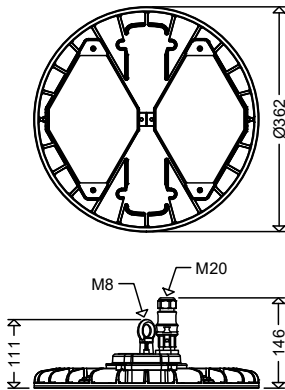

3430 ...

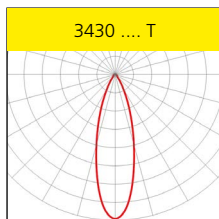
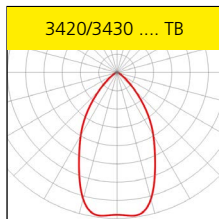
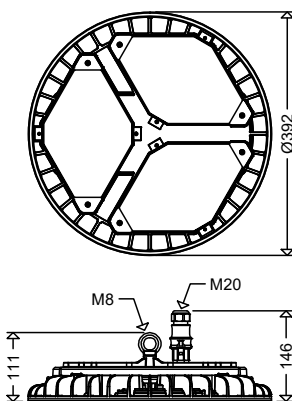

Product highlights:

- long-lasting, corrosion-resistant die-cast aluminium housing
- excellent thermal management through cooling fin structure and direct connection of the LED modules to the housing. Huge heat sink, excellent heat dissipation, excellent convection.
- uniform illumination due to the „Multi-Layer Technology“
- high system service life of up to 100,000 h, saves premature replacement and conserves valuable resources
- high energy cost savings thanks to low connected load and high efficiency
- fast mounting and commissioning due to 1-point suspension and FastConnect quick-connector
- sustainable, control gear and LED-module replaceable by qualified personnel on-site

High Bay Fittings



! Properties, limitations and details for controlling LED-light fittings:
■ See "Technical Supplement"

All data are correct at the time of printing. Actual technical data can be found under www.schuch.de.

The versions with optics (B, TB and T) are suitable for use in food areas (IFS / HACCP).

Article no.	Type	dimming	Wide beam	Narrow wide beam	Narrow beam	Tmax [°C]	Weight [kg] (without packing material)	Connected load [W]	Luminous flux [lm]	Light output [lm/W]	Substitute for *
-------------	------	---------	-----------	------------------	-------------	-----------	--	--------------------	--------------------	---------------------	------------------

3410/3420/3430...



3410...



colour temperature 4.000K (light colour 840)

34100 0011	3410 L100B D 840		•			50	2,1	65	10.000	154	HME 250
34100 0017	3410 L100B D DIMD 840	•	•								

colour temperature 5.000K (light colour 850)

34100 0003	3410 L100B D		•			50	2,1	65	10.000	154	HME 250
34100 0004	3410 L100B D DIMD	•	•								

colour temperature 4.000K (light colour 840)

34200 0011	3420 L200B D 840		•			45	2,8	123	20.000	163	HIT250, HME 400, HIE 400 (HI-VG)
34200 0015	3420 L200TB D 840			•							
34200 0012	3420 L200B D DIMD 840	•	•								
34200 0027	3420 L200TB D DIMD 840	•		•							

3420...



colour temperature 5.000K (light colour 850)

34200 0003	3420 L200B D		•			45	2,8	123	20.000	163	HIT250, HME 400, HIE 400 (HI-VG)
34200 0005	3420 L200TB D			•							
34200 0004	3420 L200B D DIMD	•	•								
34200 0006	3420 L200TB D DIMD	•		•							

3430...



colour temperature 4.000K (light colour 840)

34300 0014	3430 L300B D 840		•			45	4,0	195	30.000	154	HIE400 (HS-VG), HIT400
34300 0017	3430 L300TB D 840			•							
34300 0021	3430 L300T D 840				•						
34300 0016	3430 L300B D DIMD 840	•	•								
34300 0024	3430 L300TB D DIMD 840	•		•							
34300 0025	3430 L300T D DIMD 840	•		•							

colour temperature 5.000K (light colour 850)

34300 0003	3430 L300B D		•			45	4,0	195	30.000	154	HIE400 (HS-VG), HIT400
34300 0005	3430 L300TB D			•							
34300 0007	3430 L300T D				•						
34300 0004	3430 L300B D DIMD	•	•								
34300 0006	3430 L300TB D DIMD	•		•							
34300 0008	3430 L300T D DIMD	•		•							

* The given information is for rough orientation only. In each individual case a lighting calculation is necessary. (VG = ballast)

BestSelect – a selection of tried-and-tested SCHUCH luminaires for your everyday needs. More at: www.schuch.de/BestSelect

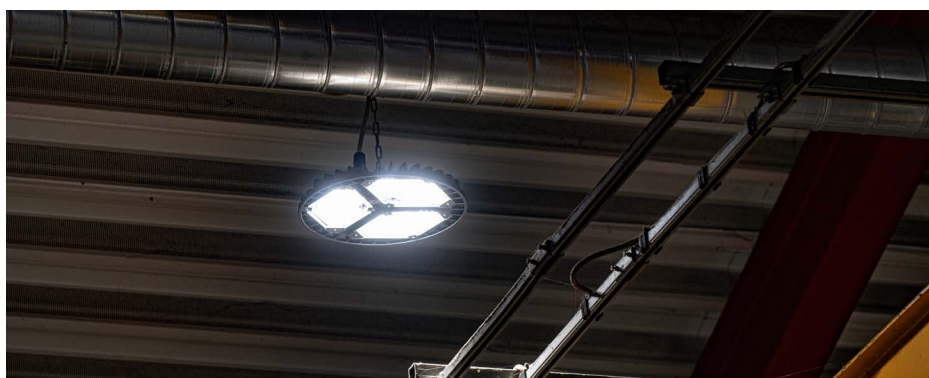

Accessories / Spare Parts

Article no.	Type	
34011 9001	ABD TRIANO ESGW	cover, clear safety glass pane (for 1 LED module), for 3401..., 3402..., 3403..., 3410..., 3420..., 3430...
34011 9003	ABD TRIANO PRA PMMA	cover, clear PMMA disc with outer prisms (for 1 LED module), for 3401..., 3402..., 3403..., 3410..., 3420..., 3430...
34011 9002	ABD TRIANO PC	cover, clear PC IFS disc (for 1 LED module), for 3401..., 3402..., 3403..., 3410..., 3420..., 3430...
34011 9004	ABD TRIANO B PC	cover, clear PC disc, wide beam (for 1 LED module), with optics, for 3401..., 3402..., 3403..., 3410..., 3420..., 3430...
34011 9005	ABD TRIANO TB PC	cover, clear PC disc, narrow-beam wide distribution (for 1 LED module), with optics, for 3401..., 3402..., 3403..., 3410..., 3420..., 3430...
34011 9006	ABD TRIANO T PC	cover, clear PC disc, narrow beam (for 1 LED module), with optics, for 3401..., 3402..., 3403..., 3410..., 3420..., 3430...



DUEVO

LED High Bay Fitting

Series 3301/3302...

Applications:

Production areas and warehouses, cool storage facilities, walkways in shelve areas, driveways etc.

Design:

Two versions are available: 1 (3301...) or 2 (3302...) LED-segments.

Housing: Die-cast aluminium, DB 702 (mica-iron paint, grey). **LED-segment(s)** with LED modules, optics and flat safety glass (IK10). **ECG segment** with integrated electronic control gear, prewired on terminals.

Light distribution: Without optics wide beam, with optics wide (B), narrow-wide (TB) or narrow beam (T), with oval optics (TO) for illumination of aisles in rack areas respectively asymmetrical beam (A).

Entries: 1 gland and 1 blind plug M25 x 1.5.

Mounting: 4 eyelets M6 included in delivery.

Technical Data:

LED module: 4,000 K, CRI > 80, service life $L_{50} > 100,000$ h, Zhaga compliant
ECG: 220-240 V, 50/60 Hz, Surge voltage resistance 4 kV, overload and short circuit protection.

Ambient temperature: -20°C up to .. °C (see article tables)

Options:

- 5,000 K; light colour (850)
- green LEDs, for lighting potato stores
- cable looping at 1 small side
- FastConnect (FC), quick plug-in connection
- PMMA cover, satinised (C), for glare limitation
- for lower ambient temperatures (T40), down to -40 °C
- for higher ambient temperatures (H80), up to +80 °C
- increased resistance (ER), against corrosive atmospheres
- high resistance (HR), against corrosive atmospheres
- ball-proof, with special ceiling mountings for sports halls
- for connection to central emergency supply systems (ZB)
- dimming function via DALI2 interface, compatible with LIMAS Line wired Light Management System (DIMD)
- power reduction with control phase (LR)
- constant luminous flux function (CL)
- additional overvoltage protection
- for wall mounting with wall brackets

Product highlights:

- long-lasting, corrosion-resistant die-cast aluminium housing
- optimized thermal management due to direct mounting of the LED modules to the housing and separate housings for ECG- and LED-modules, huge heat sink with excellent heat dissipation
- uniform illumination due to the „Multi-Layer Technology“
- high system service life of up to 100,000 h, saves premature replacement and conserves valuable resources
- variable electrical installation methods due to max. 8 cable entries (see options)
- high energy cost savings thanks to low connected load and high efficiency
- sustainable, control gear and LED-module replaceable by qualified personnel on-site
- future proof by using standardised LED-modules (Zhaga) and long-term availability of spare parts
- GreenLine luminaire, outstanding sustainable design

3301...

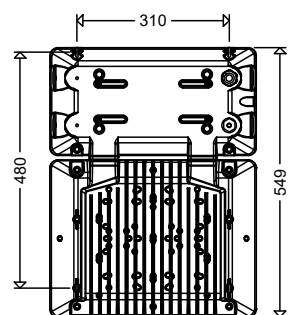
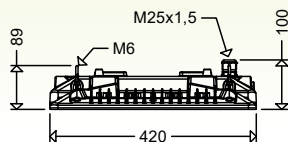

3302...

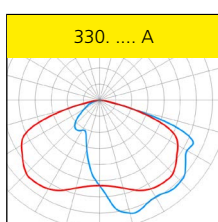
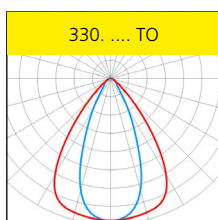
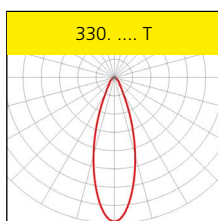
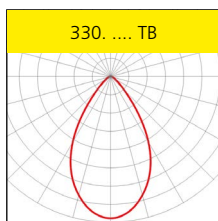
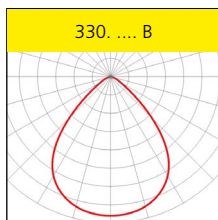
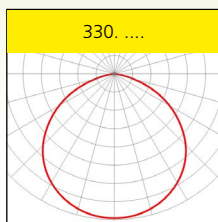
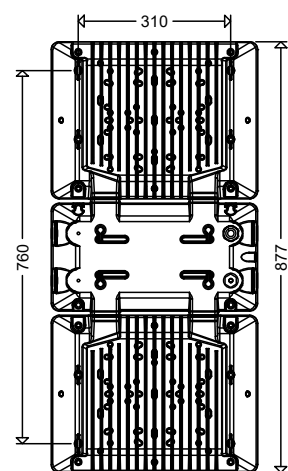

Properties, limitations and details for controlling LED-light fittings:

See "Technical Supplement"

All data are correct at the time of printing. Actual technical data can be found under www.schuch.de.

Article no.	Type	DAI controllable	Wide beam	Narrow wide beam	Narrow beam	Asymmetrical beam	Tmax [°C]	Weight [kg] (without packing material)	Connected load [W]	Luminous flux [lm]	Light output [lm/W]	Substitute for *
-------------	------	------------------	-----------	------------------	-------------	-------------------	-----------	--	--------------------	--------------------	---------------------	------------------

3301...



... for ambient temperatures up to +60 °C

1 LED segment

33010 0004	3301 L110				•		60	9,2	66	12.000	182	HME 250
33010 0006	3301 L110B				•							
33010 0015	3301 L110TB			•								
33010 0008	3301 L110T				•							
33010 0203	3301 L110 DIMD	•	•									
33010 0205	3301 L110B DIMD	•	•									
33010 0214	3301 L110TB DIMD	•		•								
33010 0207	3301 L110T DIMD	•			•							

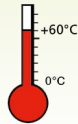

3301...



33010 0005	3301 L160				•		60	9,2	96	17.000	177	HIT 250, HME 400
33010 0007	3301 L160B				•							
33010 0016	3301 L160TB			•								
33010 0009	3301 L160T				•							
33010 0204	3301 L160 DIMD	•	•									
33010 0206	3301 L160B DIMD	•	•									
33010 0215	3301 L160TB DIMD	•		•								
33010 0208	3301 L160T DIMD	•			•							

... for ambient temperatures up to +50 °C

33010 0001	3301 L210				•		50	9,2	135	23.000	170	HIE 400
33010 0002	3301 L210B				•							
33010 0013	3301 L210TB			•								
33010 0003	3301 L210T				•							
33010 0014	3301 L210TO				•							
33010 0200	3301 L210 DIMD	•	•									
33010 0201	3301 L210B DIMD	•	•									
33010 0212	3301 L210TB DIMD	•		•								
33010 0202	3301 L210T DIMD	•			•							
33010 0213	3301 L210TO DIMD	•			•							

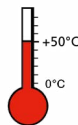

3302...



... for ambient temperatures up to +60 °C

2 LED segments

33020 0004	3302 L220				•		60	14,6	132	24.000	182	HIE 400
33020 0006	3302 L220B				•							
33020 0015	3302 L220TB			•								
33020 0008	3302 L220T				•							
33020 0203	3302 L220 DIMD	•	•									
33020 0205	3302 L220B DIMD	•	•									
33020 0214	3302 L220TB DIMD	•		•								
33020 0207	3302 L220T DIMD	•			•							

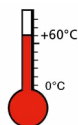

3302...



33020 0005	3302 L320				•		60	14,6	192	34.000	177	HIT 400
33020 0007	3302 L320B				•							
33020 0016	3302 L320TB			•								
33020 0009	3302 L320T				•							
33020 0204	3302 L320 DIMD	•	•									
33020 0206	3302 L320B DIMD	•	•									
33020 0215	3302 L320TB DIMD	•		•								
33020 0208	3302 L320T DIMD	•			•							

... for ambient temperatures up to +50 °C

33020 0001	3302 L420				•		50	14,6	270	46.000	170	2 x HIE 400
33020 0002	3302 L420B				•							
33020 0013	3302 L420TB			•								
33020 0003	3302 L420T				•							
33020 0014	3302 L420TO				•							
33020 0200	3302 L420 DIMD	•	•									
33020 0201	3302 L420B DIMD	•	•									
33020 0212	3302 L420TB DIMD	•		•								
33020 0202	3302 L420T DIMD	•			•							
33020 0213	3302 L420TO DIMD	•			•							

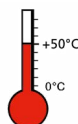

* This date is a rough guideline. In individual cases a lighting calculation is required.

Article no.	Type	Wide beam	Narrow wide beam	Narrow beam	Tmax [°C]	Weight [kg] (without packing material)	Connected load [W]	Luminous flux [lm] ¹⁾	Light output [lm/W]	Substitute for *
-------------	------	-----------	------------------	-------------	-----------	--	--------------------	----------------------------------	---------------------	------------------

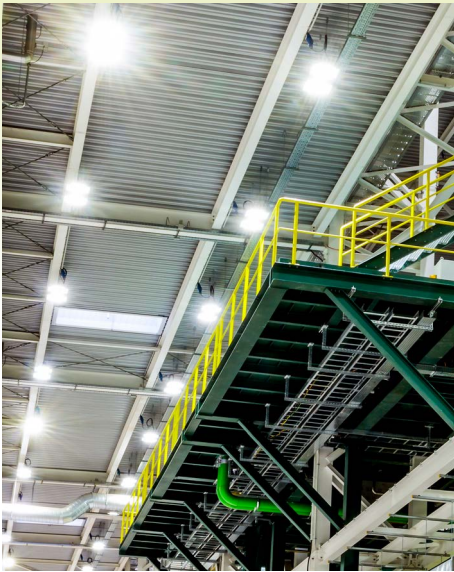

3301... / 3302... VARIO



Design:

Same as type 3301... / 3302... but: With a switch for for variable adjustment of the luminous flux in the luminaire. The connected load will change depending on the setting of the luminous flux.

Product highlights of the VARIO version:

- universally usable due to variable setting of the luminous flux, depending on the requirement
- simple and quick adjustment on-site without tools
- can be changed at any time (e.g. change of use of the premises with new requirements in regard to the level of illumination)
- maximum standardization and most economical warehousing



1 LED segment

Article no.	Type	Wide beam	Narrow wide beam	Narrow beam	Tmax [°C]	Weight [kg] (without packing material)	Connected load [W]	Luminous flux [lm]	Light output [lm/W]	Substitute for *
33011 0001	3301 L210 VARIO	•			50	9,2	77 - 135	13.600 - 23.000	177	HME 250 - HIE 400
33011 0002	3301 L210B VARIO	•								
33011 0003	3301 L210TB VARIO		•							
33011 0004	3301 L210T VARIO			•						

2 LED segments

Article no.	Type	Wide beam	Narrow wide beam	Narrow beam	Tmax [°C]	Weight [kg] (without packing material)	Connected load [W]	Luminous flux [lm]	Light output [lm/W]	Substitute for *
33021 0001	3302 L420 VARIO	•			50	14,6	154 - 270	27.200 - 46.000	177	HIE 400 - 2 x HIE 400
33021 0002	3302 L420B VARIO	•								
33021 0003	3302 L420TB VARIO		•							
33021 0004	3302 L420T VARIO			•						

Factory setting L210: 135 W; replaces approx. HIE 400
 Factory setting L420: 270 W; replaces approx. 2 x HIE 400

1) possible setting range

Article no.	Type	DALI controllable	Wide beam	Narrow wide beam	Narrow beam	Asymmetrical beam	Tmax [°C]	Weight [kg] (without packing material)	Connected load [W]	Luminous flux [lm]	Light output [lm/W]	Substitute for *
-------------	------	-------------------	-----------	------------------	-------------	-------------------	-----------	--	--------------------	--------------------	---------------------	------------------

3301/3302... IFS



IFS Food / BRC / VDMA / HACCP

SCHUCH Light Fittings designed for food and beverage industry applications are in accordance with IFS Food / BRC / VDMA standards. They can be operated without restrictions in operations that must fulfill the HACCP Concept.

for application in food industry areas

Applications:

Production halls in the food industry, locations which come under the requirements of the IFS Food (International Featured Standard, Food), BRC or HACCP, e.g. manufacture of food packaging.

Design:

With clear PC cover instead of the flat safety glass.

... for ambient temperatures up to +50 °C

1 LED segment

Article no.	Type	Wide beam	Narrow wide beam	Narrow beam	Tmax [°C]	Weight [kg] (without packing material)	Connected load [W]	Luminous flux [lm]	Light output [lm/W]	Substitute for *
33010 0010	3301 L210 IFS	•			50	9,2	135	23.000	170	HIE 400
33010 0011	3301 L210B IFS	•								
33010 0017	3301 L210TB IFS		•							
33010 0012	3301 L210T IFS			•						
33010 0209	3301 L210 DIMD IFS	•	•							
33010 0210	3301 L210B DIMD IFS	•	•							
33010 0216	3301 L210TB DIMD IFS	•	•	•						
33010 0211	3301 L210T DIMD IFS	•		•						

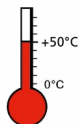

Optional also available for ambient temperatures up to +60 °C



2 LED segments

Article no.	Type	Wide beam	Narrow wide beam	Narrow beam	Tmax [°C]	Weight [kg] (without packing material)	Connected load [W]	Luminous flux [lm]	Light output [lm/W]	Substitute for *
33020 0010	3302 L420 IFS	•			50	14,6	270	46.000	170	2 x HIE 400
33020 0011	3302 L420B IFS	•								
33020 0017	3302 L420TB IFS		•							
33020 0012	3302 L420T IFS			•						
33020 0209	3302 L420 DIMD IFS	•	•							
33020 0210	3302 L420B DIMD IFS	•	•							
33020 0216	3302 L420TB DIMD IFS	•	•	•						
33020 0211	3302 L420T DIMD IFS	•		•						

* This date is a rough guideline. In individual cases a lighting calculation is required.

Article no.	Type	DAI controllable	Wide beam	Narrow wide beam	Narrow beam	Asymmetrical beam	Tmax [°C]	Weight [kg] (without packing material)	Connected load [W]	Luminous flux [lm]	Light output [lm/W]	Substitute for *
-------------	------	------------------	-----------	------------------	-------------	-------------------	-----------	--	--------------------	--------------------	---------------------	------------------



3301... ER



for use in cattle and horse stables

Applications:

High stables with greater mounting heights from approx. 6 m.

Design:

With stainless steel eye bolts.

Attention: Fastening ropes, ceiling brackets and wall brackets must be made of stainless steel (on demand).

33010 0600	3301 L210 ER		•				50	9,2	135	23.000	170	HIE 400
33010 0602	3301 L210B ER		•									
33010 0603	3301 L210TB ER				•							



3301... LW



for use in pig stalls

Applications:

High stables with greater mounting heights from approx. 6 m as well as environments with high pollution.

Design:

Modified for high protection against ammonia and other corrosive atmospheres or harmful gases.

Attention: Fastening ropes, ceiling brackets and wall brackets must be made of stainless steel (on demand).

33010 0800	3301 L210 LW		•				50	9,2	135	23.000	170	HIE 400
33010 0801	3301 L210B LW		•									
33010 0802	3301 L210TB LW				•							

Gas-tight encapsulated light sensor

Specially developed for use in environments contaminated with harmful gases, our new LL XR DS4 light sensor is ideal for animal houses contaminated with ammonia. Robustly constructed and gas-tight encapsulated, it offers outstanding durability and reliability in these demanding areas.

See catalog chapter Light management Systems / LIMAS Line.

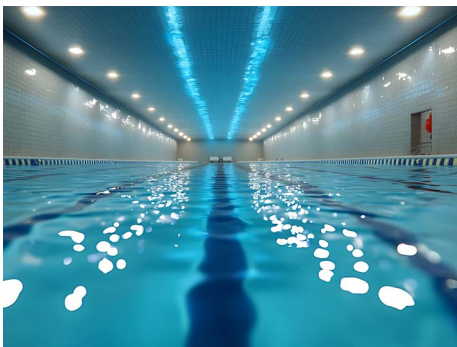

3301... SBL



for use in Swimming pools

Applications:

Swimming pools, indoor pools and chlorinated environments

Attention: Fixing cables, ceiling brackets and wall brackets must be specially designed (on request). Other versions 3302 ... also available on request.

Design:

Modified for high protection against chlorinated atmospheres.

33010 0900	3301 L210 SBL		•				50	9,2	135	23.000	170	HIE 400
33010 0901	3301 L210B SBL		•									
33010 0902	3301 L210TB SBL				•							
33010 0903	3301 L210A SBL					•						

* This date is a rough guideline. In individual cases a lighting calculation is required.

Accessories / Spare Parts

Article no.	Type	
33001 9001	ABD 3301 ESGW	cover, safety glass pane clear (1 segment), for 3301..., 3302..., 3305...
33001 9006	ABD 3301 PC	cover, disc PC clear IFS (1 segment), for 3301..., 3302..., 3305...
33001 9010	ABD 3301 C PMMA	cover, PMMA frosted disc for glare limitation (1 segment), for 3301..., 3302..., 3305...
90313 0003	KV M25 G BK	plastic cable gland M25 x 1,5
90313 0004	VSR M25 G BK	plastic screw plug M25 x 1,5
33001 9004	3301/3302 Y P	1 pair of Y-ropes, (2-point-mounting)
33001 9002	DBF 3301/3302	1 pair of brackets for direct ceiling mounting ¹⁾
33001 9013	SD 3301/3302	vibration absorbing suspension device ¹⁾

¹⁾Version Sheet Steel painted. Optional available in stainless steel painted.



DUEVO XL

LED High Bay Fitting

Series 3305...

Applications:

Production areas and warehouses, maintenance and assembly shops, cool storage facilities, walkways in rack areas, hardware stores etc.

Design:

Housing: Die-cast aluminum, DB 702 (mica-iron paint, grey). **4 segments** with LED module, optics behind tempered safety glass (IK10). **2 ECG segments** with integrated electronic control gear, pre-wired on terminals.

Light distribution: With optics wide (B), Narrow-wide (TB) or narrow beam (T).

Entries: 1 gland and 1 blind plug M25 x 1.5.

Mounting: On angle profile with 4 holes Ø 9 mm at a distance of 300mm, see accessories.

Delivery status: Multi-part

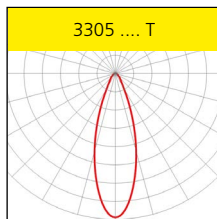
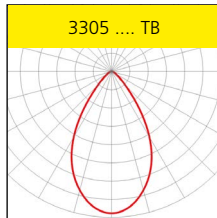
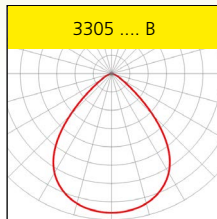
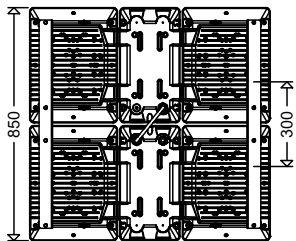
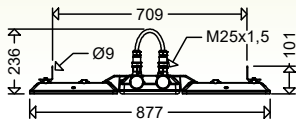

Technical Data:

LED module: 4,000 K, CRI > 80, service life $L_{95} > 100,000$ h at max. ambient temperature, Zhaga compliant

ECG: 220-240 V, 50/60 Hz, Surge voltage resistance 4 kV, overload and short circuit protection.

Ambient temperature: -25 °C up to .. °C (see article tables)

Options:

- 5,000 K; light colour (850)
- cable looping at 1 small side
- FastConnect (FC), quick-connector
- PMMA cover frosted (C) for glare limitation
- for lower ambient temperatures (T40), down to -40 °C
- for higher ambient temperatures (H80), up to +80 °C
- increased resistance (ER), against corrosive atmospheres
- high resistance (HR), against corrosive atmosphere
- for connection to central emergency supply systems (ZB)
- dimming function via DALI2 interface, compatible with LIMAS Line wired Light Management System (DIMD)
- power reduction with control phase (LR)
- constant luminous flux function (CL)
- additional overvoltage protection

Product highlights:

- long-lasting, corrosion-resistant die-cast aluminium housing
- optimized thermal management due to direct mounting of the LED modules to the housing and separate housings for ECG- and LED-modules, huge heat sink with excellent heat dissipation
- uniform illumination due to the „Multi-Layer Technology“
- high system service life of up to 100,000 h, saves premature replacement and conserves valuable resources
- variable electrical installation methods due to max. 8 cable entries (see options)
- high energy cost savings thanks to low connected load and high efficiency
- sustainable, control gear and LED-module replaceable by qualified personnel on-site
- future proof by using standardised LED-modules (Zhaga) and long-term availability of spare parts
- GreenLine luminaire, outstanding sustainable design

High Bay Fittings



! Properties, limitations and details for controlling LED-light fittings:
■ See "Technical Supplement"
 All data are correct at the time of printing. Actual technical data can be found under www.schuch.de.

Article no.	Type	Dimmable	Wide beam	Narrow wide beam	Narrow beam	Tmax [°C]	Weight [kg] (without packing material)	Connected load [W]	Luminous flux [lm]	Light output [lm/W]	Substitute for *
-------------	------	----------	-----------	------------------	-------------	-----------	--	--------------------	--------------------	---------------------	------------------

3305...



... for ambient temperatures up to +60 °C

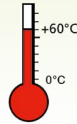

33050 0052	3305 L440B		•			60	30,3	264	48.000	182	2 x HIT 250, HME 400
33050 0059	3305 L440TB			•							
33050 0054	3305 L440T				•						
33050 0202	3305 L440B DIMD	•	•								
33050 0209	3305 L440TB DIMD	•		•							
33050 0204	3305 L440T DIMD	•			•						

33050 0053	3305 L640B		•			60	30,3	384	68.000	177	2 x HIT 400, HME 1000
33050 0060	3305 L640TB			•							
33050 0055	3305 L640T				•						
33050 0203	3305 L640B DIMD	•	•								
33050 0210	3305 L640TB DIMD	•		•							
33050 0205	3305 L640T DIMD	•			•						

... for ambient temperatures up to +50 °C

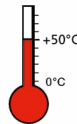

33050 0050	3305 L840B		•			50	30,3	540	92.000	170	2 x HIT 400, HME 1000
33050 0058	3305 L840TB			•							
33050 0051	3305 L840T				•						
33050 0200	3305 L840B DIMD	•	•								
33050 0208	3305 L840TB DIMD	•		•							
33050 0201	3305 L840T DIMD	•			•						

3305... IFS



for application in food industry areas

Applications:

Production halls in the food industry, locations which come under the requirements of the IFS Food (International Featured Standard, Food), BRC, or HACCP, e.g. manufacture of food packaging.

Design:

With clear PC cover instead of the flat safety glass.

Optional also available for ambient temperatures up to +60 °C



... for ambient temperatures up to +50 °C

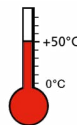

33050 0056	3305 L840B IFS		•			50	26,7	540	92.000	170	2 x HIT 400, HME 1000
33050 0061	3305 L840TB IFS			•							
33050 0057	3305 L840T IFS				•						
33050 0206	3305 L840B DIMD IFS	•	•								
33050 0211	3305 L840TB DIMD IFS	•		•							
33050 0207	3305 L840T DIMD IFS	•			•						

* This date is a rough guideline. In individual cases a lighting calculation is required.

Accessories / Spare Parts

Article no.	Type	
33001 9001	ABD 3301 ESGW	cover, safety glass pane clear (1 segment), for 3301..., 3302..., 3305...
33001 9006	ABD 3301 PC	cover, disc PC clear IFS (1 segment), for 3301..., 3302..., 3305...
33001 9010	ABD 3301 C PMMA	cover, PMMA frosted disc for glare limitation (1 segment), for 3301..., 3302..., 3305...
90313 0003	KV M25 G BK	plastic cable gland M25 x 1,5
90313 0004	VSR M25 G BK	plastic screw plug M25 x 1,5
33001 9012	3305 Y P	1 pair of Y-ropes (2-point-mounting)

NEW

AREALO 2

LED High Bay Fitting

Series 7955...

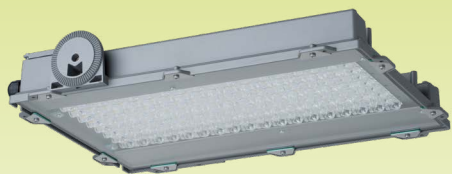

Applications:

Production and storage halls in commerce and industry, cold rooms, cold stores, DIY stores, aisles in warehouses, covered areas such as driveways, petrol stations, etc.

Design:

Housing: Die-cast aluminum, DB 702 (mica-iron paint, grey), with LED modules and flat safety glass (IK09).

Light distribution: Without optics wide

beam, with optics wide beam (B), narrow wide beam (TB) or narrow beam (T), narrow oval beam (TO) for illumination of aisles in rack areas respectively asymmetrical beam (A).

Entries: 1 gland M25 x 1.5.

Connection: 3-pole (DIMD 5-pole) plug-in terminal in the connection chamber.

Mounting: 4 eyelets included in delivery.

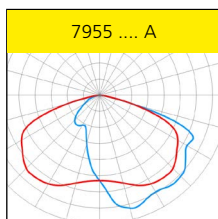
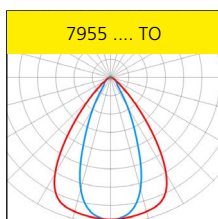
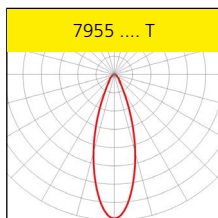
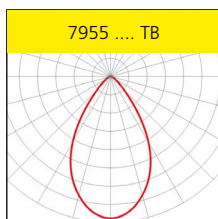
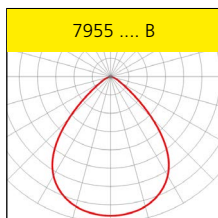
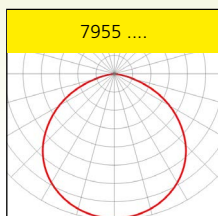
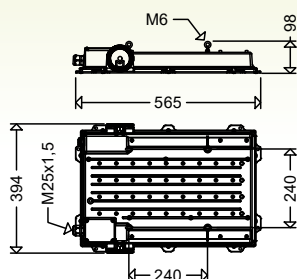

Technical Data:

LED module: 4,000 K, CRI > 80, service life L_{95} > 100,000 h at max. ambient temperature, Zhaga compliant

ECG: 220-240 V, 50/60 Hz, overload and short circuit protection.

Ambient temperature: -25°C up to .. °C (see article tables)

Options:

- 5,000 K; light colour (850)
- green LEDs, for lighting potato stores
- cable looping at 1 small side
- for lower ambient temperatures (T40), down to -40 °C
- increased resistance (ER), against corrosive atmospheres
- for connection to central emergency supply systems (ZB)
- power reduction with control phase (LR)
- constant luminous flux function (CL)
- radio-controlled Light Management System for industrial indoor areas (LIMAS Air)
- additional overvoltage protection

Product highlights:

- long-lasting, corrosion-resistant die-cast aluminium housing
- optimized thermal management due to direct mounting of the LED modules to the housing, large cooling surface, excellent heat dissipation
- uniform illumination due to the „Multi-Layer Technology“
- high system service life of up to 100,000 h, saves premature replacement and conserves valuable resources
- high energy cost savings thanks to low connected load and high efficiency
- sustainable, control gear and LED-module replaceable by qualified personnel on-site
- future proof by using standardised LED-modules (Zhaga) and long-term availability of spare parts
- GreenLine luminaire, outstanding sustainable design

Properties, limitations and details for controlling LED-light fittings:

See "Technical Supplement"

All data are correct at the time of printing. Actual technical data can be found under www.schuch.de.



High Bay
Fittings

Article no.	Type	Dimmable	Wide beam	Narrow wide beam	Narrow beam	Asymmetrical beam	Tmax [°C]	Weight [kg] (without packing material)	Connected load [W]	Luminous flux [lm]	Light output [lm/W]	Substitute for *
-------------	------	----------	-----------	------------------	-------------	-------------------	-----------	--	--------------------	--------------------	---------------------	------------------

Dimming function via DALI2 interface, compatible with LIMAS Line wired Light Management System (DIMD).

7955...



... for ambient temperatures up to +65 °C

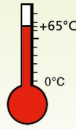

79550 0001	7955 L190				•							
79550 0002	7955 L190B				•							
79550 0003	7955 L190TB					•						
79550 0004	7955 L190T									•		
79550 0005	7955 L190TO									•		
79550 0006	7955 L190 DIMD	•	•									
79550 0007	7955 L190B DIMD	•	•									
79550 0008	7955 L190TB DIMD	•		•								
79550 0009	7955 L190T DIMD	•			•							
79550 0010	7955 L190TO DIMD	•				•						

65	8,2	102	19.900	195	HIE 400
----	-----	-----	--------	-----	---------

... for ambient temperatures up to +55 °C

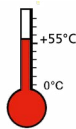

79550 0011	7955 L250				•							
79550 0012	7955 L250B				•							
79550 0013	7955 L250TB					•						
79550 0014	7955 L250T									•		
79550 0015	7955 L250TO									•		
79550 0016	7955 L250 DIMD	•	•									
79550 0017	7955 L250B DIMD	•	•									
79550 0018	7955 L250TB DIMD	•		•								
79550 0019	7955 L250T DIMD	•			•							
79550 0020	7955 L250TO DIMD	•				•						

55	8,2	144	27.500	191	HIE 400 (HS-VG), HIT 400
----	-----	-----	--------	-----	--------------------------

... for ambient temperatures up to +45 °C

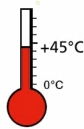

79550 0021	7955 L360				•							
79550 0022	7955 L360B				•							
79550 0023	7955 L360TB					•						
79550 0024	7955 L360T									•		
79550 0025	7955 L360TO									•		
79550 0026	7955 L360 DIMD	•	•									
79550 0027	7955 L360B DIMD	•	•									
79550 0028	7955 L360TB DIMD	•		•								
79550 0029	7955 L360T DIMD	•			•							
79550 0030	7955 L360TO DIMD	•				•						

45	8,2	205	38.300	187	HIT 400
----	-----	-----	--------	-----	---------

... for ambient temperatures up to +40 °C

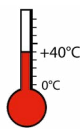

79550 0031	7955 L470				•							
79550 0032	7955 L470B				•							
79550 0033	7955 L470TB					•						
79550 0034	7955 L470T									•		
79550 0035	7955 L470TO									•		
79550 0036	7955 L470 DIMD	•	•									
79550 0037	7955 L470B DIMD	•	•									
79550 0038	7955 L470TB DIMD	•		•								
79550 0039	7955 L470T DIMD	•			•							
79550 0040	7955 L470TO DIMD	•				•						

40	8,5	289	52.000	180	2 x HIT 250, HME 400
----	-----	-----	--------	-----	----------------------

* This date is a rough guideline. In individual cases a lighting calculation is required.

IFS Food / BRC / VDMA / HACCP
 SCHUCH Light Fittings designed for food and beverage industry applications are in accordance with IFS Food / BRC / VDMA standards. They can be operated without restrictions in operations that must fulfill the HACCP Concept.

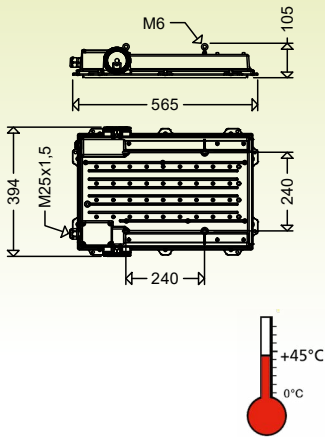

Article no.	Type	Dimmable	Wide beam	Narrow wide beam	Narrow beam	Asymmetrical beam	Tmax [°C]	Weight [kg] (without packing material)	Connected load [W]	Luminous flux [lm]	Light output [lm/W]	Substitute for *
-------------	------	----------	-----------	------------------	-------------	-------------------	-----------	--	--------------------	--------------------	---------------------	------------------

7955... IFS



for application in food industry areas

Applications:

Production halls in the food industry, locations which come under the requirements of the IFS Food (International Featured Standard, Food), BRC or HACCP, e.g. manufacture of food packaging.

Design:

With clear PC cover instead of the flat safety glass.

79550 0100	7955 L360 IFS		•				45	8,2	205	38.300	187	HIT 400
79550 0101	7955 L360B IFS		•									
79550 0102	7955 L360TB IFS			•								
79550 0103	7955 L360T IFS				•							
79550 0104	7955 L360TO IFS				•							
79550 0105	7955 L360 DIMD IFS	•	•									
79550 0106	7955 L360B DIMD IFS	•	•									
79550 0107	7955 L360TB DIMD IFS	•		•								
79550 0108	7955 L360T DIMD IFS	•			•							
79550 0109	7955 L360TO DIMD IFS	•			•							

* This date is a rough guideline. In individual cases a lighting calculation is required.

RFL - Ready for Light Management Systems

Design:

Same as standard version, but prepared for the subsequent use of a Light Management System. Integrated sockets allows retrofitting of Light Management components without tools.

Product highlights:

- standardised Zhaga Book 18 compliant sockets with D4i control gear
- subsequent use of a light management system possible at any time
- tool-free, quick assembly of the Light Management System accessories

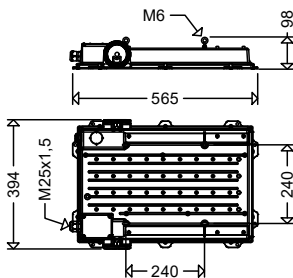

7955... RFL...



with a socket on the top side of the luminaire

79551 0001	7955 L360 RFLSO		•			45	8,2	205	38.300	187	HIT 400
79551 0002	7955 L360B RFLSO		•								
79551 0003	7955 L360TB RFLSO			•							
79551 0004	7955 L360T RFLSO				•						
79551 0005	7955 L360TO RFLSO				•						

System accessories

Article No.	Type	
90547 9011	LACA TAST4 AP	Battery-free, 4-button CASAMBI® radio switch. Actuating the switch generates the energy required to power the switch electronics
90547 9009	LACA TASTIF4 UP	CASAMBI® push-button interface for connecting up to 4 volt-free push-button inputs. Designed for installation in a flush-mounted wall box
90546 9013	RFL LACA FM DS	CASAMBI® radio module with light sensor for RFL sockets

Article no.	Type	Dimmable	Wide beam	Narrow wide beam	Narrow beam	Asymmetrical beam	Tmax [°C]	Weight [kg] (without packing material)	Connected load [W]	Luminous flux [lm]	Light output [lm/W]	Substitute for *
-------------	------	----------	-----------	------------------	-------------	-------------------	-----------	---	--------------------	--------------------	---------------------	------------------

7955... SBL



for use in Swimming pools

Applications:

Swimming pools, indoor pools and chlorinated environments

Design:

Modified for high protection against chlorinated atmospheres.

Attention:

Fastening cables, ceiling and wall mountings must be specially designed. Other versions 7955... are also available as SBL luminaires (on request).



79554 0001	7955 L360 SBL											
79554 0002	7955 L360B SBL											
79554 0003	7955 L360TB SBL											
79554 0004	7955 L360A SBL											
79554 0005	7955 L360 DIMD SBL											
79554 0006	7955 L360B DIMD SBL											
79554 0007	7955 L360TB DIMD SBL											
79554 0008	7955 L360A DIMD SBL											

45	8,2	205	38.300	187	HIT 400
----	-----	-----	--------	-----	---------

7955... V



for use in galvanising plants

Applications:

Specialty developed version or use in galvanizing plants.

Design:

As standard version 7955..., but: Stable support frame made of galvanised and painted steel.

Attention:

Fastening cables must be specially designed. Other versions 7955... are also available as V luminaires (on request).

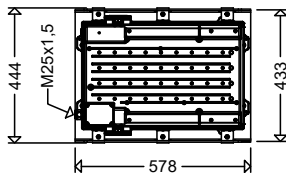
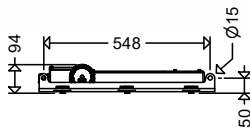

79553 0001	7955 L360 V											
79553 0002	7955 L360B V											
79553 0003	7955 L360TB V											
79553 0004	7955 L360T V											
79553 0006	7955 L360 DIMD V											
79553 0007	7955 L360B DIMD V											
79553 0008	7955 L360TB DIMD V											
79553 0009	7955 L360T DIMD V											

45	14,5	205	38.300	187	HIT 400
----	------	-----	--------	-----	---------

* This date is a rough guideline. In individual cases a lighting calculation is required.

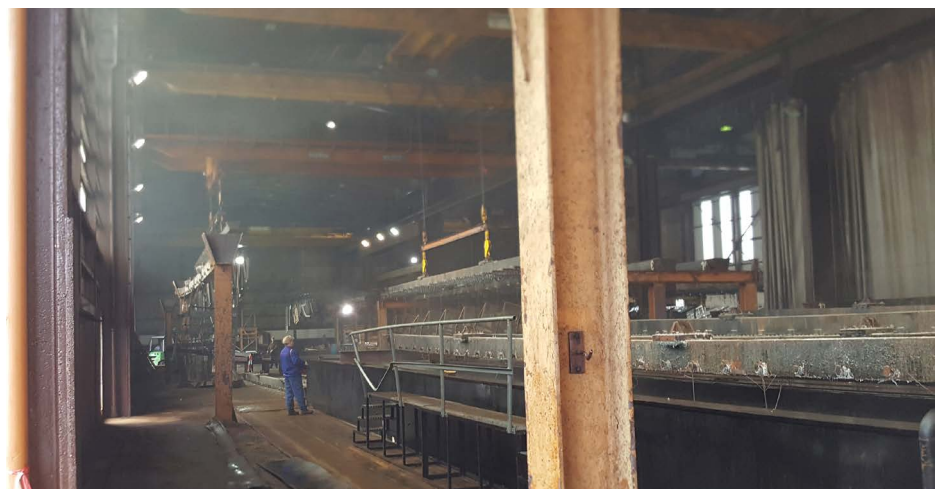

Accessories / Spare Parts

Article no.	Type	
79558 0001	ABD 7955 ESGW	cover, safety glass pane clear
79559 0001	WDBF 7955 ST	Wall and ceiling mounting, galvanised steel, painted in DB 702
79559 0003	WDBF 7955 E4	Wall and ceiling mounting, stainless steel V4A, for SBL version, painted in DB 702
79559 0004	7955 Y P ST	1 pair of Y-ropes



FOCO, FOCO L / XL

LED Floodlight for use in Swimming pools

Series 7600... SBL / 7700... SBL / 7800... SBL

Application:

Swimming pools, indoor pools and chlorinated environments.

Design:

Housing: Die-cast aluminium, 2-parts, powder coated DB 702 (mica-iron paint, grey), modified for high protection against chlorinated atmospheres.

Upper part: With LED- and optic-modules

Lower part: With electronic ballast, glass cover, cable entry with cable relief, retractable.

Glass: Flat safety glass pane, resistant to temperature changes, impact resistant IK09 (7600.../7800...) IK10 (7700...), silicone gasket.

Light distribution: without optics wide beam or asymmetrical beam (A)

Connection: 3-pole terminal, max. clamping range 2,5 mm².

Cable entry: 2 entries for M20 x 1.5 (7600... SBL, 7700... SBL) or M25 x 1.5 (7800... SBL), 1 cable gland and 1 screw plug each.

Mounting: Stainless steel bracket, swivel range 180°, with 3 drillings for wall- or ceiling mounting.

Series 7600... SBL

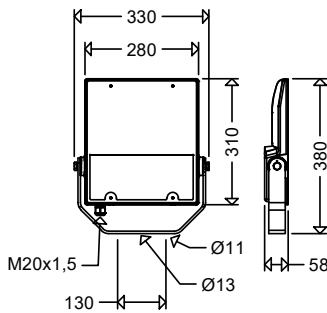

7600/7700/7800... SBL



7600/7700/7800... SBL A

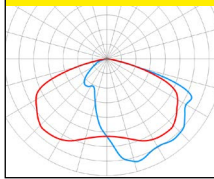

Electrical design:

LED module: 4,000 K, $R_a > 80$, service life $L_{95} > 100,000$ h at max. ambient temperature, Zhaga compliant

ECG: 220-240 V, 50/60 Hz, Surge voltage resistance 10 kV, excess temperature protection, overload and short circuit protection.

Ambient temperature: -40 °C up to +40 °C

Options:

- wide beam (B)
- narrow wide beam (TB)
- narrow beam (T)
- FastConnect (FC), quick connector
- special painting in RAL colours
- dimming function via DALI2 interface, compatible with LIMAS Line wired Light Management System (DIMD)
- output reduction with control phase (LR)
- constant luminous flux function (CL)
- radio-controlled Light Management System for industrial indoor areas (LIMAS Air)

Product highlights:

- modified, corrosion-protected version for use in chlorinated environments
- **sustainable**, control gear and LED-module replaceable by qualified personnel on-site
- **future proof** by using standardised LED-modules (Zhaga) and long-term availability of spare parts

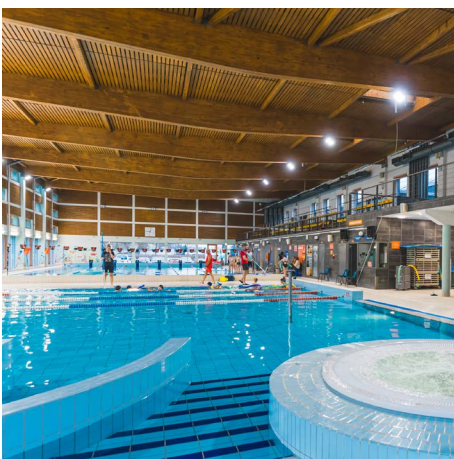

Article No.	Type	Connected load [W]	Luminous flux [lm]	Luminous efficacy [lm/W]	Weight [kg] (without packingmaterial)
IP66					
76003 001	7600 L50 SBL	3,8	35	5.800	166
76003 002	7600 L50A SBL				
76003 003	7600 L100 SBL	3,9	70	11.400	163
76003 004	7600 L100A SBL				

Properties, limitations and details for controlling LED-light fittings:

See "Technical Supplement"

All data are correct at the time of printing. Actual technical data can be found under www.schuch.de.

Series 7700... SBL

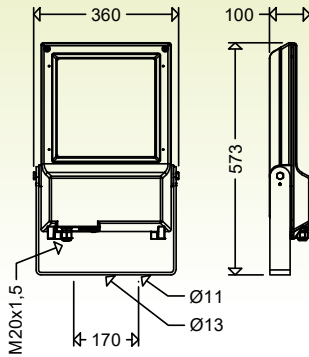

Series 7800... SBL

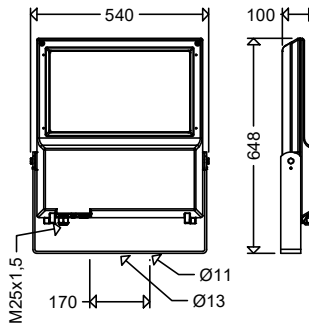

Article No.	Type	Connected load [W]	Luminous flux [lm]	Luminous efficacy [lm/W]	Weight [kg] (without packingmaterial)
-------------	------	--------------------	--------------------	--------------------------	--

7700... SBL



77006 0003	7700 L150 SBL	9,7	106	16.500	156
77006 0004	7700 L150A SBL				
77006 0005	7700 L210 SBL	9,7	140	21.600	154
77006 0006	7700 L210A SBL				

7800... SBL



78008 0003	7800 L420 SBL	17,0	280	43.800	156
78008 0004	7800 L420A SBL				

Accessories / Spare Parts

Article no.	Type	
76001 9000	ABD 7600 ESWG	cover, pane safety glass clear, for 7600...
78001 9002	ABD 7700 ESWG	cover, pane safety glass clear, for 7700...
78001 9001	ABD 7800 ESWG	cover, pane safety glass clear, for 7800...
90313 0001	KV M20 BK	plastic cable gland M20 x 1,5 black for 7700
90313 0005	VSR M20 BK	plastic plug M20 x 1,5 black for 7700
90313 0002	KV M25 BK	plastic cable gland M25 x 1,5 black for 7800
90313 0006	VSR M25 BK	plastic plug M25 x 1,5 black for 7800



FOCO L / XL LED Floodlight for sand/glass blasting area Series 7700... SSK / 7800... SSK

Application:

Blasting cubicles and areas in which products are sand and glasspearl blasted

Design:

Housing: Die-cast aluminium, 2-parts, powder coated DB 702 (mica-iron paint, grey).

Upper part: With LED- and optic-modules

Lower part: With electronic ballast, glass cover, cable entry with cable relief, retractable.

Glass: Flat safety glass pane, resistant to temperature changes, impact resistant

IK10. Additionally, one easy replaceable polycarbonate protective cover in a stainless steel frame in front of the glass pane, silicone gasket.

Light distribution: Narrow-wide

Connection: 3-pole terminal, max. clamping range 2,5 mm².

Cable entry: 2 cable entries M20 x 1.5 (1 cable gland and 1 screw plug).

Mounting: Mounting bracket, swivel range 180°, with 3 drillings for wall- or ceiling mounting.

Electrical design:

LED module: 4,000 K, R_a > 80, service life L₉₅ > 100,000 h at max. ambient temperature, Zhaga compliant

ECG: 220-240 V, 50/60 Hz, Surge voltage resistance 10 kV, excess temperature protection, overload and short circuit protection.

Ambient temperature: -40 °C up to +40 °C

Series 7700... SSK

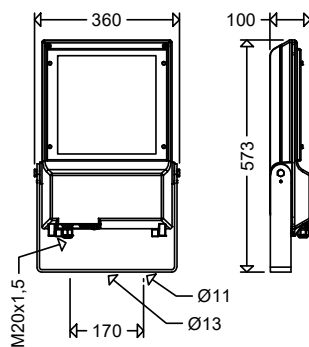

Swivel range

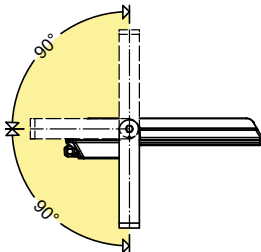

Standard Mounting

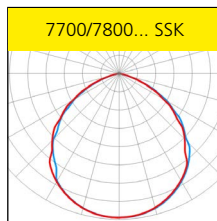
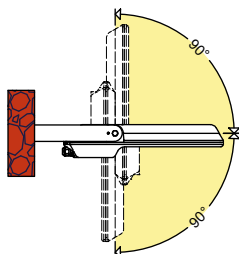

Options:

- narrow wide beam
- narrow beam
- FastConnect (FC), quick-connector
- special painting in RAL colours
- dimming function via DALI2 interface,
- compatible with LIMAS Line wired Light Management System (DIMD)
- power reduction with control phase (LR)
- constant luminous flux function (CL)

Product highlights:

- long-lasting, corrosion-resistant die-cast aluminium housing
- Reliable protection of the safety glass against damage and „blindness“ due to blasting material (‘PC wear cover’)
- optimized thermal management due to direct adaption of the LED-modules to the die-cast aluminium housing, large cooling surface, excellent heat dissipation
- homogeneous illumination due to the Multi-Layer-Technology
- comfortable maintenance due to removable lower part of the housing, large opening allows easy access to the terminal box and the electrical components
- sustainable, control gear and LED-module replaceable by qualified personnel on-site
- future proof by using standardised LED-modules (Zhaga) and long-term availability of spare parts

Article no.	Type	Connected load [W]	Luminous flux [lm]	Luminous efficacy [lm/W]	Weight [ca. kg] (without packaging)
-------------	------	--------------------	--------------------	--------------------------	-------------------------------------

7700... SSK



77005 0001	7700 L100 SSK	70	10.000	143	10,0
77005 0002	7700 L150 SSK	106	14.600	138	10,4
77005 0003	7700 L210 SSK	140	19.200	137	10,5

! Properties, limitations and details for controlling LED-light fittings:

■ See “Technical Supplement”

All data are correct at the time of printing. Actual technical data can be found under www.schuch.de.

Series 7800... SSK

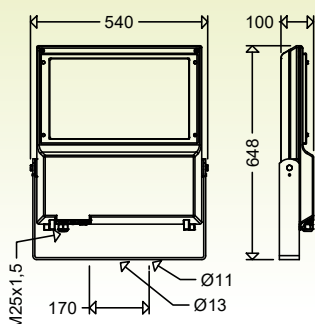

Swivel range

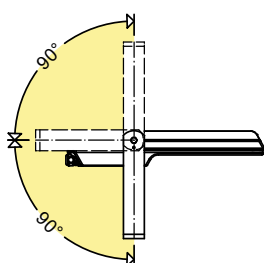

Standard Mounting

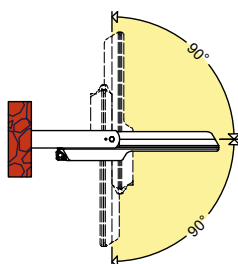

Article no.	Type	Connected load [W]	Luminous flux [lm]	Luminous efficacy [lm/W]	Weight [ca. kg] (without packaging)
-------------	------	--------------------	--------------------	--------------------------	-------------------------------------

7800... SSK



78005 0001	7800 L420 SSK	280	37.800	135	18,0
------------	----------------------	-----	--------	-----	------



Accessories / Spare Parts

Article no.	Type	
78001 9003	ABD 7700 SSK PC	cover, disc PC clear SSK, for 7700... SSK
78001 9002	ABD 7700 ESGW	cover, clear safety glass pane, for 7700...
78001 9004	ABD 7800 SSK PC	cover, clear PC pane SSK, for 7800... SSK
78001 9001	ABD 7800 ESGW	cover, clear safety glass pane, for 7800...
90313 0001	KV M20 BK	plastic cable gland M20 x 1,5 black for 7700
90313 0005	VSR M20 BK	plastic plug M20 x 1,5 black for 7700
90313 0002	KV M25 BK	plastic cable gland M25 x 1,5 black for 7800
90313 0006	VSR M25 BK	plastic plug M25 x 1,5 black for 7800



Outdoor Light Fittings

LED technology expands the scope

Since the first outdoor light fitting was produced in 1906, this area of production has become an integral part of the SCHUCH manufacturing program.

With this extremely long experience, SCHUCH now offers a wide range of technical and decorative LED light fittings which provide cost-effective lighting for streets, roads and squares, in compliance to the standards.

A good outdoor light fitting shall meet various requirements. It shall provide visibility conditions according to the standards, be photometrically optimized, be easy to install and maintain, and have a long service life.

With its design, a light fitting shall harmonically fit in the environment or set deliberately individual accents.

Economic efficiency and environmental compatibility have achieved new heights due to LED technology. In this regard, modern LED light fittings set completely new standards.

FROM OUTDOOR LIGHT FITTINGS WITH INCANDESCENT LAMPS TO OUTDOOR LED LIGHT FITTINGS

1906

Production of first street light fittings for incandescent lamps

1912

The outdoor lighting range has developed into a remarkable size and variety. Cast lid fittings for metal filament lamps, spherical light fittings and wall light fittings with cut glass are just as much a part of this as street lighting fixtures with reflectors and a large number of brackets and wall arms with elaborate decorations.

1935/1936

The "elegant and inexpensive" Type 10538 is the first modern mushroom-shaped top luminaire for parks and commercial gardens.

1949

Street light fittings for mercury vapor lamps were included in the manufacturing program.

1957

Production of the first street light fitting with a housing made of fiberglass-reinforced polyester using own "PREPEG".

1985

Production start of legendary street light fittings Series 43 and 44.



Outdoor Light Fittings

LED TECHNOLOGY

2009

First LED street light fittings were manufactured at the plant in Worms.

2011-2014

Production of first die-cast aluminium street light fittings (Series 47). Until 2014, the production range will be continuously expanded to include LED rope light fittings, LED floodlights and LED plane surface floodlights.

2015-2017

Introduction of the decorative LED-Street-Light-Fittings **KONIC**, **CUPINA** and **PLANE0**.

2016

The lighting becomes smart! Launch of **Light Management System LIMAS**.

2018

With the **FILOS VARIO** the first LED outdoor light fitting with variable adjustable luminous flux is launched to the market.

Due to this big success, the pole light fittings 47 and 48 VARIO as well as the Plane Surface Floodlight / Floodlight FOCO 7600 VARIO follows in short intervals.

2019

Fit for Future!

With the **RFL-concept** the light fittings are prepared for the later use of a Light Management System.

2020

The new **AREALO** large-area LED spotlight for illuminating sports facilities and large areas completes the LED floodlight and spotlight range.

2022/23

Launch of the **GreenLine** product line, which stands for outstanding sustainable products. The new **VIA** is the best example in this category.

2024

With the **BlackEdition series** of pole-top light fittings, we are consistently continuing on our path towards sustainable product design.

2025

Tool-free replacement of ECG and LED - what we started with the VIA, we are also realising with the new **REDONDO rope supported light fitting**. The **AREALO 2 large-area spotlight** has been further developed, making it lighter, more powerful and even more efficient. Standard versions of the CAMINO and FILOS VARIO will become part of the new **BestSelect** program, a selection of proven SCHUCH light fittings for everyday use.



Photo: Andrea Badrutt, Chur

Product	Series	Page
Light management		
LIMAS Air - Radio-based light management system		164
RFL-luminaires - Ready for Light Management Systems		165
Technical outdoor light fittings		
VIA	51/52...	166-169
• variable setting of luminous flux ... VARIO		168
• Ready for Light management ... RFL		169
CAMINO	48/47...	170-174
• for pedestrian crossings ... FUE		171
• variable setting of luminous flux ... VARIO		172
• Ready for Light management ... RFL		173
• Luminaires with DB listing Train platform lighting	47... DB	174
FILOS VARIO	42/42... AL VARIO	175-176
LUCA VARIO	46... G2 VARIO	177-178
Luminair with DB listing Low track lighting	131 nGgB DB	179
Rope supported		
PENDO	59/49...	180-182
• variable setting of luminous flux ... VARIO		181
• Ready for Light management ... RFL		182
REDONDO	55...	183-185
• variable setting of luminous flux ... VARIO		184
• Ready for Light management ... RFL		185
Decorative outdoor light fittings		
Pole-top light fittings Generation - 2 BlackEdition		
KONIC	544... G2	186-189
• variable setting of luminous flux ... VARIO		188
• Ready for Light management ... RFL		189
CUPINA	556... G2	190-192
• variable setting of luminous flux ... VARIO		192
PLANE0	557... G2	193-195
• variable setting of luminous flux ... VARIO		195
CILA	558... G2	196-198
• variable setting of luminous flux ... VARIO		198
CAPA	541... G2	199-201
• variable setting of luminous flux ... VARIO		201
RETRO	543... G2	202-204
• variable setting of luminous flux ... VARIO		204
RETRO Z	553... G2	205-207
• variable setting of luminous flux ... VARIO		207
Pendant light fittings		
BELLA	564/565... G2	208-210a
• variable setting of luminous flux ... VARIO		210
• Ready for Light management ... RFL		210a
Floodlights		
FOCO VARIO	7600... VARIO	211-213
• Ready for Light management ... RFL		213
FOCO L	7700/7800...	214-218
• variable setting of luminous flux ... VARIO		216
• Ready for Light management ... RFL		217
Large-Area Spotlight		
AREALO 2	7950...	219-223
Intelligent light control at sports facilities		223
Pole arm carriers		
Pole-top brackets		
Crossbars		
Connection cable		
		224
		225
		226
		227



Radio-based light management system

With the help of a Light Management System, the efficiency potential of LED technology can be optimally exploited.

Intelligent, demand-controlled light saves a great deal of energy costs and is extremely environmentally friendly and sustainable thanks to the considerable reduction in CO2 emissions associated with it. In addition, the networking of the light points opens up a wide range of options.

With light management systems from SCHUCH, you can now make your outdoor lighting smart in no time at all and take your system to a whole new level - extremely easily, quickly, and without any additional installation work.

In order to control luminaires via a light management system, they must have the appropriate interfaces. Choose from a wide range of compatible SCHUCH luminaires. Detailed information can be found on the relevant catalog pages for each series.

LIMAS Air SYNC Radio-based light management system for outdoor lighting and smart city applications





LIMAS Air SYNC is always the right choice when it comes to demand-based, intelligent control of lighting on streets, squares, parks, and industrial areas. Even complex smart city projects can be implemented with ease.

For further details and features, see the chapter on light management systems.

LIMAS Air CASA Radio-based light management system for sports facilities

There is considerable potential for energy savings in many areas, including sports facilities. With our **LIMAS Air CASA** light management system, you can conveniently control your flood light system via radio without additional wiring, while also achieving maximum energy cost savings. For further details and features, see the chapter on light management systems.

System components

Type	Art.-Nr.		
LASC DONGLE USB + SOFT + LIZ	90543 0001	USB radio adapter including software and license for on-site setup / programming of LIMAS Air SYNC systems	
LACA TASTIF4 UP	90547 9009	CASAMBI® push-button interface for connecting up to 4 volt-free push-button inputs. Designed for installation in a flush-mounted wall box	
LACA SENSBOX	10183 0002	External unit with integrated RFLS socket for connecting a radio module (can be combined with LIMAS Air CASA)	
LASC SENSBOX	Auf Anfrage	External unit with integrated radio module (2.4 GHz mesh network) for integrating various functions into a LIMAS Air SYNC system (compatible with LIMAS Air SYNC controllers)	

LIMAS Line Wired light management system

In some cases, choosing a wired light management solution may be the best option. For this reason, all outdoor luminaires in the DIMD version have a dimming function via a DALI-2 interface and are therefore also compatible with **LIMAS Line**.

For further details and features, see the chapter on light management systems.

When is the right time to implement a light management system? Right at the replacement of the conventional lighting or should you rather wait a few more years? Our RFL luminaires, that are prepared for retrofitting light management components, keep all options open for the future. Timing is yours.

One or two Zhaga Book 18 (Z18) compliant sockets with D4i control gear integrated into the luminaire housing enable the subsequent, tool-free installation of the necessary components such as controllers, radio antennas and sensors. The use of autonomous sensors without connection to a light management system is also possible at any time.

System components

Type	Art.-Nr.		
RFL LASC DS	90546 9014	Controller for radio control of RFL luminaires (2.4 GHz mesh network) with photocell (twilight switching)	
RFL LASC DS GPS SIM	90546 9010	Controller for radio control of RFL luminaires (2.4 GHz mesh network) with GPS antenna (automatic luminaire position determination) and photocell (twilight switching), with integrated SIM card for connecting up to 100 adjacent nodes to the cloud. Enables remote configuration / commissioning and monitoring of the system, and provides timing in the system (GPS)	
RFL LASC BM RAD8	90546 9011	Controller for radio control of RFL luminaires (2.4 GHz mesh network) with integrated radar motion sensors, maximum mounting height 8.0 m	
RFL LASC BM RAD10 MA MK2	90546 9012	Controller for radio control of RFL luminaires (2.4 GHz mesh network) with integrated radar motion sensors, designed for pole mounting, maximum mounting height 10.0 m	
RFL BM RAD12	90546 9017	Radar motion sensor for RFL luminaires with mounting heights up to max. 12.0 m - only permitted in conjunction with RFL radio control (no. 90546 9014 and 90546 9010)	
RFL BM/DS IR8	90546 9004	Infrared motion sensor for RFL luminaires with mounting heights up to max. 8.0 m - only permitted in conjunction with RFL radio control (no. 90546 9014 and 90546 9010)	
RFL BM/DS IR12	90546 9018	Infrared motion sensor / twilight sensor for RFL luminaires with mounting heights up to max. 12.0 m, suitable for standalone operation or for use in combination with RFL radio control (no. 90546 9014 and 90546 9010), compatible accessory: shielding mask for limiting the detection area (no. 90546 9020).	
RFL DS20	90546 9000	Twilight sensor for autonomous control of RFL luminaires. Use in conjunction with other system components not permitted	
RFL LACA FM DS	90546 9013	CASAMBI® radio module with light sensor for RFL sockets	



VIA LED Outdoor Light Fitting Series 51... / 52...

Applications:

Residential streets, by-roads, traffic-calmed zones, parks, walkways and cycle tracks, pedestrian zones, parks, green spaces, gateways, main streets, roundabouts, factory streets in industrial plants, car parks etc.

Design:

Housing: Die-cast aluminium, powder coated in DB 702, hinged with lockable safety clip. LED module and ECG mounted on support plates in upper part of housing, exchangeable without tools, disconnectable plug connection. Cable entry with screw connection, strain relief and pressure compensation system in lower part of housing, silicone seal.

Glass cover: Flat safety glass, impact resistance IK09.

Light distribution: Lens optics, asymmetrical wide beam

Central locking: Aluminium

Connection terminal: With disconnect plug connection and strain relief.

Universal-Pole mounting device: Die-cast aluminium, or mast top Ø 60/76 mm for pole-top or pole-mounted installation, pre-assembled for pole-top installation with 0° inclination. Separate reducing accessories are required for mast top Ø 42 mm.

Inclination setting: For pole-top installation 0°, 5°, 10° and 15° (factory setting 0°), for pole-mounting installation 0°, -5°, -10° and -15° depending on the inclination of the bracket arm, scaling on luminaire housing.

Electrical design:

LED module: 4,000 K or 3,000 K, $R_a > 70$, service life $L_{95} > 100,000$ h, Zhaga compliant

ECG: 220-240 V, 50-60 Hz, Surge voltage resistance 10 kV, overload and short circuit protection.

Options:

- 2,200 K; light colour (722)
- 1,800 K; light colour (518)
- asymmetrical beam (A)
- asymmetrical extremely wide beam (RWX), for illuminating cycle paths
- asymmetrical wide beam, low glare (ABL)
- special painting in RAL colours
- protection class I (SKI)
- seawater-resistant version
- bird deterrence
- for connection to a central power supply system (ZB)
- variable adjustable luminous flux via app (NFC)
- dimming function via DALI-2 interface, compatible with LIMAS Line wired Light Management System (DIMD)
- power reduction with control phase (LR)
- power reduction without control phase (LA)
- constant luminous flux function (CL)
- EcoTune
- additional overvoltage protection
- with backside light shielding (HA)
- inrush current limiter

51...

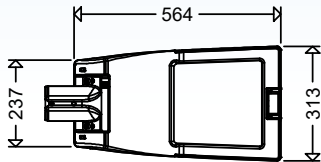

Pole-top installation

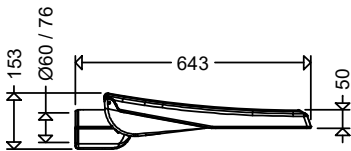

Pole-mounted installation

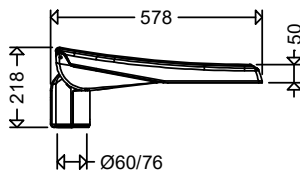

52...

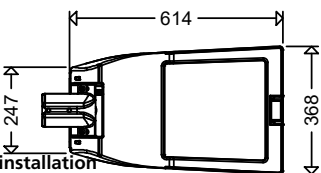

Pole-top installation

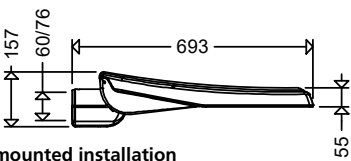

Pole-mounted installation

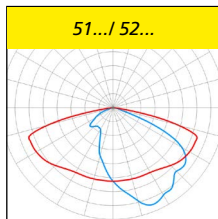
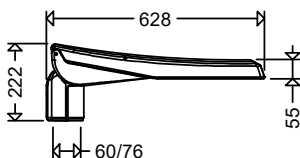

Product highlights:

- durable, corrosion-resistant die-cast aluminium housing with flat surface without cooling fins
- excellent thermal management, long service life
- integrated pressure equalisation system prevents condensation in the interior
- can be opened without tools (central locking)
- pre-assembled universal pole attachment for pole top Ø 60/76 mm for pole attachment or pole top mounting
- tool-free replacement of ECG and LED module
- homogeneous illumination due to the Multi-Layer-Technology
- eco-friendly, no light emission into the upper half-space, ULOR=0
- versions dimmable to 10% and with color temperature up to 3,000 K comply with Dark Sky requirements
- future proof by using standardised LED-modules (Zhaga) and long-term availability of spare parts
- GreenLine luminaire, outstanding sustainable design

SCHUCH outdoor luminaires in ZB design meet all relevant requirements for emergency luminaires for illuminating escape routes and assembly points (DIN EN 1838 / DIN EN 50172 VDE 0108-100:2024-10 / EN 60598 Part 2-22). The luminous flux in emergency mode can be selected between 10-100 %. Programming is carried out at the factory.



EcoTune luminaires from SCHUCH adapt flexibly to changing situations, taking into account safety, residents' interests and ecological aspects of night-time lighting. The luminaires combine either two light colours or optics: With light colours (e.g. 4,000 K and 2,200 K), the light can be changed from neutral white in the morning to warm white in the evening and optionally controlled via motion sensors, while the combination of two optics with different light distributions reduces glare on wet roads.

Further information on EcoTune can be found in our outdoor luminaires catalogue.

! Properties, limitations and details for controlling LED-light fittings:

■ See "Technical Supplement"

All data are correct at the time of printing. Actual technical data can be found under www.schuch.de.

All light fittings also available with connected cable (see accessories in the data sheet).



Article no.	Type	Connected load [W]	Luminous flux [lm]	Luminous efficacy [lm/W]	Weight [kg] (without packing material)
-------------	------	--------------------	--------------------	--------------------------	--

51... / 52...



colour temperature 4.000K (light colour 740)

51000 0001	51 0801	9	1.490	166	8,0
51000 0002	51 0802	13	2.080	160	8,0
51000 0003	51 0803	18	2.810	156	8,0
51000 0004	51 1601	17	2.900	171	8,0
51000 0005	51 1602	25	4.050	162	8,0
51000 0006	51 1603	35	5.480	157	8,0
51000 0007	51 2401	26	4.470	172	8,1
51000 0008	51 2402	37	6.200	168	8,1
51000 0009	51 2403	53	8.340	157	8,4
51000 0010	51 3201	34	5.890	173	8,5
51000 0011	51 3202	50	8.170	163	8,5
51000 0012	51 3203	70	10.950	156	8,5
51000 0053	51 4801	52	8.770	169	8,6
51000 0054	51 4802	75	12.150	162	8,6
51000 0055	51 4803	106	16.270	153	8,6
52000 0004	52 4801	52	9.060	174	10,7
52000 0005	52 4802	75	12.550	167	10,7
52000 0006	52 4803	106	16.730	158	10,7
52000 0007	52 6401	69	11.930	173	10,8
52000 0008	52 6402	99	16.490	167	10,8
52000 0009	52 6403	140	21.980	157	10,8
52000 0010	52 8001	86	14.530	169	11,0
52000 0011	52 8002	124	20.000	161	11,0
52000 0012	52 8003	175	26.520	152	11,0

colour temperature 3.000K (light colour 730)

51000 0037	51 0801 730	9	1.420	158	8,0
51000 0038	51 0802 730	13	1.980	152	8,0
51000 0039	51 0803 730	18	2.670	148	8,0
51000 0040	51 1601 730	17	2.760	162	8,0
51000 0041	51 1602 730	25	3.850	154	8,0
51000 0042	51 1603 730	35	5.210	149	8,0
51000 0043	51 2401 730	26	4.250	163	8,1
51000 0044	51 2402 730	37	5.890	159	8,1
51000 0045	51 2403 730	53	7.920	149	8,4
51000 0046	51 3201 730	34	5.600	165	8,5
51000 0047	51 3202 730	50	7.760	155	8,5
51000 0048	51 3203 730	70	10.400	149	8,5
51000 0056	51 4801 730	52	8.330	160	8,6
51000 0057	51 4802 730	75	11.540	154	8,6
51000 0058	51 4803 730	106	15.460	146	8,6
52000 0016	52 4801 730	52	8.610	166	10,7
52000 0017	52 4802 730	75	11.920	159	10,7
52000 0018	52 4803 730	106	15.890	150	10,7
52000 0019	52 6401 730	69	11.330	164	10,8
52000 0020	52 6402 730	99	15.670	158	10,8
52000 0021	52 6403 730	140	20.880	149	10,8
52000 0022	52 8001 730	86	13.800	160	11,0
52000 0023	52 8002 730	124	19.000	153	11,0
52000 0024	52 8003 730	175	25.190	144	11,0

All light fittings also available with connected cable (see accessories in the data sheet).

Article No.	Type	Connected load [W]	Luminous flux [lm] ¹⁾	Luminous efficacy [lm/W] (up to)	Substitute for ca. *	Weight [kg] (without packing material)
-------------	------	--------------------	----------------------------------	----------------------------------	----------------------	--

51... / 52... VARIO

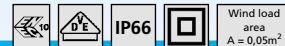

Design:

Same as type 51... / 52... but: With switch for for variable adjustment of the luminous flux in the luminaire.

Product highlights of the VARIO version:

- simple, fast, tool-free setting of the luminous flux on site, by means of integrated switch, can be changed at any time
- reduction in the variety of types



colour temperature 4.000K (light colour 740)

51001 0001	51 L50 VARIO	9 - 35	1.330 - 5.480	172	HST 35 - 2 x HST 70	8,5
51001 0002	51 L100 VARIO	16 - 70	2.720 - 10.950	175	HST 50 - HSE 150	8,6
51001 0003	51 L150 VARIO	24 - 106	4.050 - 16.270	169	2 x HME 80 - 2 x HME 250	8,6
52001 0002	52 L150 VARIO	24 - 106	4.190 - 16.730	175	2 x HME 80 - 2 x HME 250	10,7
52001 0003	52 L210 VARIO	32 - 140	5.520 - 21.980	173	2 x HST 70 - HME 400	10,8
52001 0004	52 L250 VARIO	37 - 175	6.750 - 26.520	182	2 x HST 70 - HST 250	11,0

colour temperature 3.000K (light colour 730)

51001 0004	51 L50 VARIO 730	9 - 35	1.260 - 5.210	163	HST 35 - 2 x HST 70	8,5
51001 0005	51 L100 VARIO 730	16 - 70	2.580 - 10.400	167	HST 50 - HSE 150	8,6
51001 0006	51 L150 VARIO 730	24 - 106	3.850 - 15.460	160	2 x HME 80 - 2 x HME 250	8,6
52001 0006	52 L150 VARIO 730	24 - 106	3.980 - 15.890	166	2 x HME 80 - 2 x HME 250	10,7
52001 0007	52 L210 VARIO 730	32 - 140	5.240 - 20.880	164	2 x HST 70 - HME 400	10,8
52001 0008	52 L250 VARIO 730	37 - 175	6.410 - 25.190	173	2 x HST 70 - HST 250	11,0

Factory setting L50: 18 W; replaces approx. HME 125, HST 70

Factory setting L100: 54 W; replaces approx. HME 250

Factory setting L150: 106 W; replaces approx. 2 x HME 250

Factory setting L210: 140 W; replaces approx. HME 400

Factory setting L250: 175 W; replaces approx. HST 250

1) possible setting range

* The given information is for rough orientation only. In each individual case a lighting calculation is necessary.



All light fittings also available with connected cable (see accessories in the data sheet).

Article no.	Type	Connected load [W]	Luminous flux [lm]	Luminous efficacy [lm/W]	Weight [kg] (without packing material)
-------------	------	--------------------	--------------------	--------------------------	--

RFL - Ready for Light Management Systems

Design:

Same as standard version, but prepared for the subsequent use of a Light Management System. Integrated sockets allows retrofitting of Light Management components without tools.

Product highlights:

- standardised Zhaga Book 18 compliant sockets with D4i control gear
- subsequent use of a light management system possible at any time
- tool-free, quick assembly of the Light Management System components



51... / 52... RFL



with a socket on the top and bottom side of the luminaire

colour temperature 4.000K (light colour 740)

51003 0009	51 0803 RFLOU	18	2.810	156	8,0
51003 0010	51 1603 RFLOU	35	5.480	157	8,0
51003 0011	51 2403 RFLOU	53	8.340	157	8,4
51003 0012	51 3203 RFLOU	70	10.950	156	8,5
51003 0040	51 4803 RFLOU	106	16.270	153	8,6
52003 0008	52 4803 RFLOU	106	16.730	158	10,7
52003 0009	52 6403 RFLOU	140	21.980	157	10,8
52003 0021	52 8003 RFLOU	175	26.520	152	11,0

colour temperature 3.000K (light colour 730)

51003 0021	51 0803 730 RFLOU	18	2.670	148	8,0
51003 0022	51 1603 730 RFLOU	35	5.210	149	8,0
51003 0023	51 2403 730 RFLOU	53	7.920	149	8,4
51003 0024	51 3203 730 RFLOU	70	10.400	149	8,5
51003 0043	51 4803 730 RFLOU	106	15.460	146	8,6
52003 0017	52 4803 RFLOU 730	106	15.890	150	10,7
52003 0018	52 6403 RFLOU 730	140	20.880	149	10,8
52003 0024	52 8003 RFLOU 730	175	25.190	144	11,0

System accessories

Article No.	Type	
90546 9018	RFL BM/DS IR12	RFL motion sensor with light sensor, infrared (maximum light point height 12.0 m)
90546 9004	RFL BM/DS IR8	RFL motion sensor with light sensor, infrared (light point height max. 8.0 m)
90546 9000	RFL DS20	RFL control element with light sensor, standalone, 20 lx
90543 0001	LASC DONGLE USB + SOFT + LIZ	LIMAS Air SYNC USB dongle with software and licence
90546 9012	RFL LASC BM RAD10 MA MK2	RFL LIMAS Air SYNC light management controller (2.4 GHz mesh network) with motion sensor, radar (mounting height max. 10.0 m) for mast mounting with 2.0 m cable
90546 9011	RFL LASC BM RAD8	RFL LIMAS Air SYNC light management controller (2.4 GHz mesh network) with motion sensor, radar (max. light point height 8.0 m)
90546 9014	RFL LASC DS	RFL LIMAS Air SYNC light management controller (2.4 GHz mesh network) with light sensor
90546 9010	RFL LASC DS GPS SIM	RFL LIMAS Air SYNC light management controller (2.4 GHz mesh network) with light sensor, GPS antenna and eSIM

Other sensors, e.g. environmental sensors (fine dust, CO₂, weather station etc.) on request.

RZ 76/42 VIA



Pipe brackets for wall, pole and corner mounting, and post top brackets please see end of this chapter.

Accessories / Spare Parts

Article No.	Type	
51010 9000	ABD 51 ESGW	cover, pane safety glas clear, for 51...
52010 9000	ABD 52 ESGW	cover, pane safety glas clear, for 52...
90309 0001	RZ 76/42 VIA	adapter for mast top Ø 42 mm, black

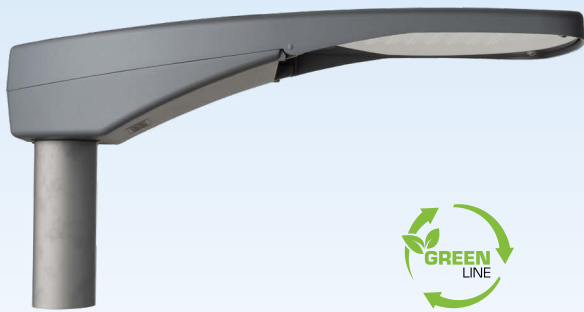

CAMINO LED Outdoor Light Fitting Series 48... / 47...

Applications:

Residential streets, by-roads, traffic-calmed zones, parks, walkways and cycle tracks, pedestrian zones, parks, green spaces, gateways, main streets, roundabouts, factory streets in industrial plants, car parks etc.

Design:

Housing: Die-cast aluminium, 2-parts, powder coated in DB 702.
Upper section with LED-Module, optics, glass cover and ECG, hinged and detachable. **Lower section** with pole mounting system, adjustment of inclination, cable retainer, cable entry with pressure compensation system.

Glass cover: Flat safety glass, impact resistance IK09.

Light distribution: Asymmetrical wide beam

Connection: With isolating plug connection with cable relief.

Universal pole mounting device: Die-cast aluminium, for post top mounting Ø 60/76 mm and side entry mounting Ø 60 mm. For side entry mounting Ø 42 mm, separate reducing accessories are required (see accessories / spare parts).

Inclination: Post top mounting 0°, 5° and 10° (factory setting 0°). Side entry mounting 0°, -5°, -10° and -15° depending on inclination of the cantilever.

Electrical design:

LED module: 4,000 K or 3,000 K, $R_a > 70$, service life $L_{50} > 100,000$ h, Zhaga compliant

ECG: 220-240 V, 50-60 Hz, Surge voltage resistance 10 kV, overload and short circuit protection.

Options:

- 2,200 K; light colour (722)
- 1,800 K; light colour (518)
- asymmetrical beam (A)
- asymmetrical extremely wide beam (RWX), for illuminating cycle paths
- asymmetrical wide beam, low glare (ABL)
- special painting in RAL colours
- protection class I (SKI)
- seawater-resistant version
- bird deterrence
- for connection to a central power supply system (ZB)
- variable adjustable luminous flux via app (NFC)
- dimming function via DALI-2 interface, compatible with LIMAS Line wired Light Management System (DIMD)
- power reduction with control phase (LR)
- power reduction without control phase (LA)
- constant luminous flux function (CL)
- EcoTune
- additional overvoltage protection
- with backside light shielding (HA)
- inrush current limiter

48...

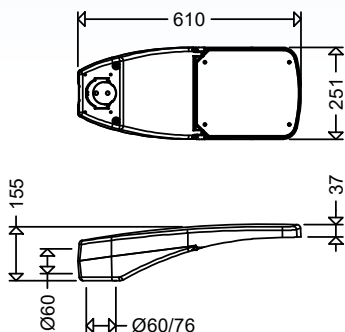

47...

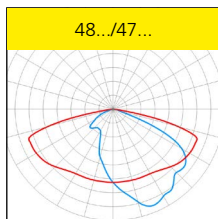
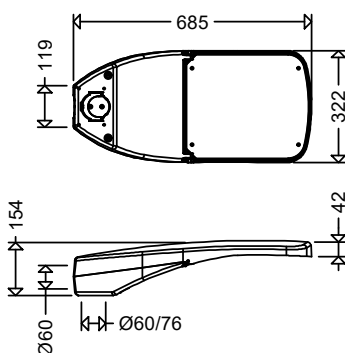

Product highlights:

- durable, corrosion-resistant die-cast aluminium housing with flat surface without cooling fins
- excellent thermal management, long service life
- integrated pressure compensation system prevents condensation in the interior
- universal pole mounting system, foldable **without tools**, for post top or side entry mounting
- removable upper part of the housing allows a comfortable, time- and cost-saving mounting in 2 steps:
1st step: Mount bottom part on the pole and connect the mains
2nd step: Hinge upper part, connect isolating plug and shut the housing. **READY**
- adjustable inclination of the light fitting, no tools required
- homogeneous illumination due to the Multi-Layer-Technology
- eco-friendly, no light emission into the upper half-space, **ULOR=0**
- versions dimmable to 10% and with color temperature up to 3,000 K comply with **Dark Sky requirements**
- sustainable, control gear and LED-module replaceable by qualified personnel on-site
- future-proof by using standardised LED-modules (Zhaga) and long-term availability of spare parts
- GreenLine luminaire, outstanding sustainable design

SCHUCH outdoor luminaires in ZB design meet all relevant requirements for emergency luminaires for illuminating escape routes and assembly points (DIN EN 1838 / DIN EN 50172 VDE 0108-100:2024-10 / EN 60598 Part 2-22). The luminous flux in emergency mode can be selected between 10-100 %. Programming is carried out at the factory.



EcoTune luminaires from SCHUCH adapt flexibly to changing situations, taking into account safety, residents' interests and ecological aspects of night-time lighting. The luminaires combine either two light colours or optics: With light colours (e.g. 4,000 K and 2,200 K), the light can be changed from neutral white in the morning to warm white in the evening and optionally controlled via motion sensors, while the combination of two optics with different light distributions reduces glare on wet roads.

Further information on EcoTune can be found in our outdoor luminaires catalogue.

Properties, limitations and details for controlling LED-light fittings:

See "Technical Supplement"

All data are correct at the time of printing. Actual technical data can be found under www.schuch.de.

All light fittings also available with connected cable (see accessories in the data sheet).

Article no.	Type	Connected load [W]	Luminous flux [lm]	Luminous efficacy [lm/W]	Weight [kg] (without packing material)
-------------	------	--------------------	--------------------	--------------------------	--

48... / 47...



colour temperature 4.000K (light colour 740)

48001 0030	48 0801	9	1.510	168	7,0
48001 0045	48 0802	13	2.100	162	7,0
48001 0046	48 0803	18	2.840	158	7,0
48001 0005	48 1601	17	2.900	171	7,0
48001 0006	48 1602	25	4.050	162	7,0
48001 0007	48 1603	35	5.480	157	7,0
48001 0047	48 2401	26	4.470	172	7,1
48001 0048	48 2402	37	6.210	168	7,1
48001 0049	48 2403	53	8.340	157	7,4
48001 0015	48 3201	34	5.940	175	7,5
48001 0016	48 3202	50	8.280	166	7,5
48001 0017	48 3203	70	11.140	159	7,5
47000 0003	47 3201	34	6.020	177	10,2
47000 0009	47 3202	50	8.400	168	10,2
47000 0004	47 3203	70	11.360	162	10,2
47000 0005	47 4801	52	8.980	173	10,2
47000 0010	47 4802	75	12.500	167	10,2
47000 0047	47 4803	106	16.850	159	10,2
47000 0007	47 6401	69	11.850	172	10,3
47000 0011	47 6402	99	16.440	166	10,3
47000 0048	47 6403	140	22.030	157	10,3

Outstanding mounting advantage



colour temperature 3.000K (light colour 730)

48001 0936	48 0801 730	9	1.430	159	7,0
48001 0391	48 0802 730	13	2.000	154	7,0
48001 0322	48 0803 730	18	2.700	150	7,0
48001 0099	48 1601 730	17	2.760	162	7,0
48001 0096	48 1602 730	25	3.850	154	7,0
48001 0097	48 1603 730	35	5.210	149	7,0
48001 0937	48 2401 730	26	4.250	163	7,1
48001 0143	48 2402 730	37	5.900	159	7,1
48001 0939	48 2403 730	53	7.920	149	7,4
48001 0120	48 3201 730	34	5.640	166	7,5
48001 0028	48 3202 730	50	7.870	157	7,5
48001 0018	48 3203 730	70	10.580	151	7,5
47000 0905	47 3201 730	34	5.720	168	10,2
47000 0100	47 3202 730	50	7.980	160	10,2
47000 0090	47 3203 730	70	10.790	154	10,2
47000 0383	47 4801 730	52	8.530	164	10,2
47000 0075	47 4802 730	75	11.880	158	10,2
47000 0076	47 4803 730	106	16.010	151	10,2
47000 0362	47 6401 730	69	11.260	163	10,3
47000 0270	47 6402 730	99	15.620	158	10,3
47000 0088	47 6403 730	140	20.930	150	10,3

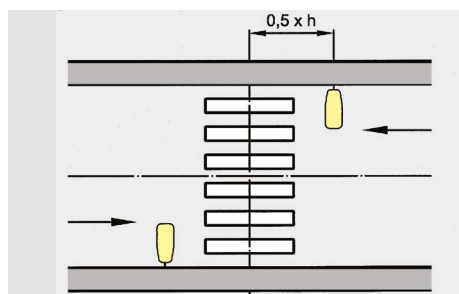

47... FUE



For pedestrian crossings or for object protection

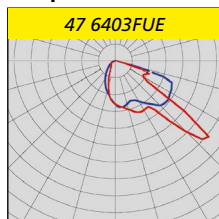

Applications:

Pedestrian crossings, object protection, fence, apron, area illumination ...

Design:

Asymmetrical light distribution. Major light beam crosswise to longitudinal axis of the luminaire with limited backward light beam.

colour temperature 4.000K (light colour 740)

47000 0448	47 6403FUE	140	22.030	157	10,3
------------	------------	-----	--------	-----	------

colour temperature 3.000K (light colour 730)

47000 0467	47 6403FUE 730	140	20.930	150	10,3
------------	----------------	-----	--------	-----	------

All light fittings also available with connected cable (see accessories in the data sheet).

Article No.	Type	Connected load [W]	Luminous flux [lm] ¹⁾	Luminous efficacy [lm/W] (up to)	Substitute for ca. *	Weight [kg] (without packing material)
-------------	------	--------------------	----------------------------------	----------------------------------	----------------------	--

48... / 47... VARIO



Design:

Same as type 48... / 47... but: With switch for for variable adjustment of the luminous flux in the luminaire.

Product highlights of the VARIO version:

- simple, fast, tool-free setting of the luminous flux on site, by means of integrated switch, can be changed at any time
- reduction in the variety of types



colour temperature 4.000K (light colour 740)

48001 0703	48 L50 VARIO	9 - 35	1.330 - 5.480	172	HST 35 - 2 x HST 70	7,5
48001 0750	48 L100 VARIO	16 - 70	2.730 - 11.140	177	HST 50 - HSE 150	7,6
47000 0366	47 L100 VARIO	16 - 70	2.760 - 11.360	180	HST 50 - HSE 150	10,2
47000 0364	47 L150 VARIO	24 - 106	4.130 - 16.850	173	2 x HME 80 - 2 x HME 250	10,2
47000 0365	47 L210 VARIO	32 - 140	5.460 - 22.030	171	2 x HST 70 - HME 400	10,3

colour temperature 3.000K (light colour 730)

48001 0701	48 L50 VARIO 730	9 - 35	1.260 - 5.210	163	HST 35 - 2 x HST 70	7,5
48001 0761	48 L100 VARIO 730	16 - 70	2.590 - 10.580	168	HST 50 - HSE 150	7,6
47000 0468	47 L100 VARIO 730	16 - 70	2.620 - 10.790	171	HST 50 - HSE 150	10,2
47000 0469	47 L150 VARIO 730	24 - 106	3.920 - 16.010	164	2 x HME 80 - 2 x HME 250	10,2
47000 0470	47 L210 VARIO 730	32 - 140	5.190 - 20.930	162	2 x HST 70 - HME 400	10,3

Factory setting L50: 18 W; replaces approx. HME 125, HST 70

Factory setting L100: 54 W; replaces approx. HME 250

1) possible setting range

Factory setting L150: 106 W; replaces approx. 2 x HME 250

Factory setting L210: 140 W; replaces approx. HME 400

* The given information is for rough orientation only. In each individual case a lighting calculation is necessary.

BestSelect – a selection of tried-and-tested SCHUCH luminaires for your everyday needs. More at: www.schuch.de/BestSelect



All light fittings also available with connected cable (see accessories in the data sheet).



Article no.	Type	Connected load [W]	Luminous flux [lm]	Luminous efficacy [lm/W]	Weight [kg] (without packing material)
-------------	------	--------------------	--------------------	--------------------------	--

RFL - Ready for Light Management Systems

Design:

Same as standard version 48... / 47..., but prepared for the subsequent use of a Light Management System. Integrated sockets allows retrofitting of Light Management components without tools.

Product highlights:

- standardised Zhaga Book 18 compliant sockets with D4i control gear
- subsequent use of a light management system possible at any time
- tool-free, quick assembly of the Light Management System components

RFL



48... / 47... RFL

with a socket on the top and bottom side of the luminaire

colour temperature 4.000K (light colour 740)

48004 0009	48 0803 RFLU	18	2.840	158	7,0
48004 0010	48 1603 RFLU	35	5.480	157	7,0
48004 0011	48 2403 RFLU	53	8.340	157	7,4
48004 0012	48 3203 RFLU	70	11.140	159	7,2
47002 0007	47 3203 RFLU	70	11.360	162	10,2
47002 0008	47 4803 RFLU	106	16.850	159	10,2
47002 0009	47 6403 RFLU	140	22.030	157	10,3

colour temperature 3.000K (light colour 730)

48004 0066	48 0803 730 RFLU	18	2.700	150	7,0
48004 0047	48 1603 730 RFLU	35	5.210	149	7,0
48004 0067	48 2403 730 RFLU	53	7.920	149	7,4
48004 0068	48 3203 730 RFLU	70	10.580	151	7,2
47002 0042	47 3203 730 RFLU	70	10.790	154	10,2
47002 0043	47 4803 730 RFLU	106	16.010	151	10,2
47002 0044	47 6403 730 RFLU	140	20.930	150	10,3

System accessories

Article No.	Type	
90546 9018	RFL BM/DS IR12	RFL motion sensor with light sensor, infrared (maximum light point height 12.0 m)
90546 9004	RFL BM/DS IR8	RFL motion sensor with light sensor, infrared (light point height max. 8.0 m)
90546 9000	RFL DS20	RFL control element with light sensor, standalone, 20 lx
90543 0001	LASC DONGLE USB + SOFT + LIZ	LIMAS Air SYNC USB dongle with software and licence
90546 9012	RFL LASC BM RAD10 MA MK2	RFL LIMAS Air SYNC light management controller (2.4 GHz mesh network) with motion sensor, radar (mounting height max. 10.0 m) for mast mounting with 2.0 m cable
90546 9011	RFL LASC BM RAD8	RFL LIMAS Air SYNC light management controller (2.4 GHz mesh network) with motion sensor, radar (max. light point height 8.0 m)
90546 9014	RFL LASC DS	RFL LIMAS Air SYNC light management controller (2.4 GHz mesh network) with light sensor
90546 9010	RFL LASC DS GPS SIM	RFL LIMAS Air SYNC light management controller (2.4 GHz mesh network) with light sensor, GPS antenna and eSIM

Other sensors, e.g. environmental sensors (fine dust, CO₂, weather station etc.) on request.

All light fittings also available with connected cable (see accessories in the data sheet).

Article no.	Type	Connected load [W]	Luminous flux [lm]	Luminous efficacy [lm/W]	Weight [kg] (without packing material)
-------------	------	--------------------	--------------------	--------------------------	--

NEW
47... DB



Applications:
Railway stations and platforms.

Deutsche Bahn listing:
DB Station & Service AG
List sheet number B 04.10.042

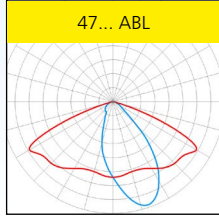

Product highlights:

- Deutsche Bahn listing
- easy installation, quick and convenient thanks to removable upper housing section
- economical operation, high light output
- future-proof by using standardised LED-modules (Zhaga)



colour temperature 4.000 K (light colour 740)

47000 3000	47 L29ABL CL DB	14	2.300	164	10,1
47000 3002	47 L34ABL CL DB	15	2.700	180	10,1

colour temperature 1.800 K (light colour 518)

47000 3012	47 L29ABL CL 518 DB	25	2.300	92	10,1
47000 3014	47 L34ABL CL 518 DB	30	2.700	90	10,1

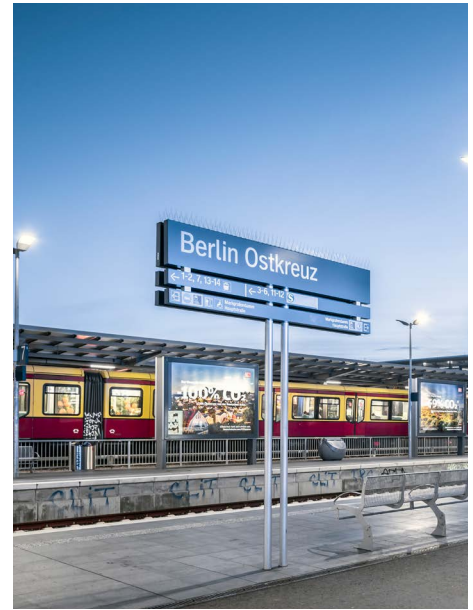

RZ 60/42 CAMINO



Pipe brackets for wall, pole and corner mounting, and post top brackets please see accessories in the data sheet.

Accessories / Spare Parts

Article No.	Type	
48002 9000	ABD 48 ESGW	cover, pane safety glass clear, for 48...
47001 9002	ABD 47 ESGW	cover, pane safety glass clear, for 47...
90306 0004	RZ 60/42 CAMINO	adapter for mast top Ø 42 mm, black

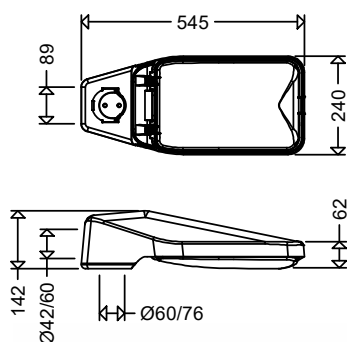

FILOS LED Outdoor Light Fitting with variable setting of the luminous flux Series 42... VARIO / 42AL... VARIO

Applications:

Residential-, through traffic streets, footpaths and cycle tracks, traffic-calmed areas, factory streets, car parks, gateways etc.

Design :

Housing: Glass fibre reinforced polyester resin, unpainted, or painting DB 702.

Housing for AL version: Die-cast aluminium, DB 702.

Diffuser: UV-stabilized PC, clear, hingeable and detachable.

Gear tray: Aluminium, with LED modul, optics and all electrical components in compact unit protected against accidental contact, isolating plug connection and

cable retainer.

Switch for setting the luminous flux of the luminaire.

Central closing: Stainless steel.

Light distribution: Asymmetrical wide beam.

Universal pole mounting device: Die-cast aluminium, for post top mounting Ø 60/76 mm and side entry mounting Ø 42/60 mm x 100 mm.

Inclination: Side entry mounting 0°, -5°, -10° and -15° depending on inclination of the cantilever.

Electrical design:

LED module: 4,000 K or 3,000 K, $R_a > 70$, service life $L_{95} > 100,000$ h, Zhaga compliant

ECG: 220-240 V, 50-60 Hz, Surge voltage resistance 10 kV, overload and short circuit protection.

Options:

- 2,200 K; light colour (722)
- 1,800 K; light colour (518)
- asymmetrical beam (A)
- asymmetrical extremely wide beam (RWX), for illuminating cycle paths
- special painting in RAL colours
- protection class I (SKI)
- seawater-resistant version
- for connection to a central power supply system (ZB)
- Ready for Lightmanagement System (RFL)

- dimming function via DALI-2 interface, compatible with LIMAS Line wired Light Management System (DIMD)
- power reduction with control phase (LR)
- power reduction without control phase (LA)
- constant luminous flux function (CL)
- additional overvoltage protection
- with backside light shielding (HA)
- inrush current limiter

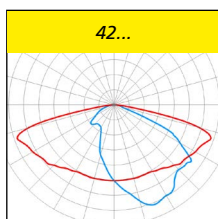

Product highlights:

- simple, fast, tool-free setting of the luminous flux on site, by means of integrated switch, can be changed at any time
- reduction in the variety of types
- economical storage due to standardisation
- long-life, robust housing made of glass fibre reinforced polyester (version 42... VARIO)
- long-life, corrosion-resistant die-cast aluminium housing with smooth surface without cooling fins (version 42AL... VARIO)
- integrated pressure compensation system prevents condensation in the interior
- protection of the LEDs against mechanical and electrostatic discharge due to sandwich-design of gear tray and cover
- quick mounting due to
 - tool-free opening of the luminaire by means of a central toggle clamp made of stainless steel
 - gear tray hingeable and detachable
 - removable multi-function cable entry enables pre-assembly of the connection cable
 - integrated universal pole mounting system (side entry mounting Ø 60 mm or post top mounting Ø 60/76 mm)
- homogeneous illumination due to the Multi-Layer-Technology
- eco-friendly, ULOR=0 %
- sustainable, control gear and LED-module replaceable by qualified personnel on-site
- future proof by using standardised LED-modules (Zhaga) and long-term availability of spare parts
- GreenLine luminaire, outstanding sustainable design (Version 42AL...)

! Properties, limitations and details for controlling LED-light fittings:

■ See "Technical Supplement"

All data are correct at the time of printing. Actual technical data can be found under www.schuch.de.

All light fittings also available with connected cable (see accessories in the data sheet).



All luminaires also available with luminous flux adjustment via app (NFC version).



unpainted



Painted DB 702

Article No.	Type	Connected load [W]	Luminous flux [lm] ¹⁾	Luminous efficacy [lm/W] (up to)	Substitute for ca. *	Weight [kg] (without packing material)
-------------	------	--------------------	----------------------------------	----------------------------------	----------------------	--

42... VARIO



Polyester housing

With switch for for variable adjustment of the luminous flux in the luminaire.

colour temperature 4.000K (light colour 740)

42008 0001	42 L50 VARIO	9 - 35	1.400 - 5.670	181	HST 35 - 2 x HST 70	4,0
42008 0028	42 L100 VARIO	16 - 70	2.820 - 11.130	185	HST 50 - HSE 150	4,1
42008 0501	42 L50 VARIO DB702	9 - 35	1.400 - 5.670	181	HST 35 - 2 x HST 70	4,0
42008 0500	42 L100 VARIO DB702	16 - 70	2.820 - 11.130	185	HST 50 - HSE 150	4,1

colour temperature 3.000K (light colour 730)

42008 0002	42 L50 VARIO 730	9 - 35	1.330 - 5.390	172	HST 35 - 2 x HST 70	4,0
42008 0029	42 L100 VARIO 730	16 - 70	2.680 - 10.570	176	HST 50 - HSE 150	4,1
42008 0502	42 L50 VARIO 730 DB702	9 - 35	1.330 - 5.390	172	HST 35 - 2 x HST 70	4,0
42008 0519	42 L100 VARIO 730 DB702	16 - 70	2.680 - 10.570	176	HST 50 - HSE 150	4,1

BestSelect – a selection of tried-and-tested SCHUCH luminaires for your everyday needs. More at: www.schuch.de/BestSelect



42AL... VARIO



Die-cast aluminium housing painted DB 702

With switch for for variable adjustment of the luminous flux in the luminaire.

colour temperature 4.000K (light colour 740)

42003 0001	42AL L50 VARIO	9 - 35	1.400 - 5.670	181	HST 35 - 2 x HST 70	4,9
42003 0031	42AL L100 VARIO	16 - 70	2.820 - 11.130	185	HST 50 - HSE 150	4,9

colour temperature 3.000K (light colour 730)

42003 0008	42AL L50 VARIO 730	9 - 35	1.330 - 5.390	172	HST 35 - 2 x HST 70	4,9
42003 0030	42AL L100 VARIO 730	16 - 70	2.680 - 10.570	176	HST 50 - HSE 150	4,9

Factory setting L50: 18 W; replaces approx. ca. HME 125, HST 70

1) possible setting range

Factory setting L100: 54 W; replaces approx. HME 250

* The given information is for rough orientation only. In each individual case a lighting calculation is necessary.

Welded Aluminium Standard Pole Arm Carrier Series 4871



4871 RAL 7035



4871 DB 702

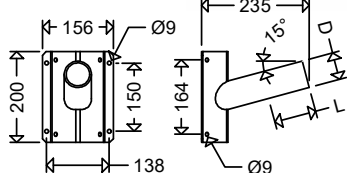

Applications:

For mounting outdoor light fittings on flat walls and corners of buildings.

Design:

Aluminium plate 4 mm thick, powder coated grey

(RAL 7035) or DB 702, with eight fixing holes \varnothing 9mm and pole arm \varnothing 60 mm (100 mm long).

Options:

Special painting in RAL colours (SL)

4871

Article no.	Type	D	L	Weight ca. [kg]
48700 0002	4871 RAL7035	60	100	0,7
48700 0506	4871 DB702	60	100	0,7

BestSelect – a selection of tried-and-tested SCHUCH articles for your everyday needs. More at: www.schuch.de/BestSelect

Accessories / Spare Parts

Article no.	Type	
42001 9003	ABD 42 PC	cover, diffuser PC clear, UV stabilized, clear, for 42...

Pipe brackets for wall, pole and corner mounting, and post top brackets please see end of this chapter.

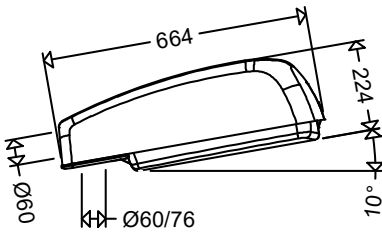
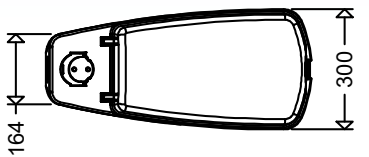

Compact unit with all electrical components, detachable without tools.

LUCA Modern LED Outdoor Light Fitting with variable setting of the luminous flux and Multi-Purpose Mounting System Series 46... G2 VARIO

Applications:

Residential streets, by-roads and thoroughfares, walkways and bicycle lanes, traffic-calmed zones, factory streets in industrial plants, car parks, entrances and exits etc.

Design:

Housing: Glass fibre reinforced polyester resin with UV resistant coating, integrated pressure compensation system.

Diffuser: UV stabilized PC, clear, hinged and detachable.

Gear tray: Aluminium, with LED module, optics and all electrical components as a compact unit. Unit connected to the clear cover in a (sandwich construction), disconnectable plug-in connection and

strain relief.

Switch for setting the luminous flux of the luminaire.

Fasteners: Stainless steel.

Light distribution: Asymmetrical wide beam

Universal pole mounting device: Die-cast aluminium, for post top mounting Ø 60/76 mm (inclination: 10 °) and side entry mounting Ø 60 mm. For side entry mounting Ø 42 mm, separate reducing accessories are required (see accessories / spare parts).

Inclination: Side entry mounting 0°, -5°, -10° and -15° depending on inclination of the cantilever.

Electrical design:

LED module: 4,000 K or 3,000 K, $R_a > 70$, service life $L_{95} > 100,000$ h, Zhaga compliant

ECG: 220-240 V, 50-60 Hz, Surge voltage resistance 10 kV, overload and short circuit protection.

Options:

- 2,200 K; light colour (722)
- 1,800 K; light colour (518)
- asymmetrical beam (A)
- asymmetrical extremely wide beam (RWX), for illuminating cycle paths
- asymmetrical wide beam, low glare (ABL)
- Aluminium version (AL)
- special painting in RAL colours
- protection class I (SKI)
- seawater-resistant version
- for connection to a central power supply system (ZB)

- Ready for Lightmanagement System (RFL)
- dimming function via DALI-2 interface, compatible with LIMAS Line wired Light Management System (DIMD)
- power reduction with control phase (LR)
- power reduction without control phase (LA)
- constant luminous flux function (CL)
- additional overvoltage protection
- with backside light shielding (HA)
- inrush current limiter

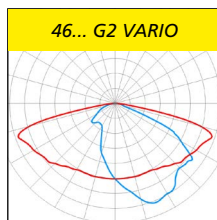

Product highlights:

- simple, fast, tool-free setting of the luminous flux on site, by means of integrated switch, can be changed at any time
- reduction in the variety of types
- economical storage due to standardisation
- long-life housing polyester housing with UV and weather-resistant protective coating
- integrated pressure compensation system prevents condensation in the interior
- protection of the LEDs against mechanical and electrostatic discharge due to sandwich-design of gear tray and cover
- quick mounting due to
 - tool-free opening of the luminaire by means of a central toggle clamp made of stainless steel
 - gear tray hingeable and detachable
 - removable multi-function cable entry enables pre-assembly of the connection cable
 - integrated universal pole mounting system (side entry mounting Ø 60 mm or post top mounting Ø 60/76 mm)
- homogeneous illumination due to the Multi-Layer-Technology
- sustainable, control gear and LED-module replaceable by qualified personnel on-site
- future proof by using standardised LED-modules (Zhaga) and long-term availability of spare parts

! Properties, limitations and details for controlling LED-light fittings:

■ See "Technical Supplement"

All data are correct at the time of printing. Actual technical data can be found under www.schuch.de.

All light fittings also available with connected cable (see accessories in the data sheet).



All luminaires also available with luminous flux adjustment via app (NFC version).

Article No.	Type	Connected load [W]	Luminous flux [lm] ¹⁾	Luminous efficacy [lm/W] (up to)	Substitute for ca. *	Weight [kg] (without packing material)
-------------	------	--------------------	----------------------------------	----------------------------------	----------------------	--

46... G2 VARIO

IP65



Wind load area A = 0,11

With switch for for variable adjustment of the luminous flux in the luminaire.

colour temperature 4.000K (light colour 740)

46007 0001	46 L50 VARIO	9 - 35	1.420 - 5.840	184	HST 35 - 2 x HST 70	5,9
46007 0002	46 L100 VARIO	16 - 70	2.910 - 11.720	188	HST 50 - HSE 150	6,0

colour temperature 3.000K (light colour 730)

46007 0003	46 L50 VARIO 730	9 - 35	1.350 - 5.550	174	HST 35 - 2 x HST 70	5,9
46007 0004	46 L100 VARIO 730	16 - 70	2.760 - 11.130	178	HST 50 - HSE 150	6,0

Factory setting L50: 18 W; replaces approx. HME 125, HST 70

1) possible setting range

Factory setting L100: 54 W; replaces approx. HME 250

* The given information is for rough orientation only. In each individual case a lighting calculation is necessary.



RZ 60/42 LUCA



Pipe brackets for wall, pole and corner mounting, and post top brackets please see accessories in the data sheet.

Accessories / Spare Parts

Article no.	Type	
46001 9003	ABD 46 G2 PC K	cover, diffuser PC clear, UV stabilized, for 46...
90306 0003	RZ 60/42 LUCA	adapter for mast top Ø 42 mm, black

Subject to technical changes, misprints and errors.

NEW

LED Outdoor Light Fitting for low track gauges Series 131... nGgB

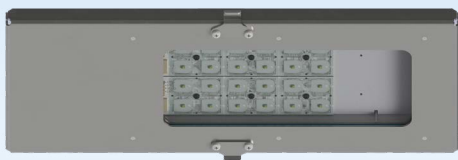

Applications:

Deutsche Bahn railway tracks and industrial railway tracks with DB requirements.

Deutsche Bahn listing:

DB Station & Service AG
List sheet number B 04.10.042

Design:

Housing: Stainless steel, powder-coated in DB 702

Diffuser: Frosted single-pane safety glass

Light distribution: Asymmetrical beam

Connection: FastConnect quick connection plug

Electrical design:

LED module: 4,000 K, $R_a > 80$, service life $L_{95} > 100,000$ h

ECG: 24V DC constant voltage

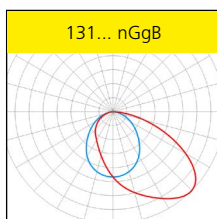
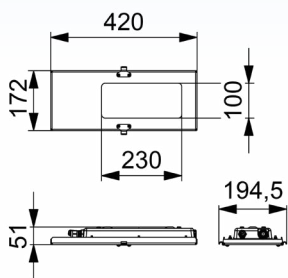

Article no.	Type	Connected load [W]	Luminous flux [lm]	Luminous efficacy [lm/W]	Weight [kg] (without packing material)
-------------	------	--------------------	--------------------	--------------------------	---

131 L09 nGgB DB



Product highlights:

- Deutsche Bahn listing
- FastConnect quick connection plug
- prepared for mounting with clamp fasteners
- ECG accessible at ground level in the pole
- no light emission into the upper half-space (Dark Sky)
- sustainable, components replaceable
- future proof by using Zhaga-compliant LED-modules



colour temperature 4.000 K (light colour 840)

13102 0001	131 L09 nGgB DB	7,8	877	112	2,4
------------	-----------------	-----	-----	-----	-----

ECG unit

90283 0020	EVG 2 131 L09 nGgB DB	EVG unit for connecting 2 luminaires 131 L09 nGgB DB
------------	-----------------------	--



Outdoor
Light Fittings

! Properties, limitations and details for controlling LED-light fittings:
■ See "Technical Supplement"

All data are correct at the time of printing. Actual technical data can be found under www.schuch.de.



PENDO Rope Supported LED Light Fitting Series 59 ... / 49...

Applications:

Residential, service, secondary, thoroughfare, collecting and main roads, etc.

Design:

Housing: Die-cast aluminium, 2-parts, powder coated in DB 702.

Lower section with LED-Module, optics, glass cover and ECG, tool-free hingeable and detachable.

Upper section with bracket, adjustment of inclination, cable entry with pressure compensation system.

Glass cover: Flat safety glass, impact resistance IK10.

Light distribution: Symmetrical wide beam.

Connecting terminal: With plug-in connection in junction box between upper and lower section, tool-free separation of upper and lower section.

Mounting: Stainless steel. Turnable (all directions) and adjustable by 15°, mountable on ropes of 6 - 12 mm diameter.

Electrical design:

LED module: 4,000 K or 3,000 K, $R_a > 70$, service life $L_{95} > 100,000$ h, Zhaga compliant

ECG: 220-240 V, 50-60 Hz, Surge voltage resistance 10 kV, overload and short circuit protection.

Options:

- 2,200 K; light colour (722)
- 1,800 K; light colour (518)
- special painting in RAL colours
- protection class I (SKI)
- seawater-resistant version
- dimming function via DALI-2 interface, compatible with LIMAS Line wired Light Management System (DIMD)
- power reduction with control phase (LR)
- power reduction without control phase (LA)
- constant luminous flux function (CL)
- additional overvoltage protection
- 3-point supporting bracket
- inrush current limiter

59...

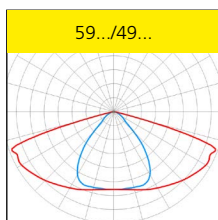
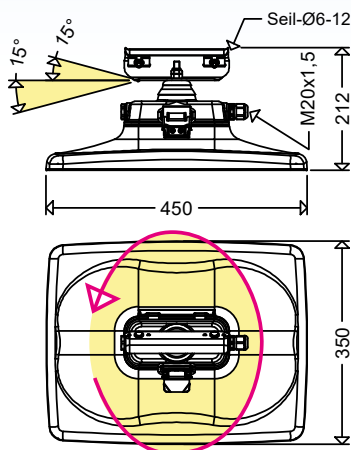

49...

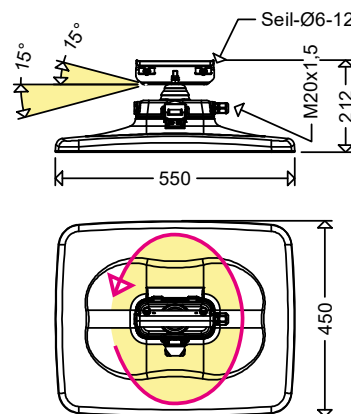

Product highlights:

- long-lasting, corrosion resistant die-cast aluminium housing with plain surface.
- excellent thermal management, long service life
- integrated pressure compensation system prevents condensation in the interior
- time- and cost-saving mounting in 2 steps due to tool-free removable lower part of the housing:
1st step: Hinge upper part with bracket onto the rope and connect the mains
2nd step: Hinge lower part, connect isolating plug, shut the housing and close. **READY**
- universal usage on cross- and longitudinal ropes, inclined ropes or 3-point rope supports (see accessories) due to all-side rotatable and up to 15° inclinable stainless steel bracket
- tool-free disconnection (also electrical!) of the lower part from the upper part allows a comfortable replacement of the components at site or in the workshop
- homogeneous illumination due to the Multi-Layer-Technology
- eco-friendly, no light emission into the upper half-space, $ULOR=0$
- versions dimmable to 10% and with color temperature up to 3,000 K comply with **Dark Sky requirements**
- sustainable, control gear and LED-module replaceable by qualified personnel on-site
- future proof by using standardised LED-modules (Zhaga) and long-term availability of spare parts
- GreenLine luminaire, outstanding sustainable design

! Properties, limitations and details for controlling LED-light fittings:

■ See "Technical Supplement"

All data are correct at the time of printing. Actual technical data can be found under www.schuch.de.

All light fittings also available with connected cable (see accessories in the data sheet).

Article no.	Type	Connected load [W]	Luminous flux [lm]	Luminous efficacy [lm/W]	Weight [kg] (without packing material)
-------------	------	--------------------	--------------------	--------------------------	--

59... / 49...

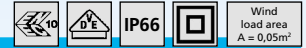

colour temperature 4.000K (light colour 740)

59001 0069	59 1601	17	3.210	189	6,6
59001 0070	59 1602	25	4.480	179	6,6
59001 0071	59 1603	35	6.070	173	6,6
59001 0072	59 3201	34	6.420	189	7,0
59001 0036	59 3202	50	8.950	179	7,0
59001 0051	59 3203	70	12.080	173	7,0
49000 0005	49 6401	69	12.580	182	11,8
49000 0006	49 6402	99	17.520	177	11,8
49000 0002	49 6403	140	23.570	168	11,8

colour temperature 3.000K (light colour 730)

59001 0063	59 1601 730	17	3.050	179	6,6
59001 0066	59 1602 730	25	4.260	170	6,6
59001 0073	59 1603 730	35	5.770	165	6,6
59001 0074	59 3201 730	34	6.100	179	7,0
59001 0075	59 3202 730	50	8.500	170	7,0
59001 0076	59 3203 730	70	11.480	164	7,0
49000 0069	49 6401 730	69	11.950	173	11,8
49000 0007	49 6402 730	99	16.640	168	11,8
49000 0070	49 6403 730	140	22.390	160	11,8

Article No.	Type	Connected load [W]	Luminous flux [lm] ¹⁾	Luminous efficacy [lm/W] (up to)	Substitute for ca. *	Weight [kg] (without packing material)
-------------	------	--------------------	----------------------------------	----------------------------------	----------------------	--

59... / 49... VARIO



Design:

Same as type 59... / 49... but: With switch for for variable adjustment of the luminous flux in the luminaire.

Product highlights of the VARIO version:

- simple, fast, tool-free setting of the luminous flux on site, by means of integrated switch, can be changed at any time
- reduction in the variety of types



colour temperature 4.000K (light colour 740)

59005 0005	59 L50 VARIO	9 - 35	1.470 - 6.070	190	HST 35 - 2 x HST 70	6,6
59005 0006	59 L100 VARIO	16 - 70	2.950 - 12.080	191	HST 50 - HSE 150	7,0
49004 0001	49 L210 VARIO	32 - 140	5.790 - 23.570	181	2 x HST 70 - HME 400	11,8

colour temperature 3.000K (light colour 730)

59005 0007	59 L50 VARIO 730	9 - 35	1.400 - 5.770	181	HST 35 - 2 x HST 70	6,6
59005 0008	59 L100 VARIO 730	16 - 70	2.800 - 11.480	182	HST 50 - HSE 150	7,0
49004 0002	49 L210 VARIO 730	32 - 140	5.500 - 22.390	180	2 x HST 70 - HME 400	11,8

Factory setting L50: 18 W; replaces approx. HME 125, HST 70
 Factory setting L100: 50 W; replaces approx. HME 250

Factory setting L210: 140 W; replaces approx. HME 400

1) possible setting range

* The given information is for rough orientation only. In each individual case a lighting calculation is necessary.



! All light fittings also available with connected cable (see accessories in the data sheet).

Article no.	Type	Connected load [W]	Luminous flux [lm]	Luminous efficacy [lm/W]	Weight [kg] (without packing material)
-------------	------	--------------------	--------------------	--------------------------	--

RFL - Ready for Light Management Systems

Design:

Same as standard version 59... / 49... but prepared for the subsequent use of a Light Management System. Integrated sockets allows retrofitting of Light Management components without tools.

Product highlights:

- standardised Zhaga Book 18 compliant sockets with D4i control gear
- subsequent use of a light management system possible at any time
- tool-free, quick assembly of the Light Management System components



59... / 49... RFL



with a socket on the top side of the luminaire

colour temperature 4.000K (light colour 740)

59002 0005	59 1603 RFLO	35	6.070	173	6,6
59002 0006	59 3203 RFLO	70	12.080	173	7,0
49002 0005	49 6402 RFLO	99	17.520	177	11,8
49002 0006	49 6403 RFLO	140	23.570	168	11,8

colour temperature 3.000K (light colour 730)

59002 0007	59 1603 730 RFLO	35	5.770	165	6,6
59002 0008	59 3203 730 RFLO	70	11.480	164	7,0
49002 0007	49 6402 730 RFLO	99	16.640	168	11,8
49002 0008	49 6403 730 RFLO	140	22.390	160	11,8

System accessories

Article No.	Type	
90546 9000	RFL DS20	RFL control element with light sensor, standalone, 20 lx
90543 0001	LASC DONGLE USB + SOFT + LIZ	LIMAS Air SYNC USB dongle with software and licence
90546 9014	RFL LASC DS	RFL LIMAS Air SYNC light management controller (2.4 GHz mesh network) with light sensor
90546 9010	RFL LASC DS GPS SIM	RFL LIMAS Air SYNC light management controller (2.4 GHz mesh network) with light sensor, GPS antenna and eSIM

Other sensors, e.g. environmental sensors (fine dust, CO₂, weather station etc.) on request.

Optionally also with 3-point mounting



Accessories / Spare Parts

Article no.	Type	
49001 9003	ABD 59 ESGW	cover, pane safety glass clear, for 59...
49001 9001	ABD 49 ESGW	cover, pane safety glass clear, for 49...

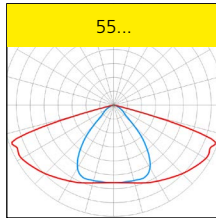
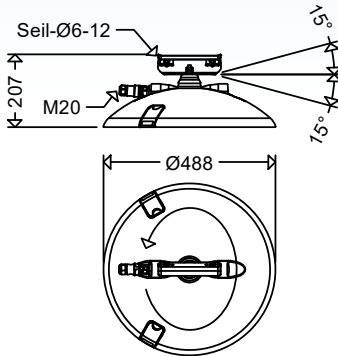

REDONDO Rope Supported LED Light Fitting Series 55...

Applications:

Residential and service roads, by-roads and main roads etc.

Design:

Housing: Die-cast aluminium, powder coated in DB 702 with carrying bracket, inclination adjustment and pressure compensation system.

Glass cover: Flat safety glass, hinged, can be opened without tools via 2 toggle levers, impact resistance IK09.

Electrical components: Wired ready for installation, disconnect plug-in connector

to the mains connection terminal, LED module and ECG unit can be replaced without tools.

Light distribution: Symmetrical wide beam.

Connection: Quick connection plug (**FastConnect**), plug mounted to the housing, socket included. Wired ready for connection.

Mounting: Stainless steel. Turnable (all directions) and adjustable by 15 °, mountable on ropes of 6 - 12 mm diameter.

Electrical design:

LED module: 4,000 K or 3,000 K, $R_a > 70$, service life $L_{95} > 100,000$ h, Zhaga compliant

ECG: 220-240 V, 50-60 Hz, Surge voltage resistance 10 kV, overload and short circuit protection.

Options:

- 2,200 K; light colour (722)
- 1,800 K; light colour (518)
- special painting in RAL colours
- protection class I (SKI)
- seawater-resistant version
- variable adjustable luminous flux via app (NFC)
- dimming function via DALI-2 interface, compatible with LIMAS Line wired Light Management System (DIMD)
- power reduction with control phase (LR)
- power reduction without control phase (LA)
- constant luminous flux function (CL)
- additional overvoltage protection
- 3-point supporting bracket
- inrush current limiter

Product highlights:

- long-lasting, corrosion resistant die-cast aluminium housing with plain surface.
- integrated pressure compensation system prevents condensation in the interior
- can be opened without tools
- fast mains connection thanks to integrated FastConnect quick connection plug
- tool-free ECG replacement
- tool-free LED module replacement
- universal usage on cross- and longitudinal ropes, inclined ropes or 3-point rope supports (see accessories) due to all-side rotatable and up to 15° inclinable stainless steel bracket
- homogeneous illumination due to the Multi-Layer-Technology
- eco-friendly, no light emission into the upper half-space, $ULOR=0$
- versions dimmable to 10% and with color temperature up to 3,000 K comply with Dark Sky requirements
- sustainable, control gear and LED-module replaceable by qualified personnel on-site
- future proof by using standardised LED-modules (Zhaga) and long-term availability of spare parts
- GreenLine luminaire, outstanding sustainable design

! Properties, limitations and details for controlling LED-light fittings:

■ See "Technical Supplement"

All data are correct at the time of printing. Actual technical data can be found under www.schuch.de.

All light fittings also available with connected cable (see accessories in the data sheet).

Article no.	Type	Connected load [W]	Luminous flux [lm]	Luminous efficacy [lm/W]	Weight [kg] (without packing material)
-------------	------	--------------------	--------------------	--------------------------	--

55...

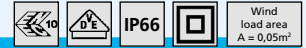

colour temperature 4.000K (light colour 740)

55000 0001	55 1601 FC	17	3.210	189	7,1
55000 0002	55 1602 FC	25	4.480	179	7,1
55000 0003	55 1603 FC	35	6.070	173	7,1
55000 0004	55 3201 FC	34	6.420	189	7,2
55000 0005	55 3202 FC	50	8.950	179	7,2
55000 0006	55 3203 FC	70	12.080	173	7,2
55000 0007	55 4801 FC	52	9.060	174	7,4
55000 0008	55 4802 FC	75	12.550	167	7,4
55000 0009	55 4803 FC	106	16.730	158	7,4
55000 0010	55 6401 FC	69	12.580	182	7,5
55000 0011	55 6402 FC	99	17.520	177	7,5

colour temperature 3.000K (light colour 730)

55000 0012	55 1601 730 FC	17	3.050	179	7,1
55000 0013	55 1602 730 FC	25	4.260	170	7,1
55000 0014	55 1603 730 FC	35	5.770	165	7,1
55000 0015	55 3201 730 FC	34	6.100	179	7,2
55000 0016	55 3202 730 FC	50	8.500	170	7,2
55000 0017	55 3203 730 FC	70	11.480	164	7,2
55000 0018	55 4801 730 FC	52	8.610	166	7,4
55000 0019	55 4802 730 FC	75	11.920	159	7,4
55000 0020	55 4803 730 FC	106	15.890	150	7,4
55000 0021	55 6401 730 FC	69	11.950	173	7,5
55000 0022	55 6402 730 FC	99	16.640	168	7,5



All luminaires also available with luminous flux adjustment via app (NFC version).

Article No.	Type	Connected load [W]	Luminous flux [lm] ¹⁾	Luminous efficacy [lm/W] (up to)	Substitute for ca. *	Weight [kg] (without packing material)
-------------	------	--------------------	----------------------------------	----------------------------------	----------------------	--

55... VARIO



Design:

Same as type 55... but: With switch for for variable adjustment of the luminous flux in the luminaire.

Product highlights of the VARIO version:

- simple, fast, tool-free setting of the luminous flux on site, by means of integrated switch, can be changed at any time
- reduction in the variety of types



colour temperature 4.000K (light colour 740)

55002 0001	55 L50 VARIO FC	9 - 35	1.470 - 6.070	190	HST 35 - 2 x HST 70	7,1
55002 0003	55 L100 VARIO FC	16 - 70	2.950 - 12.080	191	HST 50 - HSE 150	7,2
55002 0005	55 L150 VARIO FC	24 - 106	4.190 - 16.730	175	2 x HME 80 - 2 x HME 250	7,4

colour temperature 3.000K (light colour 730)

55002 0002	55 L50 VARIO 730 FC	9 - 35	1.400 - 5.770	181	HST 35 - 2 x HST 70	7,1
55002 0004	55 L100 VARIO 730 FC	16 - 70	2.800 - 11.480	182	HST 50 - HSE 150	7,2
55002 0006	55 L150 VARIO 730 FC	24 - 106	3.980 - 15.890	166	2 x HME 80 - 2 x HME 250	7,4

Factory setting L50: 18 W; replaces approx. HME 125, HST 70

Factory setting L100: 54 W; replaces approx. HME 250

Factory setting L150: 106 W; replaces approx. 2 x HME 250

* The given information is for rough orientation only. In each individual case a lighting calculation is necessary.

1) possible setting range

All light fittings also available with connected cable (see accessories in the data sheet).

Article no.	Type	Connected load [W]	Luminous flux [lm]	Luminous efficacy [lm/W]	Weight [kg] (without packing material)
-------------	------	--------------------	--------------------	--------------------------	--

RFL - Ready for Light Management Systems

Design:

Same as standard version 55... but prepared for the subsequent use of a Light Management System. Integrated sockets allows retrofitting of Light Management components without tools.

Product highlights:

- standardised Zhaga Book 18 compliant sockets with D4i control gear
- subsequent use of a light management system possible at any time
- tool-free, quick assembly of the Light Management System components



55... RFL



with a socket on the top side of the luminaire

colour temperature 4.000K (light colour 740)

55001 0001	55 1603 FC RFLO	35	6.070	173	7,1
55001 0003	55 3203 FC RFLO	70	12.080	173	7,2
55001 0005	55 4803 FC RFLO	106	16.730	158	7,4

colour temperature 3.000K (light colour 730)

55001 0002	55 1603 730 FC RFLO	35	5.770	165	7,1
55001 0004	55 3203 730 FC RFLO	70	11.480	164	7,2
55001 0006	55 4803 730 FC RFLO	106	15.890	150	7,4

System accessories

Article No.	Type	
90546 9000	RFL DS20	RFL control element with light sensor, standalone, 20 lx
90543 0001	LASC DONGLE USB + SOFT + LIZ	LIMAS Air SYNC USB dongle with software and licence
90546 9014	RFL LASC DS	RFL LIMAS Air SYNC light management controller (2.4 GHz mesh network) with light sensor
90546 9010	RFL LASC DS GPS SIM	RFL LIMAS Air SYNC light management controller (2.4 GHz mesh network) with light sensor, GPS antenna and eSIM

Other sensors, e.g. environmental sensors (fine dust, CO₂, weather station etc.) on request.

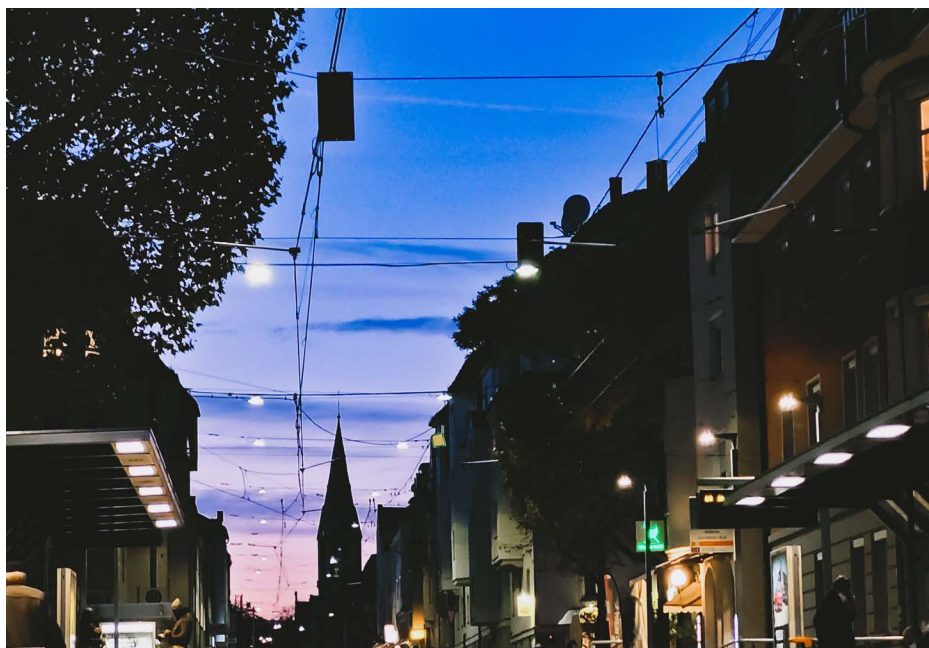

Outdoor
Light Fittings

Accessories / Spare Parts

Article no.	Type	
55010 0001	ABD 55 ESGW	cover, pane safety glass clear, for 55...

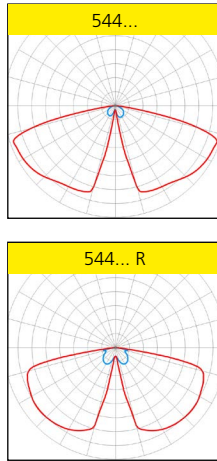
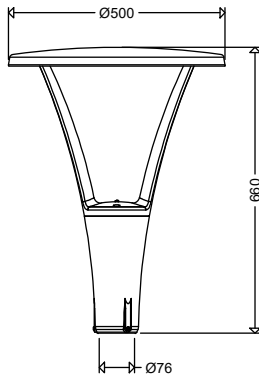

KONIC LED Pole-Top Light Fitting Series 544... G2

Applications:

544... AB:

Residential areas, residential and side streets, low traffic areas, footpaths and cycle tracks etc.

544... R:

Promenades, public parks, pedestrian areas etc.

Design:

Housing: Die-cast aluminium, threepart, powder coated DB 702.

Lower section with electrical components, cable entry, plug-type device and cable retainer for connection cable.

Connecting struts with cable feed-through.

Upper part with LED-modules and optics.

Cover: flat safety glass, impact resistance IK09

Light distribution: Asymmetrical wide beam or symmetrical circular beam (R).

Mounting system: 3 non-corrosive steel locking screws serve for fixation on straight pole end Ø 76 mm.

Adapter (RZ 1) for pole end Ø 60 mm (see accessories / spare parts).

Electrical design:

LED module: 4,000 K or 3,000 K, $R_a > 70$, service life $L_{95} > 100,000$ h, Zhaga compliant

ECG: 220-240 V, 50-60 Hz, Surge voltage resistance 10 kV, overload and short circuit protection.

Options:

- 2,200 K; light colour (722)
- 1,800 K; light colour (518)
- asymmetrical extremely wide beam (RWX), for illuminating cycle paths
- special painting in RAL colours
- protection class I (SKI)
- seawater-resistant version
- for connection to a central power supply system (ZB)
- variable adjustable luminous flux via APP (NFC)

- dimming function via DALI-2 interface, compatible with LIMAS Line wired Light Management System (DIMD)
- power reduction with control phase (LR)
- power reduction without control phase (LA)
- constant luminous flux function (CL)
- with backside light shielding (HA)



Product highlights:

- long-lasting, corrosion resistant aluminium housing with plain surface
- excellent thermal management, long service life
- easy to install, to maintain and to retrofit
 - removable upper part of the housing allows time- and cost-saving mounting, mains connection terminal within the supporting section
 - fast maintenance due to an easily interchangeable gear-tray system (modular concept) within the supporting section, ECG can be replaced on-site
- homogeneous illumination due to the Multi-Layer-Technology
- BlackEdition, ULOR=0 %
- eco-friendly, versions dimmable to 10% with luminous fluxes up to 2,000 lm and with color temperature up to 3,000 K comply with Dark Sky requirements
- sustainable, control gear and LED-module replaceable by qualified personnel on-site
- future proof by using standardised LED-modules (Zhaga) and long-term availability of spare parts

Properties, limitations and details for controlling LED-light fittings:

See "Technical Supplement"

All data are correct at the time of printing. Actual technical data can be found under www.schuch.de.

All light fittings also available with connected cable (see accessories in the data sheet).

Article No.	Type	Connected load [W]	Luminous flux [lm]	Luminous efficacy [lm/W]	Weight [kg] (without packing material)
-------------	------	--------------------	--------------------	--------------------------	--

544... G2



asymmetrical wide beam

colour temperature 4.000K (light colour 740)

54404 0001	544 0801 G2	9	1.410	157	9,5
54404 0002	544 0802 G2	13	1.970	152	9,5
54404 0003	544 0803 G2	18	2.680	149	9,5
54404 0004	544 1601 G2	17	2.730	161	9,6
54404 0005	544 1602 G2	25	3.820	153	9,6
54404 0006	544 1603 G2	35	5.180	148	9,6
54404 0007	544 2401 G2	26	4.110	158	9,7
54404 0008	544 2402 G2	37	5.730	155	9,7
54404 0009	544 2403 G2	53	7.750	146	9,7

colour temperature 3.000K (light colour 730)

54404 0010	544 0801 G2 730	9	1.340	149	9,5
54404 0011	544 0802 G2 730	13	1.870	144	9,5
54404 0012	544 0803 G2 730	18	2.550	142	9,5
54404 0013	544 1601 G2 730	17	2.590	152	9,6
54404 0014	544 1602 G2 730	25	3.630	145	9,6
54404 0015	544 1603 G2 730	35	4.920	141	9,6
54404 0016	544 2401 G2 730	26	3.900	150	9,7
54404 0017	544 2402 G2 730	37	5.440	147	9,7
54404 0018	544 2403 G2 730	53	7.360	139	9,7

544... R G2



symmetrical circular beam

colour temperature 4.000K (light colour 740)

54404 0019	544 0801R G2	9	1.410	157	9,5
54404 0020	544 0802R G2	13	1.970	152	9,5
54404 0021	544 0803R G2	18	2.680	149	9,5
54404 0022	544 1601R G2	17	2.730	161	9,6
54404 0023	544 1602R G2	25	3.820	153	9,6
54404 0024	544 1603R G2	35	5.180	148	9,6
54404 0025	544 2401R G2	26	4.110	158	9,7
54404 0026	544 2402R G2	37	5.730	155	9,7
54404 0027	544 2403R G2	53	7.750	146	9,7

colour temperature 3.000K (light colour 730)

54404 0028	544 0801R G2 730	9	1.340	149	9,5
54404 0029	544 0802R G2 730	13	1.870	144	9,5
54404 0030	544 0803R G2 730	18	2.550	142	9,5
54404 0031	544 1601R G2 730	17	2.590	152	9,6
54404 0032	544 1602R G2 730	25	3.630	145	9,6
54404 0033	544 1603R G2 730	35	4.920	141	9,6
54404 0034	544 2401R G2 730	26	3.900	150	9,7
54404 0035	544 2402R G2 730	37	5.440	147	9,7
54404 0036	544 2403R G2 730	53	7.360	139	9,7



All light fittings also available with connected cable (see accessories in the data sheet).



All luminaires also available with luminous flux adjustment via app (NFC version).

Article No.	Type	Connected load [W]	Luminous flux [lm] ¹⁾	Luminous efficacy [lm/W] (up to)	Substitute for ca. *	Weight [kg] (without packing material)
-------------	------	--------------------	----------------------------------	----------------------------------	----------------------	--

544... G2 VARIO



Design:

Same as type 544... G2 but: With switch for for variable adjustment of the luminous flux in the luminaire.

Product highlights of the VARIO version:

- simple, fast, tool-free setting of the luminous flux on site, by means of integrated switch, can be changed at any time
- reduction in the variety of types



asymmetrical wide beam

colour temperature 3.000K (light colour 730)

54405 0001	544 L25 G2 VARIO	5 - 18	640 - 2.680	157	HST 35 - HST 50	9,5
54405 0002	544 L50 G2 VARIO	9 - 35	1.250 - 5.180	162	HST 35 - 2 x HST 70	9,6
54405 0003	544 L100 G2 VARIO	16 - 70	2.460 - 10.080	160	HST 50 - HSE 150	9,8

colour temperature 3.000K (light colour 730)

54405 0004	544 L25 G2 VARIO 730	5 - 18	610 - 2.550	149	HST 35 - HST 50	9,5
54405 0005	544 L50 G2 VARIO 730	9 - 35	1.190 - 4.920	154	HST 35 - 2 x HST 70	9,6
54405 0006	544 L100 G2 VARIO 730	16 - 70	2.340 - 9.580	152	HST 50 - HSE 150	9,8

symmetrical circular beam

colour temperature 4.000K (light colour 740)

54405 0007	544 L25R G2 VARIO	5 - 18	640 - 2.680	157	HST 35 - HST 50	9,5
54405 0008	544 L50R G2 VARIO	9 - 35	1.250 - 5.180	162	HST 35 - 2 x HST 70	9,6
54405 0009	544 L100R G2 VARIO	16 - 70	2.460 - 10.080	160	HST 50 - HSE 150	9,8

colour temperature 3.000K (light colour 730)

54405 0010	544 L25R G2 VARIO 730	5 - 18	610 - 2.550	149	HST 35 - HST 50	9,5
54405 0011	544 L50R G2 VARIO 730	9 - 35	1.190 - 4.920	154	HST 35 - 2 x HST 70	9,6
54405 0012	544 L100R G2 VARIO 730	16 - 70	2.340 - 9.580	152	HST 50 - HSE 150	9,8

Factory setting L25: 18 W; replaces approx. HME 80, HST 50
 Factory setting L50: 18 W; replaces approx. HME 125, HST 70
 1) possible setting range

Factory setting L100: 54 W; replaces approx. HME 250

* The given information is for rough orientation only. In each individual case a lighting calculation is necessary.



All light fittings also available with connected cable (see accessories in the data sheet).

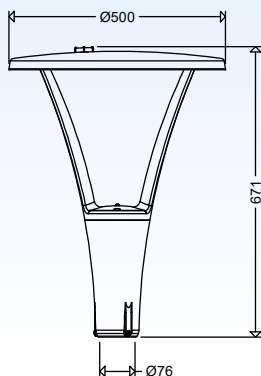

Article No.	Type	Connected load [W]	Luminous flux [lm]	Luminous efficacy [lm/W]	Weight [kg] (without packing material)
-------------	------	--------------------	--------------------	--------------------------	--

RFL - Ready for Light Management Systems

Design:

Same as standard version 544... G2 but prepared for the subsequent use of a Light Management System. Integrated sockets allows retrofitting of Light Management components without tools.

Product highlights:

- standardised Zhaga Book 18 compliant sockets with D4i control gear
- subsequent use of a light management system possible at any time
- tool-free, quick assembly of the Light Management System components

RFL



IP65



Wind load area A = 0,07m²

544... G2 RFL

with a socket on the top side of the luminaire
asymmetrical wide beam

colour temperature 4.000K (light colour 740)

54406 0001	544 0803 G2 RFLO	18	2.680	149	9,5
54406 0002	544 1603 G2 RFLO	35	5.180	148	9,6
54406 0003	544 2403 G2 RFLO	53	7.750	146	9,7

colour temperature 3.000K (light colour 730)

54406 0004	544 0803 G2 730 RFLO	18	2.550	142	9,5
54406 0005	544 1603 G2 730 RFLO	35	4.920	141	9,6
54406 0006	544 2403 G2 730 RFLO	53	7.360	139	9,7

IP65



Wind load area A = 0,07m²

544... R G2 RFL

with a socket on the top side of the luminaire
symmetrical circular beam

colour temperature 4.000K (light colour 740)

54406 0007	544 0803R G2 RFLO	18	2.680	149	9,5
54406 0008	544 1603R G2 RFLO	35	5.180	148	9,6
54406 0009	544 2403R G2 RFLO	53	7.750	146	9,7

colour temperature 3.000K (light colour 730)

54406 0010	544 0803R G2 730 RFLO	18	2.550	142	9,5
54406 0011	544 1603R G2 730 RFLO	35	4.920	141	9,6
54406 0012	544 2403R G2 730 RFLO	53	7.360	139	9,7

System accessories

Article No.	Type	
90546 9000	RFL DS20	RFL control element with light sensor, standalone, 20 lx
90543 0001	LASC DONGLE USB + SOFT + LIZ	LIMAS Air SYNC USB dongle with software and licence
90546 9014	RFL LASC DS	RFL LIMAS Air SYNC light management controller (2.4 GHz mesh network) with light sensor
90546 9010	RFL LASC DS GPS SIM	RFL LIMAS Air SYNC light management controller (2.4 GHz mesh network) with light sensor, GPS antenna and eSIM

Other sensors, e.g. environmental sensors (fine dust, CO₂, weather station etc.) on request.

Accessories / Spare Parts

Article No.	Type	
54410 0001	ABD 544 G2 ESGW	cover, pane safety glass clear, for 544...



CUPINA LED Pole-Top Light Fitting Series 556... G2

Applications:

556... G2:

Residential areas, residential and side streets, low traffic areas, footpaths and cycle tracks etc.

556... R G2:

Promenades, public parks, pedestrian areas etc.

Design :

Roof and supporting section: Aluminium, powder-coated DB 702 .

Cover: PMMA, clear, cylindrical.

Electrical components: Wired ready for

installation, disconnect plug-in connector to the mains connection terminal, cable retainer for connection cable, with LED module and ECG unit.

Light distribution: Asymmetrical wide beam or symmetrical circular beam (R).

Mounting system: 3 non-corrosive steel locking screws serve for fixation on straight poles Ø 76 mm. Adapter (RZ 1) for pole end Ø 60 mm (see accessories / spare parts).

Electrical design:

LED module: 4,000 K or 3,000 K, $R_a > 70$, service life $L_{95} > 100,000$ h, Zhaga compliant

ECG: 220-240 V, 50-60 Hz, Surge voltage resistance 10 kV, overload and short circuit protection.

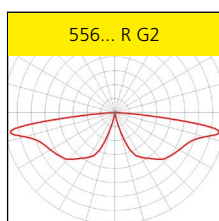
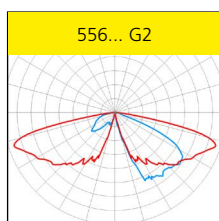
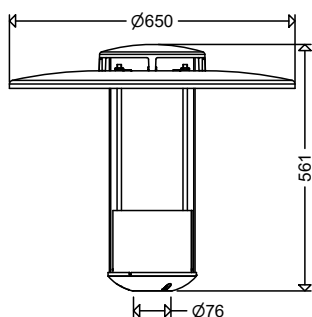

Options:

- 2,200 K; light colour (722)
- 1,800 K; light colour (518)
- asymmetrical extremely wide beam (RWX), for illuminating cycle paths
- special painting in RAL colours
- protection class I (SKI)
- seawater-resistant version
- for connection to a central power supply system (ZB)
- variable adjustable luminous flux via APP (NFC)
- Ready for Lightmanagement System (RFL), only possible without ring mirror accessories
- dimming function via DALI-2 interface, compatible with LIMAS Line wired Light Management System (DIMD)
- power reduction with control phase (LR)
- power reduction without control phase (LA)
- constant luminous flux function (CL)
- with backside light shielding (HA)
- Inclination adjustment of the LED unit, for illuminating wide roads

Product highlights:

- long-lasting, corrosion-resistant aluminium construction
- quick installation thanks to tool-free opening of the luminaire
- tool-free replacement of ECG and LED module
- homogeneous illumination due to the Multi-Layer-Technology
- BlackEdition, ULOR=0 % (Modifications with accessories influence the light distribution)
- eco-friendly, versions dimmable to 10% with luminous fluxes up to 2,000 lm and with color temperature up to 3,000 K comply with Dark Sky requirements
- sustainable, control gear and LED-module replaceable by qualified personnel on-site
- future proof by using standardised LED-modules (Zhaga) and long-term availability of spare parts



All CUPINA luminaires are also available in an RFL version and are therefore, thanks to their Zhaga Book 18-compliant base with D4i control gear, prepared for the subsequent use of a Light Management System.

! Properties, limitations and details for controlling LED-light fittings:

■ See "Technical Supplement"

All data are correct at the time of printing. Actual technical data can be found under www.schuch.de.

All light fittings also available with connected cable (see accessories in the data sheet).

Article No.	Type	Connected load [W]	Luminous flux [lm]	Luminous efficacy [lm/W]	Weight [kg] (without packing material)
-------------	------	--------------------	--------------------	--------------------------	--

556... G2



Wind load area
A = 0,13m²

asymmetrical wide beam

colour temperature 4.000K (light colour 740)

55600 0001	556 0801 G2	9	1.430	159	6,7
55600 0002	556 0802 G2	13	2.000	154	6,7
55600 0003	556 0803 G2	18	2.690	149	6,7
55600 0004	556 1601 G2	17	2.850	168	6,8
55600 0005	556 1602 G2	25	3.950	158	6,8
55600 0006	556 1603 G2	35	5.280	151	6,8

colour temperature 3.000K (light colour 730)

55600 0013	556 0801 G2 730	9	1.360	151	6,7
55600 0014	556 0802 G2 730	13	1.900	146	6,7
55600 0015	556 0803 G2 730	18	2.560	142	6,7
55600 0016	556 1601 G2 730	17	2.710	159	6,8
55600 0017	556 1602 G2 730	25	3.750	150	6,8
55600 0018	556 1603 G2 730	35	5.020	143	6,8

symmetrical circular beam

colour temperature 4.000K (light colour 740)

55600 0007	556 0801R G2	9	1.430	159	6,7
55600 0008	556 0802R G2	13	2.000	154	6,7
55600 0009	556 0803R G2	18	2.690	149	6,7
55600 0010	556 1601R G2	17	2.850	168	6,8
55600 0011	556 1602R G2	25	3.950	158	6,8
55600 0012	556 1603R G2	35	5.280	151	6,8

colour temperature 3.000K (light colour 730)

55600 0019	556 0801R G2 730	9	1.360	151	6,7
55600 0020	556 0802R G2 730	13	1.900	146	6,7
55600 0021	556 0803R G2 730	18	2.560	142	6,7
55600 0022	556 1601R G2 730	17	2.710	159	6,8
55600 0023	556 1602R G2 730	25	3.750	150	6,8
55600 0024	556 1603R G2 730	35	5.020	143	6,8



Outdoor
Light Fittings

All light fittings also available with connected cable (see accessories in the data sheet).



All luminaires also available with luminous flux adjustment via app (NFC version).

Article No.	Type	Connected load [W]	Luminous flux [lm] ¹⁾	Luminous efficacy [lm/W] (up to)	Substitute for ca. *	Weight [kg] (without packing material)
-------------	------	--------------------	----------------------------------	-------------------------------------	----------------------	---

556... G2 VARIO

IP54



Wind load area
A = 0,13m²

Design:

Same as type 556... G2 but: With switch for for variable adjustment of the luminous flux in the luminaire.

Product highlights of the VARIO version:

- simple, fast, tool-free setting of the luminous flux on site, by means of integrated switch, can be changed at any time
- reduction in the variety of types



asymmetrical wide beam

colour temperature 3.000K (light colour 730)

55601 0002	556 L25 G2 VARIO	5 - 18	660 - 2.690	144	HST 35 - HST 50	6,7
55601 0003	556 L50 G2 VARIO	9 - 35	1.320 - 5.280	156	HST 35 - 2 x HST 70	6,8

colour temperature 3.000K (light colour 730)

55601 0004	556 L25 G2 VARIO 730	5 - 18	630 - 2.560	136	HST 35 - HST 50	6,7
55601 0005	556 L50 G2 VARIO 730	9 - 35	1.250 - 5.020	147	HST 35 - 2 x HST 70	6,8

symmetrical circular beam

colour temperature 4.000K (light colour 740)

55601 0006	556 L25R G2 VARIO	5 - 18	660 - 2.690	144	HST 35 - HST 50	6,7
55601 0007	556 L50R G2 VARIO	9 - 35	1.320 - 5.280	156	HST 35 - 2 x HST 70	6,8

colour temperature 3.000K (light colour 730)

55601 0008	556 L25R G2 VARIO 730	5 - 18	630 - 2.560	136	HST 35 - HST 50	6,7
55601 0009	556 L50R G2 VARIO 730	9 - 35	1.250 - 5.020	147	HST 35 - 2 x HST 70	6,8

Factory setting L25: 18 W; replaces approx. HME 80, HST 50

1) possible setting range

Factory setting L50: 18 W; replaces approx. HME 125, HST 70

* The given information is for rough orientation only. In each individual case a lighting calculation is necessary.



with ring mirror



with frosted board cover



with frosted board cover
and ring mirror

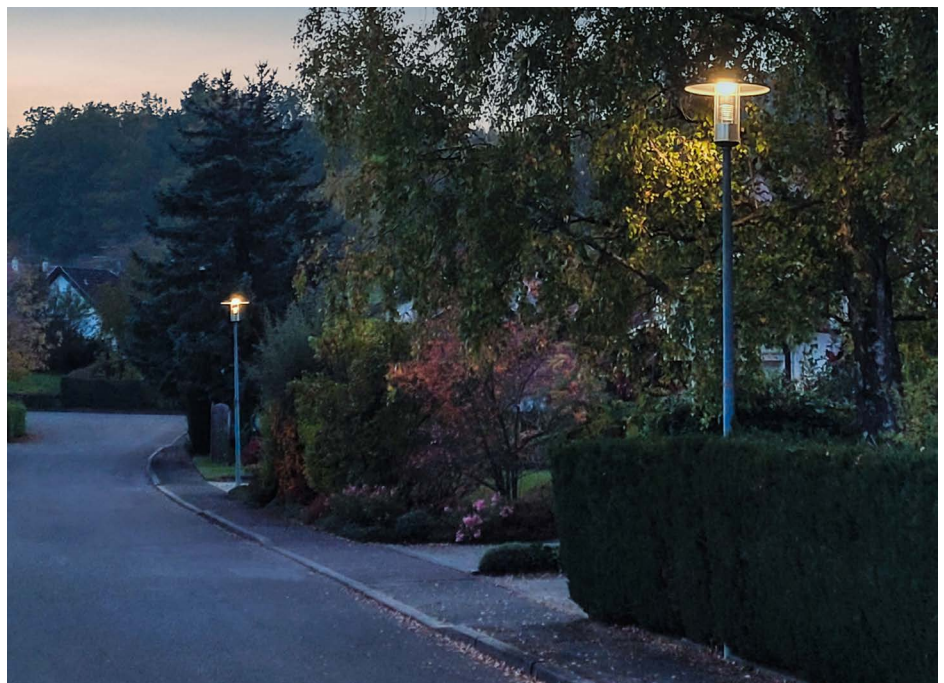

Accessories / Spare Parts

Article no.	Type	
10051 9000	ABD 541/55. PMMA	cover, cylinder PMMA clear, for 541, 553, 556, 557, 558...
10041 9001	ABDP 54./55. C PMMA	board cover, diffuser for glare limitation, diffuser PMMA satined, for 541, 543, 553, 556, 557, 558...
90116 9004	RS 54./55. G2	ring mirror, aluminium for series 541, 543, 553, 556, 557, 558... (Design element)
90126 0001	RZ 1 BK	adapter for mast top Ø 60 mm



PLANEO LED Pole-Top Light Fitting Series 557... G2

Applications:

557... G2:
Residential areas, residential and side streets, low traffic areas, footpaths and cycle tracks etc.

557... R G2:
Promenades, public parks, pedestrian areas etc.

Design :

Roof and supporting section: Aluminium, powder-coated DB 702.

Cover: PMMA, clear, cylindrical

Electrical components: Wired ready for

installation, disconnect plug-in connector to the mains connection terminal, cable retainer for connection cable, with LED module and ECG unit.

Light distribution: Asymmetrical wide beam or symmetrical circular beam (R).

Mounting system: 3 non-corrosive steel locking screws serve for fixation on straight poles Ø 76 mm. Adapter (RZ 1) for pole end Ø 60 mm (see accessories / spare parts).

Electrical design:

LED module: 4,000 K or 3,000 K, $R_a > 70$, service life $L_{95} > 100,000$ h, Zhaga compliant

ECG: 220-240 V, 50-60 Hz, Surge voltage resistance 10 kV, overload and short circuit protection.

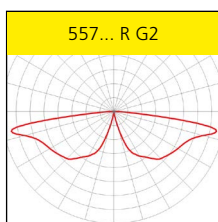
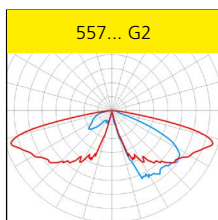
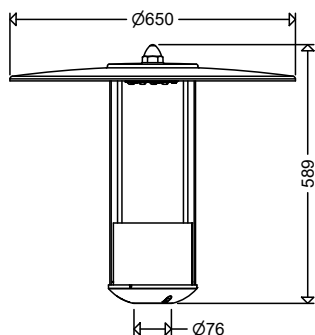

Options:

- 2,200 K; light colour (722)
- 1,800 K; light colour (518)
- asymmetrical extremely wide beam (RWX), for illuminating cycle paths
- special painting in RAL colours
- protection class I (SKI)
- seawater-resistant version
- for connection to a central power supply system (ZB)
- variable adjustable luminous flux via APP (NFC)
- Ready for Lightmanagement System (RFL), only possible without ring mirror accessories
- dimming function via DALI-2 interface, compatible with LIMAS Line wired Light Management System (DIMD)
- power reduction with control phase (LR)
- power reduction without control phase (LA)
- constant luminous flux function (CL)
- with backside light shielding (HA)
- Inclination adjustment of the LED unit, for illuminating wide roads

Product highlights:

- long-lasting, corrosion-resistant aluminium construction
- tool-free replacement of ECG and LED module
- homogeneous illumination due to the Multi-Layer-Technology
- BlackEdition, ULOR=0 % (Modifications with accessories influence the light distribution)
- eco-friendly, versions dimmable to 10% with luminous fluxes up to 2,000 lm and with color temperature up to 3,000 K comply with Dark Sky requirements
- sustainable, control gear and LED-module replaceable by qualified personnel on-site
- future proof by using standardised LED-modules (Zhaga) and long-term availability of spare parts



All PLANEO luminaires are also available in an RFL version and are therefore, thanks to their Zhaga Book 18-compliant base with D4i control gear, prepared for the subsequent use of a Light Management System.



! Properties, limitations and details for controlling LED-light fittings:

■ See "Technical Supplement"

All data are correct at the time of printing. Actual technical data can be found under www.schuch.de.

All light fittings also available with connected cable (see accessories in the data sheet).

Article No.	Type	Connected load [W]	Luminous flux [lm]	Luminous efficacy [lm/W]	Weight [kg] (without packing material)
-------------	------	--------------------	--------------------	--------------------------	--

557... G2



asymmetrical wide beam

colour temperature 4.000K (light colour 740)

55701 0001	557 0801 G2	9	1.430	159	5,9
55701 0002	557 0802 G2	13	2.000	154	5,9
55701 0003	557 0803 G2	18	2.690	149	5,9
55701 0004	557 1601 G2	17	2.850	168	6,0
55701 0005	557 1602 G2	25	3.950	158	6,0
55701 0006	557 1603 G2	35	5.280	151	6,0

colour temperature 3.000K (light colour 730)

55701 0013	557 0801 G2 730	9	1.360	151	5,9
55701 0014	557 0802 G2 730	13	1.900	146	5,9
55701 0015	557 0803 G2 730	18	2.560	142	5,9
55701 0016	557 1601 G2 730	17	2.710	159	6,0
55701 0017	557 1602 G2 730	25	3.750	150	6,0
55701 0018	557 1603 G2 730	35	5.020	143	6,0

symmetrical circular beam

colour temperature 4.000K (light colour 740)

55701 0007	557 0801R G2	9	1.430	159	5,9
55701 0008	557 0802R G2	13	2.000	154	5,9
55701 0009	557 0803R G2	18	2.690	149	5,9
55701 0010	557 1601R G2	17	2.850	168	6,0
55701 0011	557 1602R G2	25	3.950	158	6,0
55701 0012	557 1603R G2	35	5.280	151	6,0

colour temperature 3.000K (light colour 730)

55701 0019	557 0801R G2 730	9	1.360	151	5,9
55701 0020	557 0802R G2 730	13	1.900	146	5,9
55701 0021	557 0803R G2 730	18	2.560	142	5,9
55701 0022	557 1601R G2 730	17	2.710	159	6,0
55701 0023	557 1602R G2 730	25	3.750	150	6,0
55701 0024	557 1603R G2 730	35	5.020	143	6,0

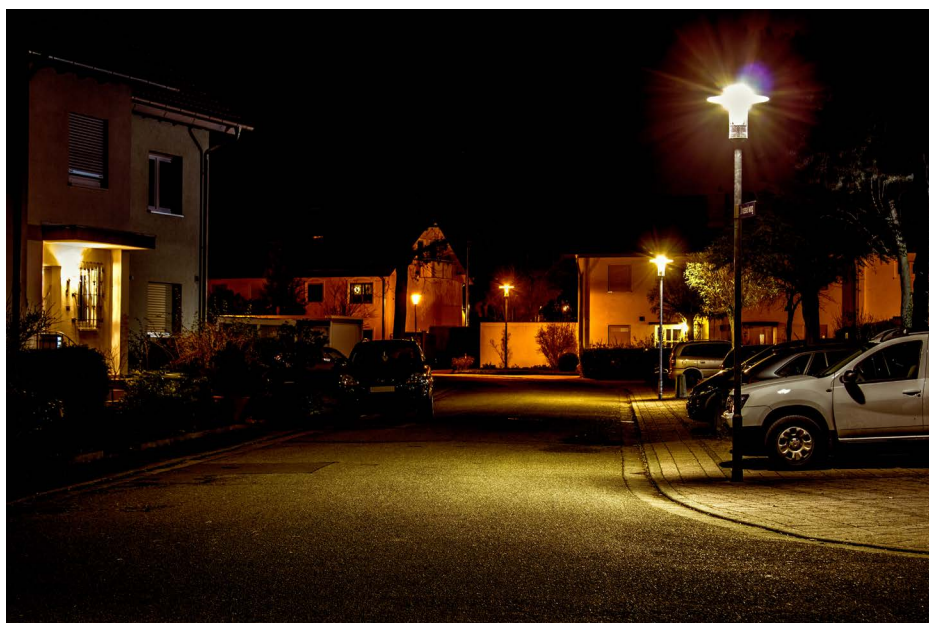

All light fittings also available with connected cable (see accessories in the data sheet).



All luminaires also available with luminous flux adjustment via app (NFC version).

Article No.	Type	Connected load [W]	Luminous flux [lm] ¹⁾	Luminous efficacy [lm/W] (up to)	Substitute for ca. *	Weight [kg] (without packing material)
-------------	------	--------------------	----------------------------------	----------------------------------	----------------------	--

557... G2 VARIO



Design:

Same as type 557... G2 but: With switch for for variable adjustment of the luminous flux in the luminaire.

Product highlights of the VARIO version:

- simple, fast, tool-free setting of the luminous flux on site, by means of integrated switch, can be changed at any time
- reduction in the variety of types



asymmetrical wide beam

colour temperature 3.000K (light colour 730)

55702 0002	557 L25 G2 VARIO	5 - 18	660 - 2.690	144	HST 35 - HST 50	5,9
55702 0001	557 L50 G2 VARIO	9 - 35	1.320 - 5.280	156	HST 35 - 2 x HST 70	6,0

colour temperature 3.000K (light colour 730)

55702 0003	557 L25 G2 VARIO 730	5 - 18	630 - 2.560	136	HST 35 - HST 50	5,9
55702 0004	557 L50 G2 VARIO 730	9 - 35	1.250 - 5.020	147	HST 35 - 2 x HST 70	6,0

symmetrical circular beam

colour temperature 4.000K (light colour 740)

55702 0005	557 L25R G2 VARIO	5 - 18	660 - 2.690	144	HST 35 - HST 50	5,9
55702 0006	557 L50R G2 VARIO	9 - 35	1.320 - 5.280	156	HST 35 - 2 x HST 70	6,0

colour temperature 3.000K (light colour 730)

55702 0007	557 L25R G2 VARIO 730	5 - 18	630 - 2.560	136	HST 35 - HST 50	5,9
55702 0008	557 L50R G2 VARIO 730	9 - 35	1.250 - 5.020	147	HST 35 - 2 x HST 70	6,0

Factory setting L25: 18 W; replaces approx. HME 80, HST 50

Factory setting L50: 18 W; replaces approx. HME 125, HST 70

1) possible setting range

* The given information is for rough orientation only. In each individual case a lighting calculation is necessary.



with ring mirror



with frosted board cover



with frosted board cover and ring mirror

Accessories / Spare Parts

Article no.	Type	
10051 9000	ABD 541/55. PMMA	cover, cylinder PMMA clear, for 541, 553, 556, 557, 558...
10041 9001	ABDP 54./55. C PMMA	board cover, diffuser for glare limitation, diffuser PMMA satined, for 541, 543, 553, 556, 557, 558...
90116 9004	RS 54./55. G2	ring mirror, aluminium for series 541, 543, 553, 556, 557, 558... (Design element)
90126 0001	RZ 1 BK	adapter for mast top Ø 60 mm



CILA LED Pole-Top Light Fitting Series 558... G2

Applications:

558... G2:
Residential areas, residential and side streets, low traffic areas, footpaths and cycle tracks etc.

558... R G2:
Promenades, public parks, pedestrian areas etc.

Design :

Roof and supporting section: Aluminium, powder-coated DB 702.

Cover: PMMA, clear, cylindrical

Electrical components: Wired ready for installation, disconnect plug-in connector to the mains connection terminal, cable retainer for connection cable, with LED module and ECG unit.

Light distribution: Asymmetrical wide beam or symmetrical circular beam (R).

Mounting system: 3 non-corrosive steel locking screws serve for fixation on straight poles Ø 76 mm. Adapter (RZ 1) for pole end Ø 60 mm (see accessories / spare parts).

Electrical design:

LED module: 4,000 K or 3,000 K, $R_a > 70$, service life $L_{95} > 100,000$ h, Zhaga compliant

ECG: 220-240 V, 50-60 Hz, Surge voltage resistance 10 kV, overload and short circuit protection.

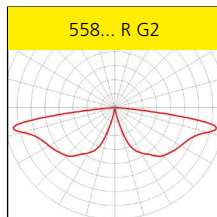
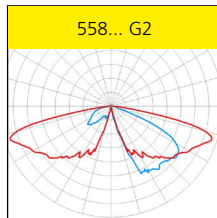
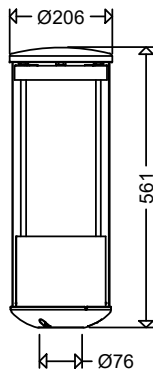

Options:

- 2,200 K; light colour (722)
- 1,800 K; light colour (518)
- asymmetrical extremely wide beam (RWX), for illuminating cycle paths
- special painting in RAL colours
- protection class I (SKI)
- seawater-resistant version
- for connection to a central power supply system (ZB)
- variable adjustable luminous flux via APP (NFC)
- Ready for Lightmanagement System (RFL), only possible without ring mirror accessories
- dimming function via DALI-2 interface, compatible with LIMAS Line wired Light Management System (DIMD)
- power reduction with control phase (LR)
- power reduction without control phase (LA)
- constant luminous flux function (CL)
- with backside light shielding (HA)
- Inclination adjustment of the LED unit, for illuminating wide roads

Product highlights:

- long-lasting, corrosion-resistant aluminium construction
- quick installation thanks to tool-free opening of the luminaire
- tool-free replacement of ECG and LED module
- homogeneous illumination due to the Multi-Layer-Technology
- BlackEdition, ULOR=0 % (Modifications with accessories influence the light distribution)
- eco-friendly, versions dimmable to 10% with luminous fluxes up to 2,000 lm and with color temperature up to 3,000 K comply with Dark Sky requirements
- sustainable, control gear and LED-module replaceable by qualified personnel on-site
- future proof by using standardised LED-modules (Zhaga) and long-term availability of spare parts



All CILA luminaires are also available in an RFL version and are therefore, thanks to their Zhaga Book 18-compliant base with D4i control gear, prepared for the subsequent use of a Light Management System.



! Properties, limitations and details for controlling LED-light fittings:

■ See "Technical Supplement"

All data are correct at the time of printing. Actual technical data can be found under www.schuch.de.

All light fittings also available with connected cable (see accessories in the data sheet).

Article No.	Type	Connected load [W]	Luminous flux [lm]	Luminous efficacy [lm/W]	Weight [kg] (without packing material)
-------------	------	--------------------	--------------------	--------------------------	--

558... G2

IP54



Wind load area
A = 0,11m²

asymmetrical wide beam

colour temperature 4.000K (light colour 740)

55801 0001	558 0801 G2	9	1.430	159	4,7
55801 0002	558 0802 G2	13	2.000	154	4,7
55801 0003	558 0803 G2	18	2.690	149	4,7
55801 0004	558 1601 G2	17	2.850	168	4,8
55801 0005	558 1602 G2	25	3.950	158	4,8
55801 0006	558 1603 G2	35	5.280	151	4,8

colour temperature 3.000K (light colour 730)

55801 0013	558 0801 G2 730	9	1.360	151	4,7
55801 0014	558 0802 G2 730	13	1.900	146	4,7
55801 0015	558 0803 G2 730	18	2.560	142	4,7
55801 0016	558 1601 G2 730	17	2.710	159	4,8
55801 0017	558 1602 G2 730	25	3.750	150	4,8
55801 0018	558 1603 G2 730	35	5.020	143	4,8

symmetrical circular beam

colour temperature 4.000K (light colour 740)

55801 0007	558 0801R G2	9	1.430	159	4,7
55801 0008	558 0802R G2	13	2.000	154	4,7
55801 0009	558 0803R G2	18	2.690	149	4,7
55801 0010	558 1601R G2	17	2.850	168	4,8
55801 0011	558 1602R G2	25	3.950	158	4,8
55801 0012	558 1603R G2	35	5.280	151	4,8

colour temperature 3.000K (light colour 730)

55801 0019	558 0801R G2 730	9	1.360	151	4,7
55801 0020	558 0802R G2 730	13	1.900	146	4,7
55801 0021	558 0803R G2 730	18	2.560	142	4,7
55801 0022	558 1601R G2 730	17	2.710	159	4,8
55801 0023	558 1602R G2 730	25	3.750	150	4,8
55801 0024	558 1603R G2 730	35	5.020	143	4,8



Outdoor
Light Fittings

All light fittings also available with connected cable (see accessories in the data sheet).



All luminaires also available with luminous flux adjustment via app (NFC version).

Article No.	Type	Connected load [W]	Luminous flux [lm] ¹⁾	Luminous efficacy [lm/W] (up to)	Substitute for ca. *	Weight [kg] (without packing material)
-------------	------	--------------------	----------------------------------	----------------------------------	----------------------	--

558... G2 VARIO



Design:

Same as type 558... G2 but: With switch for for variable adjustment of the luminous flux in the luminaire.

Product highlights of the VARIO version:

- simple, fast, tool-free setting of the luminous flux on site, by means of integrated switch, can be changed at any time
- reduction in the variety of types



asymmetrical wide beam

colour temperature 3.000K (light colour 730)

55802 0002	558 L25 G2 VARIO	5 - 18	660 - 2.690	144	HST 35 - HST 50	4,7
55802 0003	558 L50 G2 VARIO	9 - 35	1.320 - 5.280	156	HST 35 - 2 x HST 70	4,8

colour temperature 3.000K (light colour 730)

55802 0004	558 L25 G2 VARIO 730	5 - 18	630 - 2.560	136	HST 35 - HST 50	4,7
55802 0005	558 L50 G2 VARIO 730	9 - 35	1.250 - 5.020	147	HST 35 - 2 x HST 70	4,8

symmetrical circular beam

colour temperature 4.000K (light colour 740)

55802 0006	558 L25R G2 VARIO	5 - 18	660 - 2.690	144	HST 35 - HST 50	4,7
55802 0007	558 L50R G2 VARIO	9 - 35	1.320 - 5.280	156	HST 35 - 2 x HST 70	4,8

colour temperature 3.000K (light colour 730)

55802 0008	558 L25R G2 VARIO 730	5 - 18	630 - 2.560	136	HST 35 - HST 50	4,7
55802 0009	558 L50R G2 VARIO 730	9 - 35	1.250 - 5.020	147	HST 35 - 2 x HST 70	4,8

Factory setting L25: 18 W; replaces approx. HME 80, HST 50

1) possible setting range

Factory setting L50: 18 W; replaces approx. HME 125, HST 70

* The given information is for rough orientation only. In each individual case a lighting calculation is necessary.



with ring mirror



with frosted board cover



with frosted board cover and ring mirror

Accessories / Spare Parts

Article no.	Type	
10051 9000	ABD 541/55. PMMA	cover, cylinder PMMA clear, for 541, 553, 556, 557, 558...
10041 9001	ABDP 54./55. C PMMA	board cover, diffuser for glare limitation, diffuser PMMA satined, for 541, 543, 553, 556, 557, 558...
90116 9004	RS 54./55. G2	ring mirror, aluminium for series 541, 543, 553, 556, 557, 558... (Design element)
90126 0001	RZ 1 BK	adapter for mast top Ø 60 mm

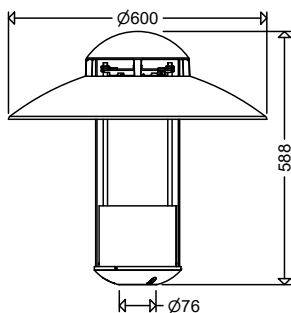

CAPA LED Pole-Top Light Fitting Series 541... G2

Applications:

541... G2:

Residential areas, residential and side streets, low traffic areas, footpaths and cycle tracks etc.

541... R G2:

Promenades, public parks, pedestrian areas etc.

Design:

Supporting section, roof and top cover: Aluminium, powder-coated DB 702.

Cover: PMMA, clear, cylindrical

Electrical components: Wired ready for

installation, disconnect plug-in connector to the mains connection terminal, cable retainer for connection cable, with LED module and ECG unit.

Light distribution: Asymmetrical wide beam or symmetrical circular beam (R).

Mounting system: 3 non-corrosive steel locking screws serve for fixation on straight pole end Ø 76 mm.

Adapter (RZ 1) for pole end Ø 60 mm (see accessories / spare parts).

Electrical design:

LED module: 4,000 K or 3,000 K, $R_a > 70$, service life $L_{95} > 100,000$ h, Zhaga compliant

ECG: 220-240 V, 50-60 Hz, Surge voltage resistance 10 kV, overload and short circuit protection.

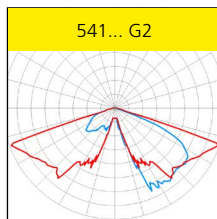

Options:

- 2,200 K; light colour (722)
- 1,800 K; light colour (518)
- asymmetrical extremely wide beam (RWX), for illuminating cycle paths
- special painting in RAL colours
- protection class I (SKI)
- seawater-resistant version

- dimming function via DALI-2 interface, compatible with LIMAS Line wired Light Management System (DIMD)
- power reduction with control phase (LR)

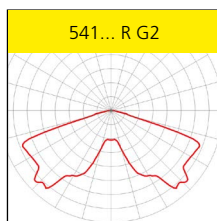

- for connection to a central power supply system (ZB)
- variable adjustable luminous flux via APP (NFC)
- Ready for Lightmanagement System (RFL), only possible without ring mirror accessories

- power reduction without control phase (LA)
- constant luminous flux function (CL)
- with backside light shielding (HA)
- Inclination adjustment of the LED unit, for illuminating wide roads



Product highlights:

- long-lasting, corrosion-resistant aluminium construction
- quick installation thanks to tool-free opening of the luminaire
- tool-free replacement of ECG and LED module
- homogeneous illumination due to the Multi-Layer-Technology
- BlackEdition, ULOR=0 % (Modifications with accessories influence the light distribution)
- eco-friendly, versions dimmable to 10% with luminous fluxes up to 2,000 lm and with color temperature up to 3,000 K comply with Dark Sky requirements
- sustainable, control gear and LED-module replaceable by qualified personnel on-site
- future proof by using standardised LED-modules (Zhaga) and long-term availability of spare parts



All CAPA luminaires are also available in an RFL version and are therefore, thanks to their Zhaga Book 18-compliant base with D4i control gear, prepared for the subsequent use of a Light Management System.



! Properties, limitations and details for controlling LED-light fittings:

■ See "Technical Supplement"

All data are correct at the time of printing. Actual technical data can be found under www.schuch.de.

All light fittings also available with connected cable (see accessories in the data sheet).

Article No.	Type	Connected load [W]	Luminous flux [lm]	Luminous efficacy [lm/W]	Weight [kg] (without packing material)
-------------	------	--------------------	--------------------	--------------------------	---

541... G2



Wind load area
A = 0,13m²

asymmetrical wide beam

colour temperature 4.000K (light colour 740)

54100 0001	541 0801 G2	9	1.380	153	7,1
54100 0002	541 0802 G2	13	1.920	148	7,1
54100 0003	541 0803 G2	18	2.590	144	7,1
54100 0004	541 1601 G2	17	2.740	161	7,2
54100 0005	541 1602 G2	25	3.800	152	7,2
54100 0006	541 1603 G2	35	5.080	145	7,2

colour temperature 3.000K (light colour 730)

54100 0013	541 0801 G2 730	9	1.310	146	7,1
54100 0014	541 0802 G2 730	13	1.820	140	7,1
54100 0015	541 0803 G2 730	18	2.460	137	7,1
54100 0016	541 1601 G2 730	17	2.600	153	7,2
54100 0017	541 1602 G2 730	25	3.610	144	7,2
54100 0018	541 1603 G2 730	35	4.830	138	7,2

symmetrical circular beam

colour temperature 4.000K (light colour 740)

54100 0007	541 0801R G2	9	1.380	153	7,1
54100 0008	541 0802R G2	13	1.920	148	7,1
54100 0009	541 0803R G2	18	2.590	144	7,1
54100 0010	541 1601R G2	17	2.740	161	7,2
54100 0011	541 1602R G2	25	3.800	152	7,2
54100 0012	541 1603R G2	35	5.080	145	7,2

colour temperature 3.000K (light colour 730)

54100 0013	541 0801R G2 730	9	1.310	146	7,1
54100 0014	541 0802R G2 730	13	1.820	140	7,1
54100 0015	541 0803R G2 730	18	2.460	137	7,1
54100 0016	541 1601R G2 730	17	2.600	153	7,2
54100 0017	541 1602R G2 730	25	3.610	144	7,2
54100 0018	541 1603R G2 730	35	4.830	138	7,2



All light fittings also available with connected cable (see accessories in the data sheet).



All luminaires also available with luminous flux adjustment via app (NFC version).

Article No.	Type	Connected load [W]	Luminous flux [lm] ¹⁾	Luminous efficacy [lm/W] (up to)	Substitute for ca. *	Weight [kg] (without packing material)
-------------	------	--------------------	----------------------------------	----------------------------------	----------------------	--

541... G2 VARIO



Design:

Same as type 541... G2 but: With switch for for variable adjustment of the luminous flux in the luminaire.

Product highlights of the VARIO version:

- simple, fast, tool-free setting of the luminous flux on site, by means of integrated switch, can be changed at any time
- reduction in the variety of types



asymmetrical wide beam

colour temperature 3.000K (light colour 730)

54101 0001	541 L25 G2 VARIO	5 - 18	630 - 2.590	153	HST 35 - HST 50	7,1
54101 0002	541 L50 G2 VARIO	9 - 35	1.270 - 5.080	162	HST 35 - 2 x HST 70	7,2

colour temperature 3.000K (light colour 730)

54101 0003	541 L25 G2 VARIO 730	5 - 18	600 - 2.460	146	HST 35 - HST 50	7,1
54101 0004	541 L50 G2 VARIO 730	9 - 35	1.210 - 4.830	154	HST 35 - 2 x HST 70	7,2

symmetrical circular beam

colour temperature 4.000K (light colour 740)

54101 0005	541 L25R G2 VARIO	5 - 18	630 - 2.590	153	HST 35 - HST 50	7,1
54101 0006	541 L50R G2 VARIO	9 - 35	1.270 - 5.080	162	HST 35 - 2 x HST 70	7,2

colour temperature 3.000K (light colour 730)

54101 0007	541 L25R G2 VARIO 730	5 - 18	600 - 2.460	146	HST 35 - HST 50	7,1
54101 0008	541 L50R G2 VARIO 730	9 - 35	1.210 - 4.830	154	HST 35 - 2 x HST 70	7,2

Factory setting L25: 18 W; replaces approx. HME 80, HST 50

1) possible setting range

Factory setting L50: 18 W; replaces approx. HME 125, HST 70

* The given information is for rough orientation only. In each individual case a lighting calculation is necessary.



with ring mirror



with frosted board cover



with frosted board cover and ring mirror

Accessories / Spare Parts

Article no.	Type	
10051 9000	ABD 541/55. PMMA	cover, cylinder PMMA clear, for 541, 553, 556, 557, 558...
10041 9001	ABDP 54./55. C PMMA	board cover, diffuser for glare limitation, diffuser PMMA satined, for 541, 543, 553, 556, 557, 558...
90116 9004	RS 54./55. G2	ring mirror, aluminium for series 541, 543, 553, 556, 557, 558... (Design element)
90126 0001	RZ 1 BK	adapter for mast top Ø 60 mm

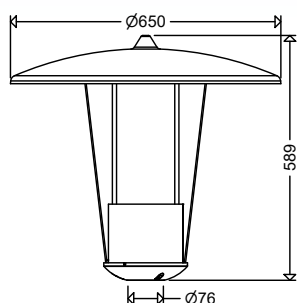

RETRO LED Pole-Top Light Fitting Series 543... G2

Applications:

Residential areas, residential and side streets, low traffic areas, footpaths and cycle tracks etc.

Design:

Roof: Glass fibre reinforced polyester resin with integrated insert nut (colour: similar to RAL 7035).

Supporting section: Aluminium powder coated light grey (RAL 7035).

Cover: PMMA, clear, conical

Electrical components: Wired ready for

installation, disconnect plug-in connector to the mains connection terminal, cable retainer for connection cable, with LED module and ECG unit.

Light distribution: Asymmetrical wide beam or symmetrical circular beam (R).

Mounting system: 3 non-corrosive steel locking screws serve for fixation on straight poles Ø 76 mm. Adapter (RZ 1) for pole end Ø 60 mm (see accessories / spare parts).

Electrical design:

LED module: 4,000 K or 3,000 K, $R_a > 70$, service life $L_{95} > 100,000$ h, Zhaga compliant

ECG: 220-240 V, 50-60 Hz, Surge voltage resistance 10 kV, overload and short circuit protection.

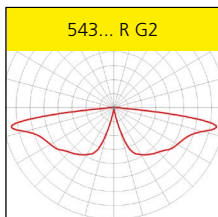
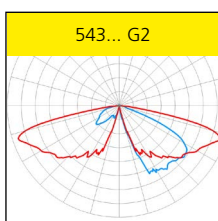

Options:

- 2,200 K; light colour (722)
- 1,800 K; light colour (518)
- asymmetrical extremely wide beam (RWX), for illuminating cycle paths
- special painting in RAL colours
- protection class I (SKI)
- seawater-resistant version
- for connection to a central power supply system (ZB)
- variable adjustable luminous flux via APP (NFC)
- Ready for Lightmanagement System (RFL), only possible without ring mirror accessories
- dimming function via DALI-2 interface, compatible with LIMAS Line wired Light Management System (DIMD)
- power reduction with control phase (LR)
- power reduction without control phase (LA)
- constant luminous flux function (CL)
- with backside light shielding (HA)
- Inclination adjustment of the LED unit, for illuminating wide roads



Product highlights:

- quick installation thanks to tool-free opening of the luminaire
- tool-free replacement of ECG and LED module
- homogeneous illumination due to the Multi-Layer-Technology
- BlackEdition, ULOR=0 % (Modifications with accessories influence the light distribution)
- eco-friendly, versions dimmable to 10% with luminous fluxes up to 2,000 lm and with color temperature up to 3,000 K comply with Dark Sky requirements
- sustainable, control gear and LED-module replaceable by qualified personnel on-site
- future proof by using standardised LED-modules (Zhaga) and long-term availability of spare parts



All RETRO luminaires are also available in an RFL version and are therefore, thanks to their Zhaga Book 18-compliant base with D4i control gear, prepared for the subsequent use of a Light Management System.



! Properties, limitations and details for controlling LED-light fittings:

■ See "Technical Supplement"

All data are correct at the time of printing. Actual technical data can be found under www.schuch.de.

All light fittings also available with connected cable (see accessories in the data sheet).

Article No.	Type	Connected load [W]	Luminous flux [lm]	Luminous efficacy [lm/W]	Weight [kg] (without packing material)
-------------	------	--------------------	--------------------	--------------------------	---

543... G2

IP54



Wind load area
A = 0,15m²

asymmetrical wide beam

colour temperature 4.000K (light colour 740)

54300 0001	543 0801 G2	9	1.430	159	7,0
54300 0002	543 0802 G2	13	2.000	154	7,0
54300 0003	543 0803 G2	18	2.690	149	7,0
54300 0004	543 1601 G2	17	2.850	168	7,1
54300 0005	543 1602 G2	25	3.950	158	7,1
54300 0006	543 1603 G2	35	5.280	151	7,1

colour temperature 3.000K (light colour 730)

54300 0013	543 0801 G2 730	9	1.360	151	7,0
54300 0014	543 0802 G2 730	13	1.900	146	7,0
54300 0015	543 0803 G2 730	18	2.560	142	7,0
54300 0016	543 1601 G2 730	17	2.710	159	7,1
54300 0017	543 1602 G2 730	25	3.750	150	7,1
54300 0018	543 1603 G2 730	35	5.020	143	7,1

symmetrical circular beam

colour temperature 4.000K (light colour 740)

54300 0007	543 0801R G2	9	1.430	159	7,0
54300 0008	543 0802R G2	13	2.000	154	7,0
54300 0009	543 0803R G2	18	2.690	149	7,0
54300 0010	543 1601R G2	17	2.850	168	7,1
54300 0011	543 1602R G2	25	3.950	158	7,1
54300 0012	543 1603R G2	35	5.280	151	7,1

colour temperature 3.000K (light colour 730)

54300 0019	543 0801R G2 730	9	1.360	151	7,0
54300 0020	543 0802R G2 730	13	1.900	146	7,0
54300 0021	543 0803R G2 730	18	2.560	142	7,0
54300 0022	543 1601R G2 730	17	2.710	159	7,1
54300 0023	543 1602R G2 730	25	3.750	150	7,1
54300 0024	543 1603R G2 730	35	5.020	143	7,1

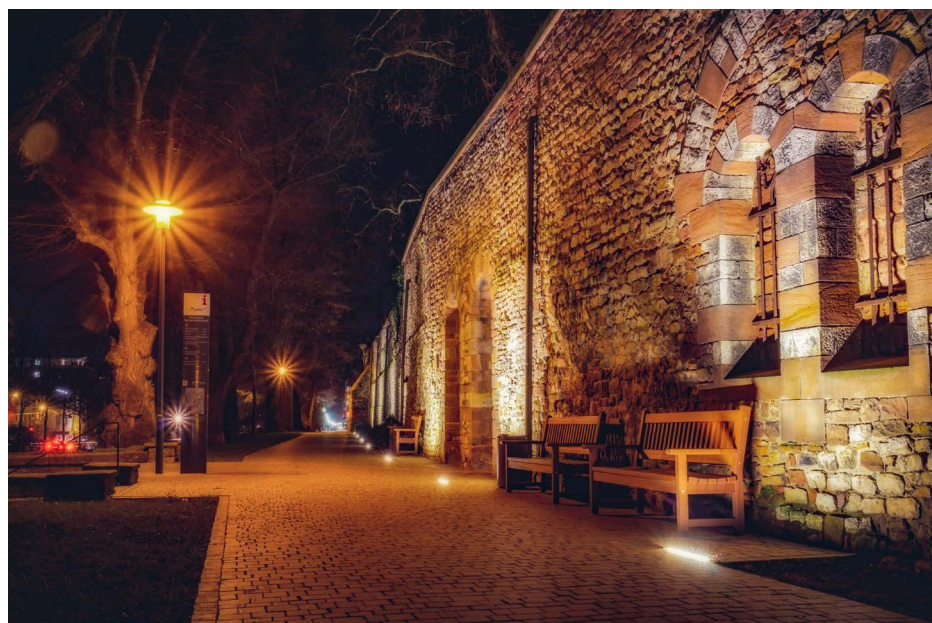

Outdoor
Light Fittings

All light fittings also available with connected cable (see accessories in the data sheet).



All luminaires also available with luminous flux adjustment via app (NFC version).

Article No.	Type	Connected load [W]	Luminous flux [lm] ¹⁾	Luminous efficacy [lm/W] (up to)	Substitute for ca. *	Weight [kg] (without packing material)
-------------	------	--------------------	----------------------------------	----------------------------------	----------------------	--

543... G2 VARIO

IP54



Wind load area
A = 0,15m²

Design:

Same as type 543... G2 but: With switch for for variable adjustment of the luminous flux in the luminaire.

Product highlights of the VARIO version:

- simple, fast, tool-free setting of the luminous flux on site, by means of integrated switch, can be changed at any time
- reduction in the variety of types



asymmetrical wide beam

colour temperature 3.000K (light colour 730)

54301 0004	543 L25 G2 VARIO	5 - 18	660 - 2.690	144	HST 35 - HST 50	7,0
54301 0005	543 L50 G2 VARIO	9 - 35	1.320 - 5.280	156	HST 35 - 2 x HST 70	7,1

colour temperature 3.000K (light colour 730)

54301 0006	543 L25 G2 VARIO 730	5 - 18	630 - 2.560	136	HST 35 - HST 50	7,0
54301 0003	543 L50 G2 VARIO 730	9 - 35	1.250 - 5.020	147	HST 35 - 2 x HST 70	7,1

symmetrical circular beam

colour temperature 4.000K (light colour 740)

54301 0007	543 L25R G2 VARIO	5 - 18	660 - 2.690	144	HST 35 - HST 50	7,0
54301 0008	543 L50R G2 VARIO	9 - 35	1.320 - 5.280	156	HST 35 - 2 x HST 70	7,1

colour temperature 3.000K (light colour 730)

54301 0009	543 L25R G2 VARIO 730	5 - 18	630 - 2.560	136	HST 35 - HST 50	7,0
54301 0001	543 L50R G2 VARIO 730	9 - 35	1.250 - 5.020	147	HST 35 - 2 x HST 70	7,1

Factory setting L25: 18 W; replaces approx. HME 80, HST 50

1) possible setting range

Factory setting L50: 18 W; replaces approx. HME 125, HST 70

* The given information is for rough orientation only. In each individual case a lighting calculation is necessary.



with ring mirror



with frosted board cover



with frosted board cover and ring mirror

Accessories / Spare Parts

Article no.	Type	
10043 9000	ABD 543 PMMA	cover, conus PMMA clear, for 543...
10041 9001	ABDP 54./55. C PMMA	board cover, diffuser for glare limitation, diffuser PMMA satined, for 541, 543, 553, 556, 557, 558...
90128 9001	DACH 542/43 POL M10	spare roof, polyester, for light fittings with integrated cover nut
90127 9000	DACH 542/43 AL RAL7035	spare roof, aluminium, for light fittings with separate cover nut
90116 9004	RS 54./55. G2	ring mirror, aluminium for series 541, 543, 553, 556, 557, 558... (Design element)
90044 0001	RZ 1 GY	adapter for mast top Ø 60 mm

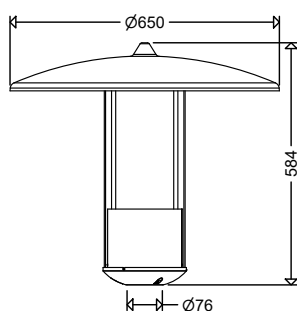

RETRO Z LED Pole-Top Light Fitting Series 553... G2

Applications:

553...:

Residential areas, residential and side streets, low traffic areas, footpaths and cycle tracks etc.

553... R:

Promenades, public parks, pedestrian areas etc.

Design :

Roof: Glass fibre reinforced polyester resin with integrated insert nut (colour: similar to RAL 7035).

Supporting section: Aluminium powder coated light grey (RAL 7035).

Cover: PMMA, clear, cylindrical.

Electrical components: Wired ready for installation, disconnect plug-in connector to the mains connection terminal, cable retainer for connection cable, with LED module and ECG unit.

Light distribution: Asymmetrical wide beam or symmetrical circular beam (R).

Mounting system: 3 non-corrosive steel locking screws serve for fixation on straight poles Ø 76 mm. Adapter (RZ 1) for pole end Ø 60 mm (see accessories / spare parts).

Electrical design:

LED module: 4,000 K or 3,000 K, $R_a > 70$, service life $L_{95} > 100,000$ h, Zhaga compliant

ECG: 220-240 V, 50-60 Hz, Surge voltage resistance 10 kV, overload and short circuit protection.

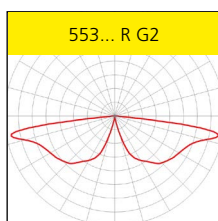
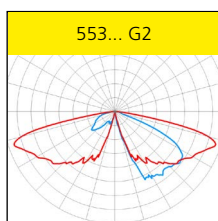

Options:

- 2,200 K; light colour (722)
- 1,800 K; light colour (518)
- asymmetrical extremely wide beam (RWX), for illuminating cycle paths
- special painting in RAL colours
- protection class I (SKI)
- seawater-resistant version
- for connection to a central power supply system (ZB)
- variable adjustable luminous flux via APP (NFC)
- Ready for Lightmanagement System (RFL), only possible without ring mirror accessories
- dimming function via DALI-2 interface, compatible with LIMAS Line wired Light Management System (DIMD)
- power reduction with control phase (LR)
- power reduction without control phase (LA)
- constant luminous flux function (CL)
- with backside light shielding (HA)
- Inclination adjustment of the LED unit, for illuminating wide roads

Product highlights:

- quick installation thanks to **tool-free opening** of the luminaire
- **tool-free replacement** of ECG and LED module
- **homogeneous illumination** due to the **Multi-Layer-Technology**
- **BlackEdition**, $ULOR=0$ % (Modifications with accessories influence the light distribution)
- **eco-friendly**, versions dimmable to 10% with luminous fluxes up to 2,000 lm and with color temperature up to 3,000 K comply with **Dark Sky requirements**
- **sustainable**, control gear and LED-module replaceable by qualified personnel on-site
- **future proof** by using standardised LED-modules (Zhaga) and long-term availability of spare parts



All RETRO Z luminaires are also available in an RFL version and are therefore, thanks to their Zhaga Book 18-compliant base with D4i control gear, prepared for the subsequent use of a Light Management System.



Properties, limitations and details for controlling LED-light fittings:

See "Technical Supplement"

All data are correct at the time of printing. Actual technical data can be found under www.schuch.de.

All light fittings also available with connected cable (see accessories in the data sheet).

Article No.	Type	Connected load [W]	Luminous flux [lm]	Luminous efficacy [lm/W]	Weight [kg] (without packing material)
-------------	------	--------------------	--------------------	--------------------------	--

553... G2

IP54



Wind load area
A = 0,13m²

asymmetrical wide beam

colour temperature 4.000K (light colour 740)

55300 0001	553 0801 G2	9	1.430	159	7,0
55300 0002	553 0802 G2	13	2.000	154	7,0
55300 0003	553 0803 G2	18	2.690	149	7,0
55300 0004	553 1601 G2	17	2.850	168	7,1
55300 0005	553 1602 G2	25	3.950	158	7,1
55300 0006	553 1603 G2	35	5.280	151	7,1

colour temperature 3.000K (light colour 730)

55300 0013	553 0801 G2 730	9	1.360	151	7,0
55300 0014	553 0802 G2 730	13	1.900	146	7,0
55300 0015	553 0803 G2 730	18	2.560	142	7,0
55300 0016	553 1601 G2 730	17	2.710	159	7,1
55300 0017	553 1602 G2 730	25	3.750	150	7,1
55300 0018	553 1603 G2 730	35	5.020	143	7,1

symmetrical circular beam

colour temperature 4.000K (light colour 740)

55300 0007	553 0801R G2	9	1.430	159	7,0
55300 0008	553 0802R G2	13	2.000	154	7,0
55300 0009	553 0803R G2	18	2.690	149	7,0
55300 0010	553 1601R G2	17	2.850	168	7,1
55300 0011	553 1602R G2	25	3.950	158	7,1
55300 0012	553 1603R G2	35	5.280	151	7,1

colour temperature 3.000K (light colour 730)

55300 0019	553 0801R G2 730	9	1.360	151	7,0
55300 0020	553 0802R G2 730	13	1.900	146	7,0
55300 0021	553 0803R G2 730	18	2.560	142	7,0
55300 0022	553 1601R G2 730	17	2.710	159	7,1
55300 0023	553 1602R G2 730	25	3.750	150	7,1
55300 0024	553 1603R G2 730	35	5.020	143	7,1

All light fittings also available with connected cable (see accessories in the data sheet).



All luminaires also available with luminous flux adjustment via app (NFC version).

Article No.	Type	Connected load [W]	Luminous flux [lm] ¹⁾	Luminous efficacy [lm/W] (up to)	Substitute for ca. *	Weight [kg] (without packing material)
-------------	------	--------------------	----------------------------------	----------------------------------	----------------------	--

553... G2 VARIO

IP54



Wind load area A = 0,13m²

Design:

Same as type 553... G2 but: With switch for for variable adjustment of the luminous flux in the luminaire.

Product highlights of the VARIO version:

- simple, fast, tool-free setting of the luminous flux on site, by means of integrated switch, can be changed at any time
- reduction in the variety of types



asymmetrical wide beam

colour temperature 3.000K (light colour 730)

55301 0001	553 L25 G2 VARIO	5 - 18	660 - 2.690	144	HST 35 - HST 50	7,0
55301 0002	553 L50 G2 VARIO	9 - 35	1.320 - 5.280	156	HST 35 - 2 x HST 70	7,1

colour temperature 3.000K (light colour 730)

55301 0003	553 L25 G2 VARIO 730	5 - 18	630 - 2.560	136	HST 35 - HST 50	7,0
55301 0004	553 L50 G2 VARIO 730	9 - 35	1.250 - 5.020	147	HST 35 - 2 x HST 70	7,1

symmetrical circular beam

colour temperature 4.000K (light colour 740)

55301 0005	553 L25R G2 VARIO	5 - 18	660 - 2.690	144	HST 35 - HST 50	7,0
55301 0006	553 L50R G2 VARIO	9 - 35	1.320 - 5.280	156	HST 35 - 2 x HST 70	7,1

colour temperature 3.000K (light colour 730)

55301 0007	553 L25R G2 VARIO 730	5 - 18	630 - 2.560	136	HST 35 - HST 50	7,0
55301 0008	553 L50R G2 VARIO 730	9 - 35	1.250 - 5.020	147	HST 35 - 2 x HST 70	7,1

Factory setting L25: 18 W; replaces approx. HME 80, HST 50

Factory setting L50: 18 W; replaces approx. HME 125, HST 70

1) possible setting range

* The given information is for rough orientation only. In each individual case a lighting calculation is necessary.



with ring mirror



with frosted board cover



with frosted board cover and ring mirror

Accessories / Spare Parts

Article no.	Type	
10051 9000	ABD 541/55. PMMA	cover, cylinder PMMA clear, for 541, 553, 556, 557, 558...
10041 9001	ABDP 54./55. C PMMA	board cover, diffuser for glare limitation, diffuser PMMA satined, for 541, 543, 553, 556, 557, 558...
90128 9001	DACH 542/43 POL M10	spare roof, polyester, for light fittings with integrated cover nut
90127 9000	DACH 542/43 AL RAL7035	spare roof, aluminium, with separate cover nut
90116 9004	RS 54./55. G2	ring mirror, aluminium for series 541, 543, 553, 556, 557, 558... (Design element)
90044 0001	RZ 1 GY	adapter for mast top Ø 60 mm



BELLA Pendant LED Light Fittings Series 564/565... G2

Applications:

Renewal of villages and historic city centres, low traffic areas, pedestrian areas, promenades, public parks.

Design:

Housing: Aluminium sheet, powder coated in DB 702.

Cover: Diffuser PMMA pearled

Electro kit: ECG and LED wired ready for connection, cable retainer for connection cable in housing.

Light distribution: Asymmetrical wide beam or symmetrical circular beam (R).

Mounting: To pole top sections with internal thread 3/4" (see accessories / spare parts).

Electrical design:

LED module: 4,000 K or 3,000 K, $R_a > 70$, service life $L_{95} > 100,000$ h, Zhaga compliant

ECG: 220-240 V, 50-60 Hz, Surge voltage resistance 10 kV, overload and short circuit protection.

Series 564... G2

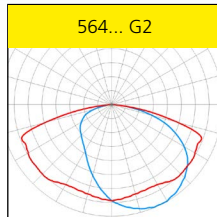
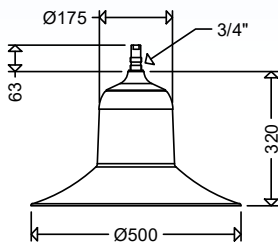

Series 565... G2

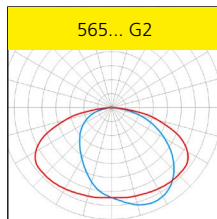
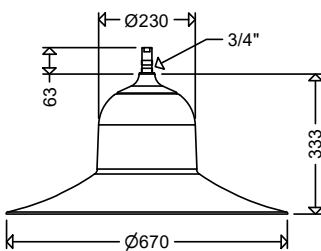

Options:

- 2,200 K; light colour (722)
- 1,800 K; light colour (518)
- asymmetrical extremely wide beam (RWX), for illuminating cycle paths
- special painting in RAL colours
- protection class I (SKI)
- seawater-resistant version
- for connection to a central power supply system (ZB)
- variable adjustable luminous flux via APP (NFC)
- dimming function via DALI-2 interface,

- compatible with LIMAS Line wired Light Management System (DIMD)
- power reduction with control phase (LR)
- power reduction without control phase (LA)
- constant luminous flux function (CL)
- inrush current limiter
- with backside light shielding (HA)
- for pole tops with a different internal thread, e.g. 1/2"

Product highlights:

- durable, corrosion-resistant aluminium housing with flat surface without cooling fins
- homogeneous illumination due to the Multi-Layer-Technology
- good glare limitation due to low-lying pearled cover
- tool-free replacement of ECG and LED module
- eco-friendly, no light emission into the upper half space, $ULOR=0$
- versions dimmable to 10% and with color temperature up to 3,000 K comply with Dark Sky requirements
- sustainable, control gear and LED-module replaceable by qualified personnel on-site
- future proof by using standardised LED-modules (Zhaga) and long-term availability of spare parts



! Properties, limitations and details for controlling LED-light fittings:

■ See "Technical Supplement"

All data are correct at the time of printing. Actual technical data can be found under www.schuch.de.

All light fittings also available with connected cable (H07RN-F or NYM) in the required length.

Article No.	Type	Connected load [W]	Luminous flux [lm]	Luminous efficacy [lm/W]	Weight [kg] (without packing material)
-------------	------	--------------------	--------------------	--------------------------	--

564... G2 / 565... G2

IP54



Wind load area A = 0,09m²

colour temperature 4.000K (light colour 740)

56400 0001	564 0801 G2	9	1.510	168	2,8
56400 0002	564 0802 G2	13	2.100	162	2,8
56400 0003	564 0803 G2	18	2.840	158	2,8
56400 0007	564 0801R G2	9	1.510	168	2,8
56400 0008	564 0802R G2	13	2.100	162	2,8
56400 0009	564 0803R G2	18	2.840	158	2,8
56400 0004	564 1601 G2	17	3.000	176	2,8
56400 0005	564 1602 G2	25	4.170	167	2,8
56400 0006	564 1603 G2	35	5.580	159	2,8
56400 0010	564 1601R G2	17	3.000	176	2,8
56400 0011	564 1602R G2	25	4.170	167	2,8
56400 0012	564 1603R G2	35	5.580	159	2,8
56500 0001	565 1601 G2	17	2.960	174	4,4
56500 0002	565 1602 G2	25	4.130	165	4,4
56500 0003	565 1603 G2	35	5.580	159	4,4
56500 0007	565 1601R G2	17	2.960	174	4,4
56500 0008	565 1602R G2	25	4.130	165	4,4
56500 0009	565 1603R G2	35	5.580	159	4,4
56500 0004	565 3201 G2	34	5.990	176	4,5
56500 0005	565 3202 G2	50	8.300	166	4,5
56500 0006	565 3203 G2	70	11.150	159	4,5
56500 0010	565 3201R G2	34	5.990	176	4,5
56500 0011	565 3202R G2	50	8.300	166	4,5
56500 0012	565 3203R G2	70	11.150	159	4,5

colour temperature 3.000K (light colour 730)

56400 0013	564 0801 G2 730	9	1.430	159	2,8
56400 0014	564 0802 G2 730	13	2.000	154	2,8
56400 0015	564 0803 G2 730	18	2.700	150	2,8
56400 0019	564 0801R G2 730	9	1.430	159	2,8
56400 0020	564 0802R G2 730	13	2.000	154	2,8
56400 0021	564 0803R G2 730	18	2.700	150	2,8
56400 0016	564 1601 G2 730	17	2.850	168	2,8
56400 0017	564 1602 G2 730	25	3.960	158	2,8
56400 0018	564 1603 G2 730	35	5.300	151	2,8
56400 0022	564 1601R G2 730	17	2.850	168	2,8
56400 0023	564 1602R G2 730	25	3.960	158	2,8
56400 0024	564 1603R G2 730	35	5.300	151	2,8
56500 0013	565 1601 G2 730	17	2.810	165	4,4
56500 0014	565 1602 G2 730	25	3.920	157	4,4
56500 0015	565 1603 G2 730	35	5.300	151	4,4
56500 0019	565 1601R G2 730	17	2.810	165	4,4
56500 0020	565 1602R G2 730	25	3.920	157	4,4
56500 0021	565 1603R G2 730	35	5.300	151	4,4
56500 0016	565 3201 G2 730	34	5.690	167	4,5
56500 0017	565 3202 G2 730	50	7.890	158	4,5
56500 0018	565 3203 G2 730	70	10.590	151	4,5
56500 0022	565 3201R G2 730	34	5.690	167	4,5
56500 0023	565 3202R G2 730	50	7.890	158	4,5
56500 0024	565 3203R G2 730	70	10.590	151	4,5

Outdoor Light Fittings

All light fittings also available with connected cable (see accessories in the data sheet).

Article No.	Type	Connected load [W]	Luminous flux [lm] ¹⁾	Luminous efficacy [lm/W] (up to)	Substitute for ca. *	Weight [kg] (without packing material)
-------------	------	--------------------	----------------------------------	----------------------------------	----------------------	--

564... G2 VARIO / 565... G2 VARIO



Wind load area A = 0,09m²

Design:

Same as type 564... G2 / 565... G2 but: With switch for for variable adjustment of the luminous flux in the luminaire.

Product highlights of the VARIO version:

- simple, fast, tool-free setting of the luminous flux on site, by means of integrated switch, can be changed at any time
- reduction in the variety of types



colour temperature 4.000K (light colour 740)

56401 0001	564 L25 G2 VARIO	5 - 18	690 - 2.840	168	HST 35 - HST 50	2,8
56401 0003	564 L25R G2 VARIO	5 - 18	690 - 2.840	168	HST 35 - HST 50	2,8
56401 0002	564 L50 G2 VARIO	9 - 35	1.390 - 5.580	178	HST 35 - 2 x HST 70	2,8
56401 0004	564 L50R G2 VARIO	9 - 35	1.390 - 5.580	178	HST 35 - 2 x HST 70	2,8
56501 0001	565 L50 G2 VARIO	9 - 35	1.360 - 5.580	176	HST 35 - 2 x HST 70	4,4
56501 0003	565 L50R G2 VARIO	9 - 35	1.360 - 5.580	176	HST 35 - 2 x HST 70	4,4
56501 0002	565 L100 G2 VARIO	16 - 70	2.760 - 11.150	178	HST 50 - HSE 150	4,5
56501 0004	565 L100R G2 VARIO	16 - 70	2.760 - 11.150	178	HST 50 - HSE 150	4,5

colour temperature 3.000K (light colour 730)

56401 0005	564 L25 G2 VARIO 730	5 - 18	660 - 2.700	159	HST 35 - HST 50	2,8
56401 0007	564 L25R G2 VARIO 730	5 - 18	660 - 2.700	159	HST 35 - HST 50	2,8
56401 0006	564 L50 G2 VARIO 730	9 - 35	1.320 - 5.300	169	HST 35 - 2 x HST 70	2,8
56401 0008	564 L50R G2 VARIO 730	9 - 35	1.320 - 5.300	169	HST 35 - 2 x HST 70	2,8
56501 0005	565 L50 G2 VARIO 730	9 - 35	1.290 - 5.300	167	HST 35 - 2 x HST 70	4,4
56501 0007	565 L50R G2 VARIO 730	9 - 35	1.290 - 5.300	167	HST 35 - 2 x HST 70	4,4
56501 0006	565 L100 G2 VARIO 730	16 - 70	2.620 - 10.590	169	HST 50 - HSE 150	4,5
56501 0008	565 L100R G2 VARIO 730	16 - 70	2.620 - 10.590	169	HST 50 - HSE 150	4,5

Factory setting L25: 18 W; replaces approx. HST 50

Factory setting L50: 18 W; replaces approx. HME 125, HST 70

1) possible setting range

Factory setting L100: 54 W; replaces approx. HME 250

* The given information is for rough orientation only. In each individual case a lighting calculation is necessary.



All light fittings also available with connected cable (see accessories in the data sheet).



Article no.	Type	Connected load [W]	Luminous flux [lm]	Luminous efficacy [lm/W]	Weight [kg] (without packing material)
-------------	------	--------------------	--------------------	--------------------------	--

RFL - Ready for Light Management Systems

Design:

Same as standard version 564... G2 / 565... G2, but prepared for the subsequent use of a Light Management System. Integrated sockets allows retrofitting of Light Management components without tools.

Product highlights:

- standardised Zhaga Book 18 compliant sockets with D4i control gear
- subsequent use of a light management system possible at any time
- tool-free, quick assembly of the Light Management System components

NEW

564... G2 / 565... G2 RFL

IP54



Wind load area A = 0,09m²

with a socket on the top and bottom side of the luminaire

colour temperature 4.000K (light colour 740)

56403 0001	564 0803 G2 RFLU	18	2.840	158	3,0
56403 0002	564 1603 G2 RFLU	35	5.580	159	3,0
56503 0001	565 1603 G2 RFLU	35	5.580	159	4,6
56503 0002	565 3203 G2 RFLU	70	11.150	159	4,7

colour temperature 3.000K (light colour 730)

56403 0003	564 0803 G2 730 RFLU	18	2.700	150	3,0
56403 0004	564 1603 G2 730 RFLU	35	5.300	151	3,0
56503 0003	565 1603 G2 730 RFLU	35	5.300	151	4,6
56503 0004	565 3203 G2 730 RFLU	70	10.590	151	4,7

Round arch pole-top adapter for pendant lights with upper thread 3/4"

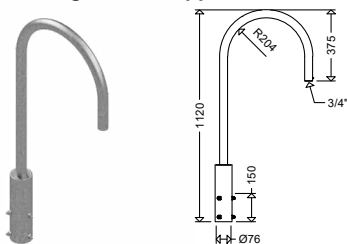

Article no.	Type	Description	Weight
61999 0001	MAU 619/1	for 1 fitting	8,8 kg

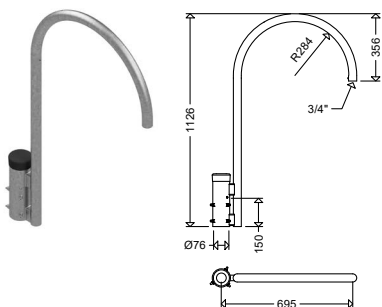

72299 0001	MAU 722/1	for 1 fitting	8,2 kg
72299 0002	MAU 722/2	for 2 fitting	14,0 kg
72299 0003	MAU 722/3	for 3 fittings	19,9 kg
72299 0004	MAU 722/4	for 4 fittings	25,7 kg

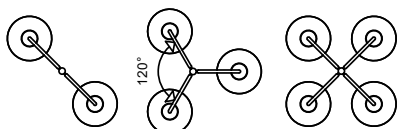

Tops also available painted to match luminaire color (SL).

System accessories

Article No.	Type	
90546 9018	RFL BM/DS IR12	RFL motion sensor with light sensor, infrared (maximum light point height 12.0 m)
90546 9004	RFL BM/DS IR8	RFL motion sensor with light sensor, infrared (light point height max. 8.0 m)
90546 9000	RFL DS20	RFL control element with light sensor, standalone, 20 lx
90543 0001	LASC DONGLE USB + SOFT + LIZ	LIMAS Air SYNC USB dongle with software and licence
90546 9012	RFL LASC BM RAD10 MA MK2	RFL LIMAS Air SYNC light management controller (2.4 GHz mesh network) with motion sensor, radar (mounting height max. 10.0 m) for mast mounting with 2.0 m cable
90546 9011	RFL LASC BM RAD8	RFL LIMAS Air SYNC light management controller (2.4 GHz mesh network) with motion sensor, radar (max. light point height 8.0 m)
90546 9014	RFL LASC DS	RFL LIMAS Air SYNC light management controller (2.4 GHz mesh network) with light sensor
90546 9010	RFL LASC DS GPS SIM	RFL LIMAS Air SYNC light management controller (2.4 GHz mesh network) with light sensor, GPS antenna and eSIM

Other sensors, e.g. environmental sensors (fine dust, CO₂, weather station etc.) on request.

Accessories / Spare Parts

Article no.	Type	
56410 0001	ABD 564 G2 P PMMA	cover, diffuser PMMA pearled, for 564... G2
56510 0001	ABD 565 G2 P PMMA	cover, diffuser PMMA pearled, for 565... G2

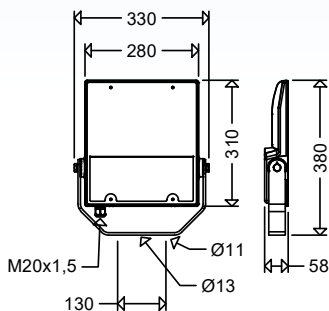

Swivel range

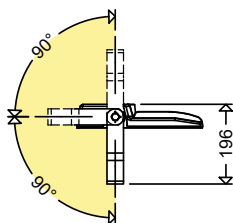

Standard Mounting

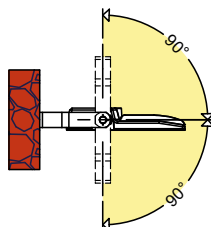

FOCO LED Floodlight with variable setting of the luminous flux Series 7600... VARIO / 7600 VARIO RFL

Applications:

Industrial areas, stockyards, terminals, object protection and fence illumination, construction zone, accent lighting, illumination of building and facades etc.

Design:

Housing: Die-cast aluminium, 1-part, powder coated DB 702 with LED-Module, optics (versions TB, T and A), electronic ballast and pressure compensation system.

Glass: Flat safety glass pane, resistant to temperature changes, impact resistant IK09, silicone gasket.

Switch for setting the luminous flux in the terminal compartment, accessible from the outside.

Light distribution: With optics narrow-wide (TB), narrow (T) or asymmetrical beam (A), without optics wide beam.

Connection: Terminal compartment, accessible from the outside, 3-pole terminal, max. clamping range 2.5 mm².

Cable entry: 1 cable entry M20 x 1.5 (1 cable gland).

Mounting: Mounting bracket, swivel range 180°, with 3 drillings for wall- or ceiling mounting.

Electrical design:

LED module: 4,000 K or 3,000 K, $R_a > 70$, service life $L_{95} > 100,000$ h, Zhaga compliant

ECG: 220-240 V, 50-60 Hz, Surge voltage resistance 10 kV, overload and short circuit protection.

Options:

- 2,200 K; light colour (722)
- 1,800 K; light colour (518)
- asymmetrical wide beam (AB)
- asymmetrical wide beam, low glare (ABL)
- extremely narrow beam (TX)
- cable looping at 1 small side
- special painting in RAL colours
- protection class II (SKII)
- seawater-resistant version
- vibration-resistant design
- high resistance (HR), against corrosive atmosphere
- bird deterrence
- for connection to a central power supply system (ZB)
- dimming function via DALI-2 interface, compatible with LIMAS Line wired Light Management System (DIMD)
- power reduction with control phase (LR)
- power reduction without control phase (LA)
- constant luminous flux function (CL)
- additional overvoltage protection
- extended swivel range
- inrush current limiter

Product highlights:

- durable, corrosion-resistant die-cast aluminium housing
- excellent thermal management, long service life
- quick electrical connection due to outlaying electrical connection box
- homogeneous illumination due to the **Multi-Layer-Technology**
- eco-friendly, no light emission into the upper half-space, ULOR=0 (Plane Surface Floodlight)
- versions dimmable to 10% and with color temperature up to 3,000 K comply with **Dark Sky requirements**
- sustainable, control gear and LED-module replaceable by qualified personnel on-site
- future proof by using standardised LED-modules (Zhaga) and long-term availability of spare parts
- GreenLine luminaire, outstanding sustainable design

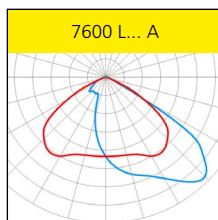
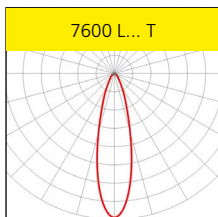
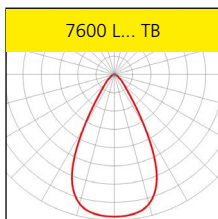
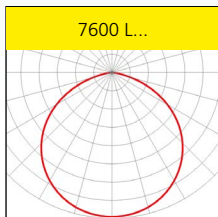

! Properties, limitations and details for controlling LED-light fittings:

■ See "Technical Supplement"

All data are correct at the time of printing. Actual technical data can be found under www.schuch.de.

All light fittings also available with connected cable (see accessories in the data sheet).

Article no.	Type	Power/ consumption [W]	Luminous flux [lm] ¹⁾	Luminous efficacy [lm/W] (up to)	Substitute for ca. *	Weight [ca. kg] (without packaging)
-------------	------	------------------------	----------------------------------	----------------------------------	----------------------	-------------------------------------

7600 ... VARIO



Design:

With switch for for variable adjustment of the luminous flux in the luminaire.

Product highlights of the VARIO version:

- simple, fast, tool-free setting of the luminous flux on site, by means of integrated switch, can be changed at any time
- reduction in the variety of types



colour temperature 4.000K (light colour 740)

76000 0102	7600 L50 VARIO	}	9 - 35	1.370 - 5.660	177	HST 35 - 2 x HST 70	3,8
76000 0104	7600 L50TB VARIO						
76000 0106	7600 L50T VARIO						
76000 0100	7600 L50A VARIO						
76000 0103	7600 L100 VARIO	}	16 - 70	2.740 - 11.170	177	HST 50 - HSE 150	3,8
76000 0105	7600 L100TB VARIO						
76000 0107	7600 L100T VARIO						
76000 0101	7600 L100A VARIO						

colour temperature 3.000K (light colour 730)

76000 0156	7600 L50 VARIO 730	}	9 - 35	1.300 - 5.380	168	HST 35 - 2 x HST 70	3,9
76000 0176	7600 L50TB VARIO 730						
76000 0177	7600 L50T VARIO 730						
76000 0122	7600 L50A VARIO 730						
76000 0137	7600 L100 VARIO 730	}	16 - 70	2.600 - 10.610	168	HST 50 - HSE 150	3,9
76000 0178	7600 L100TB VARIO 730						
76000 0133	7600 L100T VARIO 730						
76000 0117	7600 L100A VARIO 730						

Factory setting L50: 18 W; replaces approx. ca. HME 125, HST 70
¹⁾ possible setting range

Factory setting L100: 54 W; replaces approx. HME 250
 * The given information is for rough orientation only. In each individual case a lighting calculation is necessary.

All light fittings also available with connected cable (see accessories in the data sheet).

Article no.	Type	Power/ consumption [W]	Luminous flux [lm] ¹⁾	Luminous efficacy [lm/W] (up to)	Substitute for ca. *	Weight [ca. kg] (without packaging)
-------------	------	------------------------	----------------------------------	----------------------------------	----------------------	-------------------------------------

RFL - Ready for Light Management Systems

Design:

Same as standard version, but prepared for the subsequent use of a Light Management System. Integrated sockets allows retrofitting of Light Management components without tools.

Product highlights:

- standardised Zhaga Book 18 compliant sockets with D4i control gear
- subsequent use of a light management system possible at any time
- tool-free, quick assembly of the Light Management System components

RFL



7600 ... VARIO RFL



with a socket on the top side of the luminaire

The luminous flux is variably adjustable. The Connected load will change depending on the setting of the luminous flux.

colour temperature 4.000K (light colour 740)

76002 0002	7600 L50 VARIO RFLO	9 - 35	1.370 - 5.660	177	HST 35 - 2 x HST 70	3,8
76002 0003	7600 L50TB VARIO RFLO					
76002 0004	7600 L50T VARIO RFLO					
76002 0001	7600 L50A VARIO RFLO					

colour temperature 3.000K (light colour 730)

76002 0006	7600 L50 VARIO 730 RFLO	9 - 35	1.300 - 5.380	168	HST 35 - 2 x HST 70	3,8
76002 0007	7600 L50TB VARIO 730 RFLO					
76002 0008	7600 L50T VARIO 730 RFLO					
76002 0009	7600 L50A VARIO 730 RFLO					

Factory setting L50: 18 W; replaces approx. ca. HME 125, HST 70

* The given information is for rough orientation only. In each individual case a lighting calculation is necessary. 1) possible setting range

Single mounting: MAU 1 76/130 M10

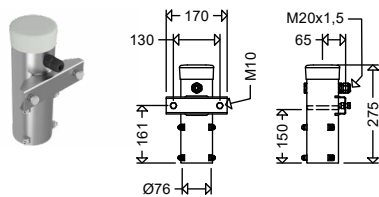

Double mounting: MAU 2 76/130 M10

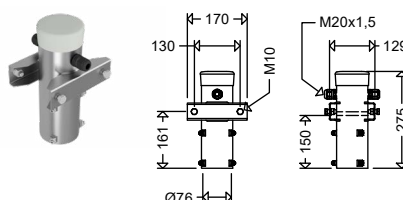

Threefold mounting: MAU 3 76/130 M10

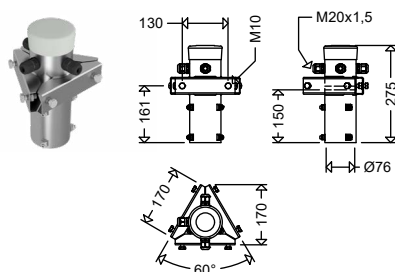

Fourfold mounting: MAU 4 76/130 M10

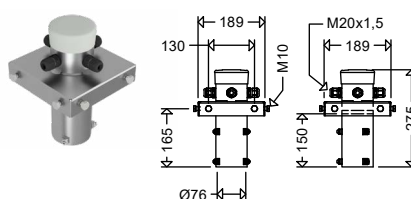

All pole top brackets made of galvanised steel. Painting in any RAL colour for additional charge.

System accessories

Article No.	Type	
90546 9000	RFL DS20	RFL control element with light sensor, standalone, 20 lx
90543 0001	LASC DONGLE USB + SOFT + LIZ	LIMAS Air SYNC USB dongle with software and licence
90546 9014	RFL LASC DS	RFL LIMAS Air SYNC light management controller (2.4 GHz mesh network) with light sensor
90546 9010	RFL LASC DS GPS SIM	RFL LIMAS Air SYNC light management controller (2.4 GHz mesh network) with light sensor, GPS antenna and eSIM

Other sensors, e.g. environmental sensors (fine dust, CO₂, weather station etc.) on request.

Accessories / Spare Parts

Article no.	Type	
76001 9000	ABD 7600 ESGW	cover, pane safety glass clear, for 7600...
75739 9006	MAU 1 76/130 M10	pole top for single mounting; galvanised steel
75739 9007	MAU 2 76/130 M10	pole top for dual mounting; galvanised steel
75739 9009	MAU 3 76/130 M10	pole top for threefold mounting; galvanised steel
75739 9008	MAU 4 76/130 M10	pole top for fourfold mounting; galvanised steel
90313 0001	KV M20 BK	plastic cable gland M20 x 1,5 black
90259 9002	DAE20	pressure compensation element M20 for ... AUS



FOCO L / FOCO XL LED Floodlight Series 7700... /7800...

Applications:

Industrial areas, stockyards, terminals, construction zone, accent lighting, large equipment for open-cast mining, illumination of building and facades etc.

Design:

Housing: Die-cast aluminium, 2-parts, powder coated DB 702,

Upper part: With LED- and optics-modules.

Lower part: With electronic ballast, glass cover, cable entry with cable relief and pressure compensation system, retractable.

Glass: Flat safety glass pane, resistant to temperature changes, impact resistant

IK10 (7700...) IK09 (7800...), silicone gasket.

Light distribution: With optics narrow-wide (TB), narrow (T) or asymmetrical beam (A), without optics wide beam.

Connection: 3-pole terminal, max. clamping range 2.5 mm².

Cable entry: 1 cable entry M20 x 1.5 or M25 x 1,5 (1 cable gland).

Mounting: Mounting bracket, swivel range 180°, with 3 drillings for wall- or ceiling mounting or for direct pole mounting in conjunction with pipe clamps **ROB 60/76 G2** (see accessories).

7700...

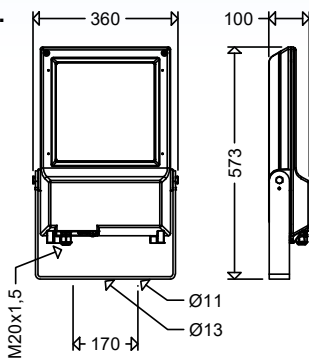

7800...

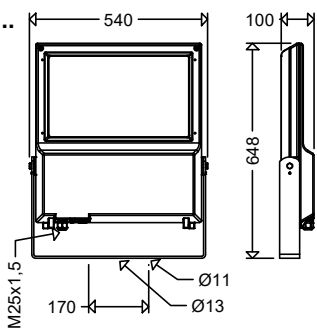

Swivel range

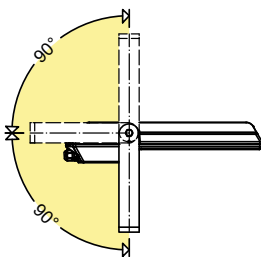

Standard Mounting

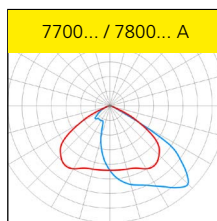
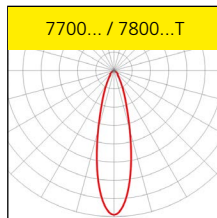
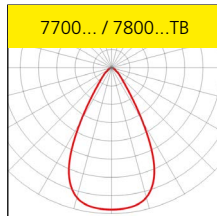
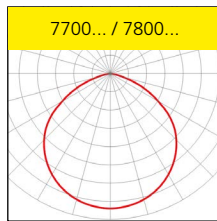
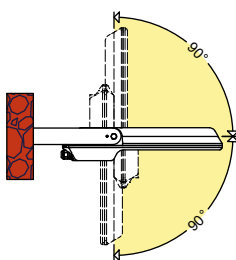

Electrical design:

LED module: 4,000 K or 3,000 K, $R_a > 70$, service life $L_{95} > 100,000$ h, Zhaga compliant

ECG: 220-240 V, 50-60 Hz, Surge voltage resistance 10 kV, overload and short circuit protection.

Options:

- 2,200 K; light colour (722)
- 1,800 K; light colour (518)
- asymmetrical wide beam (AB)
- asymmetrical wide beam, low glare (ABL)
- extremely narrow beam (TX)
- cable looping at 1 small side
- special painting in RAL colours
- protection class II (SKII)
- seawater-resistant version
- vibration-resistant design
- high resistance (HR), against corrosive atmosphere
- bird deterrence

- for connection to a central power supply system (ZB)
- dimming function via DALI-2 interface, compatible with LIMAS Line wired Light Management System (DIMD)
- power reduction with control phase (LR)
- power reduction without control phase (LA)
- constant luminous flux function (CL)
- EcoTune
- additional overvoltage protection
- extended swivel range
- inrush current limiter

Product highlights:

- durable, corrosion-resistant die-cast aluminium housing
- excellent thermal management, long service life
- comfortable maintenance due to removable lower part of the housing, large opening allows easy access to the terminal box and the electrical components
- homogeneous illumination due to the Multi-Layer-Technology
- eco-friendly, no light emission into the upper half-space, ULOR=0 (Plane Surface Floodlight)
- versions dimmable to 10% and with color temperature up to 3,000 K comply with Dark Sky requirements
- sustainable, control gear and LED-module replaceable by qualified personnel on-site
- future proof by using standardised LED-modules (Zhaga) and long-term availability of spare parts
- GreenLine luminaire, outstanding sustainable design

Properties, limitations and details for controlling LED-light fittings:

See "Technical Supplement"

All data are correct at the time of printing. Actual technical data can be found under www.schuch.de.

EcoTune luminaires from SCHUCH adapt flexibly to changing situations, taking into account safety, residents' interests and ecological aspects of night-time lighting. The luminaires combine either two light colours or optics: With light colours (e.g. 4,000 K and 2,200 K), the light can be changed from neutral white in the morning to warm white in the evening and optionally controlled via motion sensors, while the combination of two optics with different light distributions reduces glare on wet roads.

Further information on EcoTune can be found in our outdoor luminaires catalogue.

All light fittings also available with connected cable (see accessories in the data sheet).

Article No.	Type	Connected load [W]	Luminous flux [lm]	Luminous efficacy [lm/W]	Weight [kg] (without packing material)
-------------	------	--------------------	--------------------	--------------------------	--

7700 ... / 7800...



colour temperature 4.000K (light colour 740)

77000 0006	7700 3203	70	11.360	162	9,5
77000 0010	7700 3203TB				
77000 0014	7700 3203T				
77000 0002	7700 3203A				
77000 0007	7700 4803	106	16.790	158	9,7
77000 0011	7700 4803TB				
77000 0015	7700 4803T				
77000 0003	7700 4803A				
77000 0008	7700 6403	140	21.940	157	9,7
77000 0012	7700 6403TB				
77000 0016	7700 6403T				
77000 0004	7700 6403A				
78000 0011	7800 6403	140	22.650	162	15,9
78000 0001	7800 6403TB				
78000 0041	7800 6403T				
78000 0021	7800 6403A				
78000 0012	7800 12803	280	43.920	157	17
78000 0002	7800 12803TB				
78000 0042	7800 12803T				
78000 0022	7800 12803A				

colour temperature 3.000K (light colour 730)

77000 0198	7700 3203 730	70	10.790	154	9,5
77000 0199	7700 3203TB 730				
77000 0201	7700 3203T 730				
77000 0055	7700 3203A 730				
77000 0202	7700 4803 730	106	15.950	150	9,7
77000 0203	7700 4803TB 730				
77000 0157	7700 4803T 730				
77000 0058	7700 4803A 730				
77000 0099	7700 6403 730	140	20.840	149	9,7
77000 0116	7700 6403TB 730				
77000 0204	7700 6403T 730				
77000 0096	7700 6403A 730				
78000 0112	7800 6403 730	140	21.520	154	15,9
78000 0113	7800 6403TB 730				
78000 0114	7800 6403T 730				
78000 0050	7800 6403A 730				
78000 0115	7800 12803 730	280	41.720	149	17
78000 0057	7800 12803TB 730				
78000 0116	7800 12803T 730				
78000 0054	7800 12803A 730				



All light fittings also available with connected cable (see accessories in the data sheet).



All luminaires also available with luminous flux adjustment via app (NFC version).

Article no.	Type	Power/ consumption [W]	Luminous flux [lm] ¹⁾	Luminous efficacy [lm/W] (up to)	Substitute for ca. *	Weight [ca. kg] (without packaging)
-------------	------	------------------------	----------------------------------	----------------------------------	----------------------	-------------------------------------

7700... / 7800... VARIO



Design:

Same as type 7700... / 7800... but: With switch for for variable adjustment of the luminous flux in the luminaire.

Product highlights of the VARIO version:

- simple, fast, tool-free setting of the luminous flux on site, by means of integrated switch, can be changed at any time
- reduction in the variety of types



colour temperature 4.000K (light colour 740)

77001 0001	7700 L100 VARIO	16 - 70	2.760 - 11.360	179	HST 50 - HSE 150	9,5
77001 0003	7700 L100TB VARIO					
77001 0004	7700 L100T VARIO					
77001 0002	7700 L100A VARIO					
77001 0009	7700 L150 VARIO	24 - 106	4.120 - 1.6790	173	2 x HME 80 - 2 x HME 250	9,7
77001 0011	7700 L150TB VARIO					
77001 0012	7700 L150T VARIO					
77001 0010	7700 L150A VARIO					
77001 0017	7700 L210 VARIO	32 - 140	5.400 - 21.940	169	2 x HST 70 - HME 400	9,7
77001 0019	7700 L210TB VARIO					
77001 0020	7700 L210T VARIO					
77001 0018	7700 L210A VARIO					
78003 0001	7800 L210 VARIO	32 - 140	5.550 - 22.650	173	2 x HST 70 - HME 400	15,9
78003 0003	7800 L210TB VARIO					
78003 0004	7800 L210T VARIO					
78003 0002	7800 L210A VARIO					
78003 0009	7800 L420 VARIO	64 - 280	10.860 - 43.920	170	HSE 150 - 2 x HIE 400	17
78003 0011	7800 L420TB VARIO					
78003 0012	7800 L420T VARIO					
78003 0010	7800 L420A VARIO					

colour temperature 3.000K (light colour 730)

77001 0005	7700 L100 VARIO 730	16 - 70	2.620 - 10.790	171	HST 50 - HSE 150	9,5
77001 0007	7700 L100TB VARIO 730					
77001 0008	7700 L100T VARIO 730					
77001 0006	7700 L100A VARIO 730					
77001 0013	7700 L150 VARIO 730	24 - 106	3.910 - 15.950	164	2 x HME 80 - 2 x HME 250	9,7
77001 0015	7700 L150TB VARIO 730					
77001 0016	7700 L150T VARIO 730					
77001 0014	7700 L150A VARIO 730					
77001 0021	7700 L210 VARIO 730	32 - 140	5.130 - 20.840	160	2 x HST 70 - HME 400	9,7
77001 0023	7700 L210TB VARIO 730					
77001 0024	7700 L210T VARIO 730					
77001 0022	7700 L210A VARIO 730					
78003 0005	7800 L210 VARIO 730	32 - 140	5.270 - 21.520	165	2 x HST 70 - HME 400	15,9
78003 0007	7800 L210TB VARIO 730					
78003 0008	7800 L210T VARIO 730					
78003 0006	7800 L210A VARIO 730					
78003 0013	7800 L420 VARIO 730	64 - 280	10.320 - 41.720	161	HSE 150 - 2 x HIE 400	17
78003 0015	7800 L420TB VARIO 730					
78003 0016	7800 L420T VARIO 730					
78003 0014	7800 L420A VARIO 730					

Factory setting L100: 54 W; replaces approx. ca. HME 250
 Factory setting L150: 106 W; replaces approx. 2 x HME 250

Factory setting L210: 140 W; replaces approx. HME 400
 Factory setting L420: 280 W; replaces approx. 2 x HIE 400

1) possible setting range

* The given information is for rough orientation only. In each individual case a lighting calculation is necessary.

All light fittings also available with connected cable (see accessories in the data sheet).

Article No.	Type	Connected load [W]	Luminous flux [lm]	Luminous efficacy [lm/W]	Weight [kg] (without packing material)
-------------	------	--------------------	--------------------	--------------------------	--

RFL - Ready for Light Management Systems

Design:

Same as standard version 7700... / 7800... but prepared for the subsequent use of a Light Management System. Integrated sockets allows retrofitting of Light Management components without tools.

Product highlights:

- standardised Zhaga Book 18 compliant sockets with D4i control gear
- subsequent use of a light management system possible at any time
- tool-free, quick assembly of the Light Management System components

RFL



7700 ... / 7800... RFL

IP66



Wind load area A = 0,15m²

with a socket on the top and bottom side of the luminaire

colour temperature 4.000K (light colour 740)

77002 0057	7700 3203 RFL0U	70	11.360	162	9,5
77002 0031	7700 3203TB RFL0U				
77002 0058	7700 3203T RFL0U				
77002 0030	7700 3203A RFL0U				
77002 0059	7700 4803 RFL0U	106	16.790	158	9,7
77002 0060	7700 4803TB RFL0U				
77002 0061	7700 4803T RFL0U				
77002 0062	7700 4803A RFL0U				
77002 0063	7700 6403 RFL0U	140	21.940	157	9,7
77002 0064	7700 6403TB RFL0U				
77002 0065	7700 6403T RFL0U				
77002 0066	7700 6403A RFL0U				
78002 0041	7800 6403 RFL0U	140	22.650	162	15,9
78002 0042	7800 6403TB RFL0U				
78002 0043	7800 6403T RFL0U				
78002 0044	7800 6403A RFL0U				
78002 0045	7800 12803 RFL0U	280	43.920	157	17
78002 0046	7800 12803TB RFL0U				
78002 0047	7800 12803T RFL0U				
78002 0010	7800 12803A RFL0U				

colour temperature 3.000K (light colour 730)

77002 0067	7700 3203 730 RFL0U	70	10.790	154	9,5
77002 0068	7700 3203TB 730 RFL0U				
77002 0069	7700 3203T 730 RFL0U				
77002 0070	7700 3203A 730 RFL0U				
77002 0071	7700 4803 730 RFL0U	106	15.950	150	9,7
77002 0072	7700 4803TB 730 RFL0U				
77002 0073	7700 4803T 730 RFL0U				
77002 0074	7700 4803A 730 RFL0U				
77002 0075	7700 6403 730 RFL0U	140	20.840	149	9,7
77002 0076	7700 6403TB 730 RFL0U				
77002 0077	7700 6403T 730 RFL0U				
77002 0032	7700 6403A 730 RFL0U				
78002 0048	7800 6403 730 RFL0U	140	21.520	154	15,9
78002 0049	7800 6403TB 730 RFL0U				
78002 0050	7800 6403T 730 RFL0U				
78002 0020	7800 6403A 730 RFL0U				
78002 0051	7800 12803 730 RFL0U	280	41.720	149	17
78002 0052	7800 12803TB 730 RFL0U				
78002 0053	7800 12803T 730 RFL0U				
78002 0054	7800 12803A 730 RFL0U				

Outdoor Light Fittings

System accessories

Article No.	Type	
90546 9018	RFL BM/DS IR12	RFL motion sensor with light sensor, infrared (maximum light point height 12.0 m)
90546 9004	RFL BM/DS IR8	RFL motion sensor with light sensor, infrared (light point height max. 8.0 m)
90546 9000	RFL DS20	RFL control element with light sensor, standalone, 20 lx
90543 0001	LASC DONGLE USB + SOFT + LIZ	LIMAS Air SYNC USB dongle with software and licence
90546 9012	RFL LASC BM RAD10 MA MK2	RFL LIMAS Air SYNC light management controller (2.4 GHz mesh network) with motion sensor, radar (mounting height max. 10.0 m) for mast mounting with 2.0 m cable
90546 9011	RFL LASC BM RAD8	RFL LIMAS Air SYNC light management controller (2.4 GHz mesh network) with motion sensor, radar (max. light point height 8.0 m)
90546 9014	RFL LASC DS	RFL LIMAS Air SYNC light management controller (2.4 GHz mesh network) with light sensor
90546 9010	RFL LASC DS GPS SIM	RFL LIMAS Air SYNC light management controller (2.4 GHz mesh network) with light sensor, GPS antenna and eSIM

Other sensors, e.g. environmental sensors (fine dust, CO₂, weather station etc.) on request.

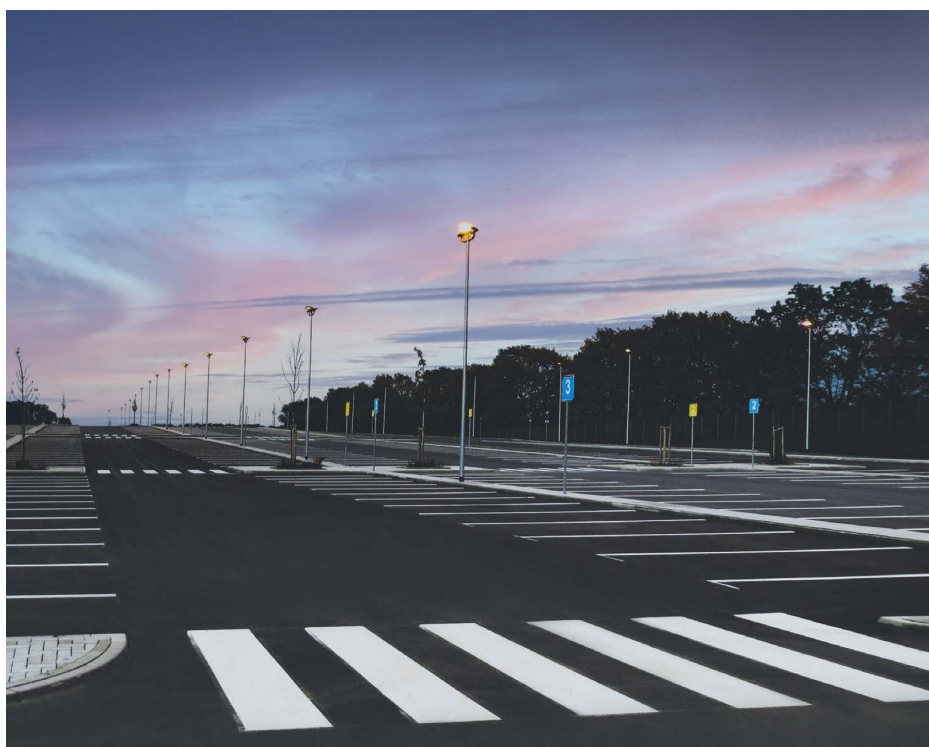

Pipe clamp fastening: **ROB 60/76 G2**

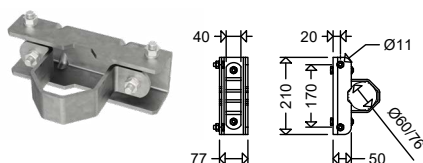

Single mounting: **MAU 1 76/170 M10**

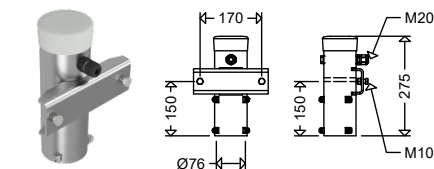

Double mounting: **MAU 2 76/170 M10**

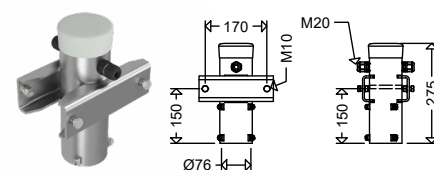

All pole top brackets made of galvanised steel. Painting in any RAL colour for additional charge.

Accessories / Spare Parts

Article no.	Type	
78001 9002	ABD 7700 ESGW	cover, pane safety glas clear, for 7700...
78001 9001	ABD 7800 ESGW	cover, pane safety glas clear, for 7800...
75739 9001	MAU 1 76/170 M10	Pole top for single mounting, Ø 76 mm, galvanised steel
75739 9002	MAU 2 76/170 M10	Pole top for double mounting, Ø 76 mm, galvanised steel
90270 0006	ROB 60/76 G2	pipe clamp for direct pole mounting or on multiple post top adapters; galvanised steel
79511 0006	TR 1200/76/170/5 M10/12	Crossbar with 5 fastening options for floodlights on a pole
79511 0007	TR 900/76/170/4 M10/12	Crossbar with 4 fastening options for floodlights on a pole
90313 0001	KV M20 BK	plastic cable gland M20 x 1,5 black for series 7700
90313 0002	KV M25 BK	plastic cable gland M25 x 1,5 black for series 7800
75350 0034	SD 7700 ST	vibration absorbing suspension device for series 7700, galvanised steel
75350 0033	SD 7800 ST	vibration absorbing suspension device for series 7800, galvanised steel

NEW

AREALO 2 LED Large-Area Spotlight Series 7950...



Applications:

Large areas such as car parks, storage areas, loading areas, loading stations, container terminals, harbour facilities, apron lighting at airports, open-cast mines, sports facilities, etc.

Design:

Housing: Die-cast aluminium, 1-part, powder-coated DB 702 with LED module, optics, ECG, cable entry and pressure compensation system.

Glass: Flat safety glass pane, resistant to temperature changes, impact resistant IK09, silicone gasket.

Light distribution: Extremely asymmetrical beam.

Connection: Connection compartment accessible from outside, terminal up to max. 2.5 mm².

Cable entry: 1 x M25 cable gland.

Mounting: Mounting bracket can be swivelled through 180° in 5° steps, with 3 holes for wall or ceiling mounting. Separate accessories are required for pole mounting (see accessories/spare parts).

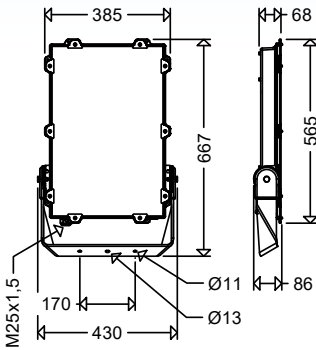

Swivel range

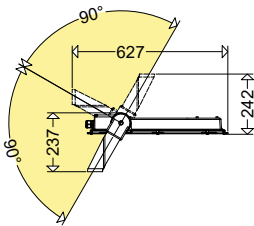

Standard Mounting

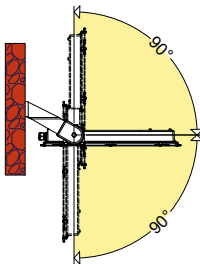

Electrical design:

LED module: 4,000 K or 3,000 K, $R_a > 70$, service life $L_{95} > 100,000$ h, Zhaga compliant

ECG: 220-240 V, 50-60 Hz, Surge voltage resistance 10kV, overload and short circuit protection.

Options:

- 2,200 K; light colour (722)
- 1,800 K; light colour (518)
- asymmetrical beam (A)
- special painting in RAL colours
- seawater-resistant version
- vibration-resistant design
- bird deterrence
- dimming function via DALI-2 interface

(DIMD)

- power reduction with control phase (LR)
- constant luminous flux function (CL)
- compatible with LIMAS Line and LIMAS Air Light Management System

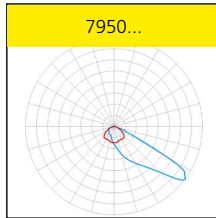

Product highlights:

- durable, corrosion-resistant die-cast aluminium housing
- low total weight, low mast load
- excellent thermal management, long service life
- quick electrical connection due to outlying electrical connection box
- homogeneous illumination due to the Multi-Layer-Technology
- eco-friendly, no light emission into the upper half-space, $ULOR=0$
- versions dimmable to 10% and with color temperature up to 3,000 K comply with Dark Sky requirements
- sustainable, control gear and LED-module replaceable by qualified personnel on-site
- future proof by using standardised LED-modules (Zhaga) and long-term availability of spare parts
- GreenLine luminaire, outstanding sustainable design



Outdoor
Light Fittings

! Properties, limitations and details for controlling LED-light fittings:

■ See "Technical Supplement"

All data are correct at the time of printing. Actual technical data can be found under www.schuch.de.

All light fittings also available with connected cable (see accessories in the data sheet).

Article No.	Type	Connected load [W]	Luminous flux [lm]	Luminous efficacy [lm/W]	Weight [kg] (without packing material)
-------------	------	--------------------	--------------------	--------------------------	--

7950... SP OP



Version OP:

Additional overvoltage protection in the luminaire.

colour temperature 4.000K (light colour 740)

79500 0001	7950 14401SP OP	144	26.500	184	10,7
79500 0003	7950 14402SP OP	209	36.800	176	10,7
79500 0005	7950 14403SP OP	298	49.300	165	11,0
79500 0007	7950 14404SP OP	432	66.500	154	11,0
79500 0002	7950 14401SP DIMD OP	144	26.500	184	10,7
79500 0004	7950 14402SP DIMD OP	209	36.800	176	10,7
79500 0006	7950 14403SP DIMD OP	298	49.300	165	11,0
79500 0008	7950 14404SP DIMD OP	432	66.500	154	11,0

colour temperature 3.000K (light colour 730)

79500 0009	7950 14401SP 730 OP	144	25.200	175	10,7
79500 0011	7950 14402SP 730 OP	209	35.000	167	10,7
79500 0013	7950 14403SP 730 OP	298	46.800	157	11,0
79500 0015	7950 14404SP 730 OP	432	63.200	146	11,0
79500 0010	7950 14401SP DIMD 730 OP	144	25.200	175	10,7
79500 0012	7950 14402SP DIMD 730 OP	209	35.000	167	10,7
79500 0014	7950 14403SP DIMD 730 OP	298	46.800	157	11,0
79500 0016	7950 14404SP DIMD 730 OP	432	63.200	146	11,0

RFL - Ready for Light Management Systems

Design:

Same as standard version 7950... SP OP but prepared for the subsequent use of a Light Management System. Integrated sockets allows retrofitting of Light Management components without tools.

Product highlights:

- standardised Zhaga Book 18 compliant sockets with D4i control gear
- subsequent use of a light management system possible at any time
- tool-free, quick assembly of the Light Management System components



7950... SP OP RFL



with a socket on the top side of the luminaire

colour temperature 4.000K (light colour 740)

79501 0001	7950 14404SP OP RFLSO	432	66.500	154	11,0
------------	-----------------------	-----	--------	-----	------

colour temperature 3.000K (light colour 730)

79501 0002	7950 14404SP 730 OP RFLSO	432	63.200	146	11,0
------------	---------------------------	-----	--------	-----	------

System accessories

Article No.	Type	
79511 0009	VBOX RFL TR	Distribution box with RFL socket for crossbar mounting
90547 9011	LACA TAST4 AP	LIMAS Air CASA 4-gang push button
90547 9009	LACA TASTIF4 UP	LIMAS Air CASA push button interface 4-gang flush-mounted
90546 9013	RFL LACA DS	RFL LIMAS Air CASA wireless module with light sensor

All light fittings also available with connected cable (see accessories in the data sheet).

Article No.	Type	Connected load [W]	Luminous flux [lm]	Luminous efficacy [lm/W]	Weight [kg] (without packing material)
-------------	------	--------------------	--------------------	--------------------------	--

7950... SP OV



Version:

Like 7950... SP OP but without ballasts (OV), separate ECG unit 7950 required.
Please order in combination.

colour temperature 4.000K (light colour 740)

79502 0200	7950 14401SP OV	144	26.500	184	10,3
79502 0201	7950 14402SP OV	209	36.800	176	10,3
79502 0202	7950 14403SP OV	298	49.300	165	10,3
79502 0203	7950 14404SP OV	432	66.500	154	10,3

colour temperature 3.000K (light colour 730)

79502 0204	7950 14401SP 730 OV	144	25.200	175	10,3
79502 0205	7950 14402SP 730 OV	209	35.000	167	10,3
79502 0206	7950 14403SP 730 OV	298	46.800	157	10,3
79502 0207	7950 14404SP 730 OV	432	63.200	146	10,3

Typ 1 / Typ 2

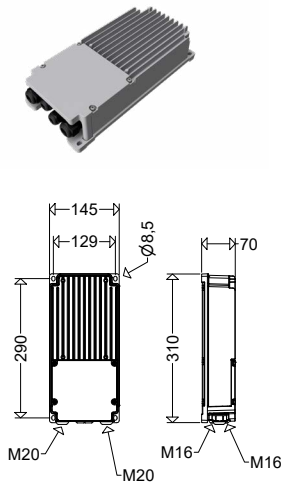

Typ 4

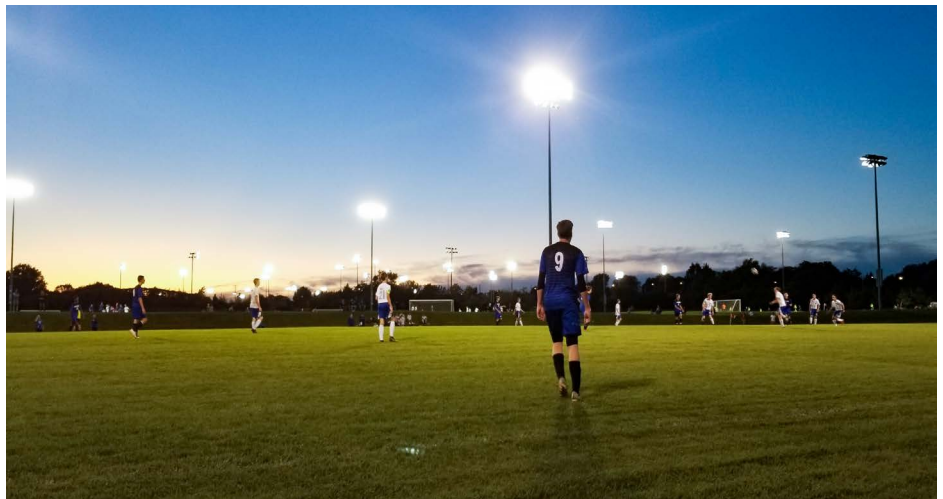
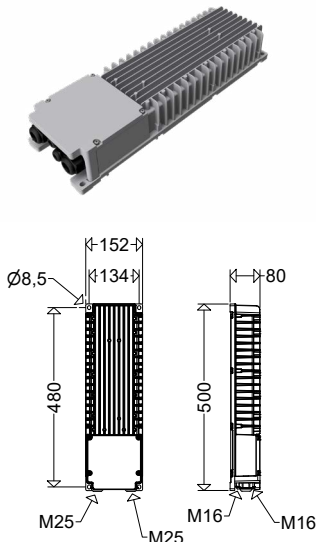

Internal pole mounting unit 7850 ME 1000



Design:

ECG for direct mounting with 4 screws

Connection: Direct connection of the cables in the connection compartment of the ECG; access to the connection compartment by loosening 4 screws.

Article no.	Type		EVG	Weight [ca. kg] (without packaging)
79512 0001	EVG 7950 1 14401 OV	ECG unit for one luminaire 7950 14401 OV	Typ 1	3,1
79512 0002	EVG 7950 2 14401 OV	ECG unit for two luminaires 7950 14401 OV	Typ 1	3,1
79512 0003	EVG 7950 3 14401 OV	ECG unit for three luminaires 7950 14401 OV	Typ 1	3,1
79512 0004	EVG 7950 1 14402 OV	ECG unit for one luminaire 7950 14401 OV	Typ 1	3,1
79512 0005	EVG 7950 2 14402 OV	ECG unit for two luminaires 7950 14401 OV	Typ 1	3,1
79512 0006	EVG 7950 3 14402 OV	ECG unit for three luminaires 7950 14401 OV	Typ 2	3,4
79512 0007	EVG 7950 1 14403 OV	ECG unit for one luminaire 7950 14401 OV	Typ 1	3,1
79512 0008	EVG 7950 2 14403 OV	ECG unit for two luminaires 7950 14401 OV	Typ 1	3,1
79512 0009	EVG 7950 3 14403 OV	ECG unit for three luminaires 7950 14401 OV	Typ 2	3,4
79512 0010	EVG 7950 1 14404 OV	ECG unit for one luminaire 7950 14401 OV	Typ 1	3,1
79512 0011	EVG 7950 2 14404 OV	ECG unit for two luminaires 7950 14401 OV	Typ 2	3,4
79512 0012	EVG 7950 3 14404 OV	ECG unit for three luminaires 7950 14401 OV	Typ 4	6,4
79512 0013	EVG 7950 4 14404 OV	ECG unit for four luminaires 7950 14401 OV	2 x Typ 2	6,8

Single mounting: MAU 1 76/170 M10

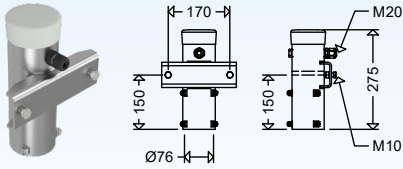

Double mounting: MAU 2 76/170 M10

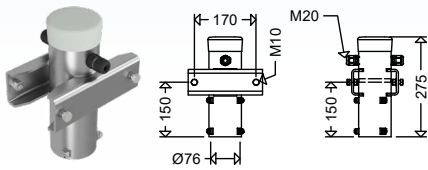

TR 1200/108/170/5 M10/12

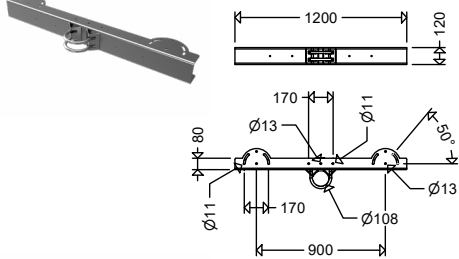

TR 900/108/170/4 M10/12

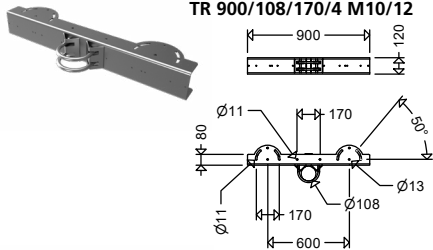

TR 1200/76/170/5 M10/12

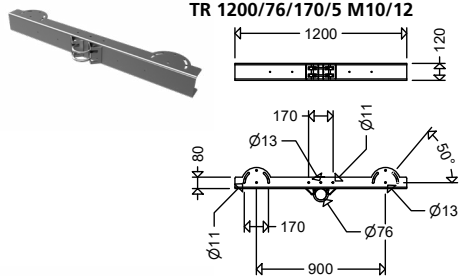

TR 900/76/170/4 M10/12

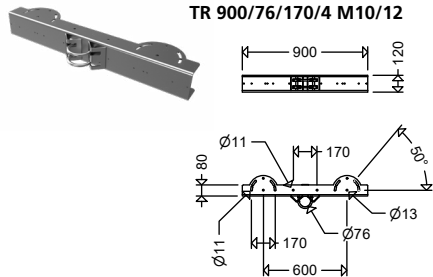

Accessories / Spare Parts

Article no.	Type	
79510 0001	ABD 7950 ESGW	cover, pane safety glas clear, for 7950...
75739 9001	MAU 1 76/170 M10	Pole top for single mounting, Ø 76 mm, galvanized steel
75739 9002	MAU 2 76/170 M10	Pole top for double mounting, Ø 76 mm, galvanized steel
90313 0003	KV25 G BK	plastic cable gland M25 x 1,5 black
79511 0003	SD 7950 ST	vibration absorbing suspension device for series 7950, galvanised steel
79511 0001	TR 1200/108/170/5 M10/12	Crossbar with 5 fastening options for floodlights on a pole
79511 0004	TR 900/108/170/4 M10/12	Crossbar with 4 fastening options for floodlights on a pole
79511 0006	TR 1200/76/170/5 M10/12	Crossbar with 5 fastening options for floodlights on a pole
79511 0007	TR 900/76/170/4 M10/12	Crossbar with 4 fastening options for floodlights on a pole
79511 0002	VBOX 5 TR	Distribution box for combining the connection cables of several AREALO 2 units. 6 loose cable glands, support plate and screws for direct attachment to the crossbar included in the scope of delivery.
79511 0005	MABD 108	Pole cover Ø 108 mm with strain relief and 4 cable entries
79511 0010	BFSET M10/M12	Fastening set for traverse mounting with 2 M10 screw connections 1 M12 screw connection
79511 0008	BD 7950	dird defence stainless steel for 7950

All pole fastenings made of galvanized steel. Painting in any RAL colour for additional charge.

INTELLIGENT LIGHT CONTROL AT SPORTS FACILITIES

Simply switching the floodlights of a sports facility on and off is neither efficient nor cost-saving and environmentally friendly. When converting to LED technology, the question of intelligent lighting control therefore arises.

If one then takes into account the subsidies from the federal government within the framework of the municipal guidelines as well as the state sports associations and possibly the respective federal state, which can currently

amount to up to 80 % cumulatively at peak times, the decision should not be difficult.

Dimming

The introduction to light control

The simplest solution is to dim the floodlights via DALI. Since the maximum illuminance is usually only required for matches and competitions, energy can be saved to a considerable extent by continuously dimming or switching on preset

lighting levels during training. All that is required for this are AREALO 2 luminaires in DIMD design and DALI wiring to the masts.



Outdoor
Light Fittings

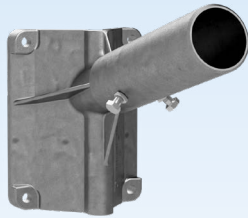

4861

Cast Aluminium Multi-Purpose Pole Arm Carrier Series 4861, 4864

Application: Series 42, 46, 47, 48, 51, 52

Applications:

For mounting outdoor light fittings on flat walls and corners of buildings.

Design:

Aluminium casting: Natural finish, with four fixing holes $\varnothing 10,5$ mm, and carrier shaft for galvanized steel pole arms.

Pole arm: $\varnothing 60$ mm (100 or 250 mm long), with 2 fixing screws M8

Pole arm assembly:

The $\varnothing 42$ mm pole arm is pushed into the carrier shaft, the $\varnothing 60$ mm pole arm is slipped over the carrier shaft. The pole arm is secured with 2 screws M8 (included in supply).

Options:

Special painting in RAL colours (SL)

4861/64

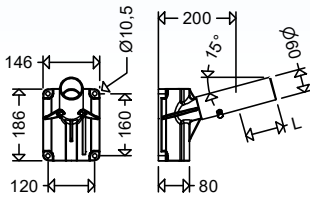

4861, 4864

Article no.	Type	D	L	Weight ca. [kg]
48600 0002	4861	60	100	1,7
48600 0005	4864	60	250	2,5



4871 RAL7035



4871 DB 702

Welded Aluminium Standard Pole Arm Carrier Series 4871

Application: Series 42, 46, 47, 48, 51, 52

Applications:

For mounting outdoor light fittings on flat walls and corners of buildings.

Design:

Aluminium plate 4 mm thick, powder coated grey (RAL 7035) or mica-iron (DB 702), with eight fixing holes $\varnothing 9$ mm and pole arm $\varnothing 60$ mm (100 mm long).

Options:

Special painting in RAL colours (SL)

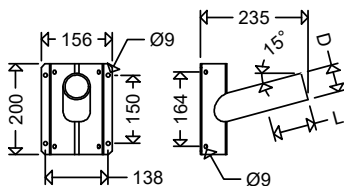

4871

Article no.	Type	D	L	Weight ca. [kg]
48700 0002	4871 RAL7035	60	100	0,7
48700 0504	4871 DB703	60	100	0,7
48700 0506	4871 DB702	60	100	0,7

BestSelect – a selection of tried-and-tested SCHUCH articles for your everyday needs. More at: www.schuch.de/BestSelect

Pole-Top Brackets

All pole-top and wall brackets with the exception of the aluminium tubular brackets are made from galvanised steel.

Powder coating in any RAL colour is possible at extra charge.

MAU 601/1

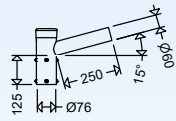
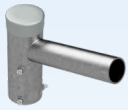

MAU 610/1

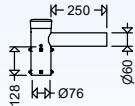
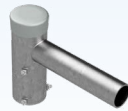

MAU 1 76/170 M10

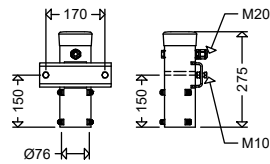

MAU 2 76/170 M10

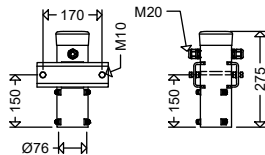

MAU 1 76/130 M10

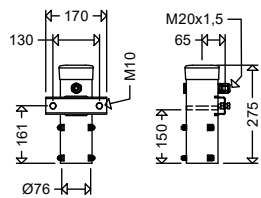

MAU 2 76/130 M10

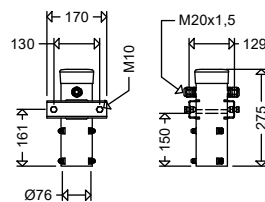

MAU 3 76/130 M10

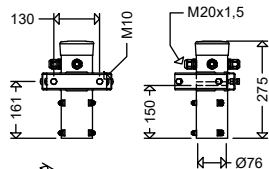

MAU 4 76/130 M10

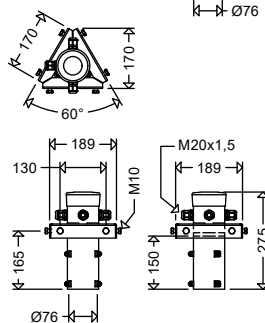

Article No.	Type	Description	Weight ca. [kg]	for following light fittings:
-------------	------	-------------	-----------------	-------------------------------

Pole-top brackets Ø 60 mm

60199 0001	MAU 601/1	for 1 fitting	3,7	42, 46, 47, 48, 51, 52
60199 0002	MAU 601/2	for 2 fittings	5,1	
60199 0003	MAU 601/3	for 3 fittings	6,5	
60199 0004	MAU 601/4	for 4 fittings	7,9	

Pole-top brackets Ø 60 mm

61099 0001	MAU 610/1	for 1 fitting	3,7	42, 46, 47, 48, 51, 52
61099 0002	MAU 610/2	for 2 fittings	5,1	
61099 0003	MAU 610/3	for 3 fittings	6,5	
61099 0004	MAU 610/4	for 4 fittings	7,9	

Pole-top Ø 76 mm, galvanised steel

75739 9001	MAU 1 76/170 M10	for 1 fitting	3,0	7700, 7800,
75739 9002	MAU 2 76/170 M10	for 2 fittings	3,8	7950

Pole-top Ø 76 mm, galvanised steel

75739 9006	MAU 1 76/130 M10	for 1 fitting	2,4	7600
75739 9007	MAU 2 76/130 M10	for 2 fittings	2,7	
75739 9009	MAU 3 76/130 M10	for 3 fittings	3,0	
75739 9008	MAU 4 76/130 M10	for 4 fittings	3,0	

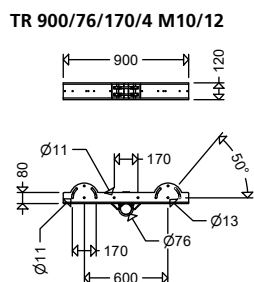
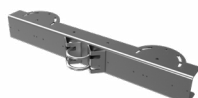
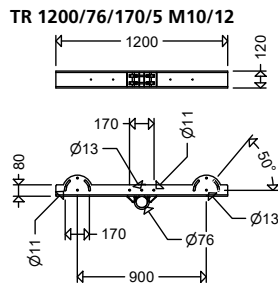
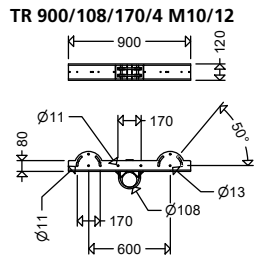
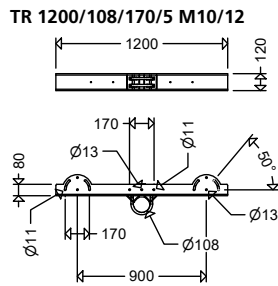
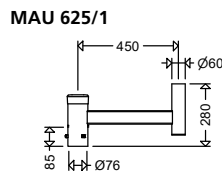
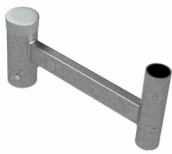
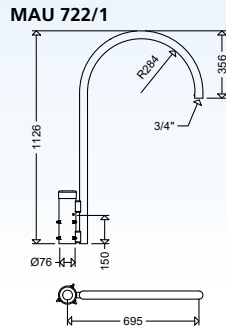
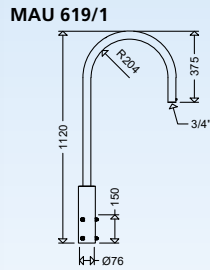

Pole-Top Brackets

Powder coating in any RAL colour is possible at extra charge.

Article No.	Type	Description	Weight ca. [kg]	for follwing light fittings:
Pole-top				
61999 0001	MAU 619/1		8,8	564, 565

Article No.	Type	Description	Weight ca. [kg]	for follwing light fittings:
Pole-top				
72299 0001	MAU 722/1	for 1 fitting	8,2	564, 565
72299 0002	MAU 722/2	for 2 fittings	14,0	
72299 0003	MAU 722/3	for 3 fittings	19,9	
72299 0004	MAU 722/4	for 4 fittings	25,7	

Article No.	Type	Description	Weight ca. [kg]	for follwing light fittings:
Pole-top				
62599 0001	MAU 625/1	for 1 fitting	4,6	541, 542, 543, 553, 556, 557, 558, 544, 46, 47, 48, 51, 52
62599 0002	MAU 625/2	for 2 fittings	7,0	
62599 0003	MAU 625/3	for 3 fittings	9,4	
62599 0004	MAU 625/4	for 4 fittings	11,8	

Crossbars

Article No.	Type	Description	for follwing light fittings:
79511 0001	TR 1200/108/170/5 M10/12	Crossbar with 5 fastening options for floodlights on a pole	7700, 7800, 7950
79511 0004	TR 900/108/170/4 M10/12	Crossbar with 4 fastening options for floodlights on a pole	
79511 0006	TR 1200/76/170/5 M10/12	Crossbar with 5 fastening options for floodlights on a pole	
79511 0007	TR 900/76/170/4 M10/12	Crossbar with 4 fastening options for floodlights on a pole	

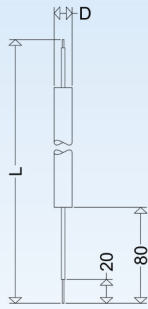

Connection cable

The H07RN-F rubber hose cable with flexible conductors and pre-assembled wire end ferrules is connected to the luminaire in the desired length upon delivery.

The cable is flame-retardant and resistant to oil, ozone and UV radiation. It is therefore suitable for permanent use in outdoor areas, but also for installation in dry, damp and wet rooms.

Article No.	Type	Length L [m]	Ø / Width D [mm]	Weight [kg]
99100 0040	AKB 4,0m H07RN-F 3G1,5	4,0	9,40	0,6
99100 0041	AKB 4,5m H07RN-F 3G1,5	4,5	9,40	0,7
99100 0042	AKB 5,0m H07RN-F 3G1,5	5,0	9,40	0,8
99100 0044	AKB 6,0m H07RN-F 3G1,5	6,0	9,40	0,9
99100 0046	AKB 7,0m H07RN-F 3G1,5	7,0	9,40	1,1
99100 0048	AKB 8,0m H07RN-F 3G1,5	8,0	9,40	1,2
99100 0050	AKB 9,0m H07RN-F 3G1,5	9,0	9,40	1,4
99100 0052	AKB 10,0m H07RN-F 3G1,5	10,0	9,40	1,6
99100 0056	AKB 12,0m H07RN-F 3G1,5	12,0	9,40	1,9
99100 0074	AKB 5,0m H07RN-F 4G1,5	5,0	11,50	1,2
99100 0076	AKB 6,0m H07RN-F 4G1,5	6,0	11,50	1,4
99100 0078	AKB 7,0m H07RN-F 4G1,5	7,0	11,50	1,6
99100 0080	AKB 8,0m H07RN-F 4G1,5	8,0	11,50	1,8
99100 0082	AKB 9,0m H07RN-F 4G1,5	9,0	11,50	2,1
99100 0084	AKB 10,0m H07RN-F 4G1,5	10,0	11,50	2,3
99100 0088	AKB 12,0m H07RN-F 4G1,5	12,0	11,50	2,8



Emergency Light Fittings

Reliability in severe environment

Darkness means fear. Especially in buildings with a lot of people inside, panic will come up if the light fails.

For this reason and according to the relevant laws and standards, an emergency lighting system must be installed.

Due to special operating conditions, emergency light fitting design shall comply with particular requirements.

WIDE RANGE OF PRODUCTS, INCLUDING SPECIAL SOLUTIONS.

SCHUCH offers optimal solutions for each specific application of an emergency lighting system, e.g. highly dangerous work places and escape routes.

A wide range of products is available: From light fittings with built-in batteries to group and central power supply systems connected ones.

An emergency version is available for almost each light fitting out of the wide range of SCHUCH products.

Applications with harsh conditions, such as high ambient temperatures or extreme variations in temperature, consistently challenge us to develop new custom-built solutions. Ambient temperatures of +50 °C are often observed at power plants, waste incineration plants, recycling plants, chemical factories, as well as commercial kitchens, bakeries, etc. In such cases, SCHUCH light fittings can also help safely illuminate and indicate any escape route.

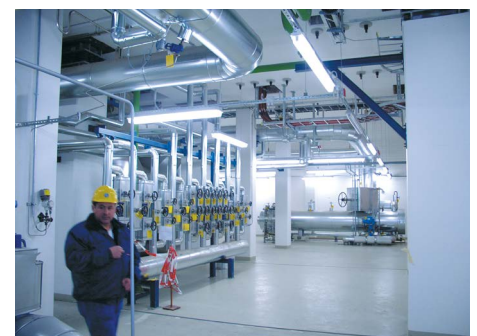

Emergency Light Fittings

Product	Series	Page
Lightmanagement		
according to DIN EN 50172 VDE 0108-100:2024-10		
LIMAS Line PRO - Wired light management system with emergency lighting monitoring and building management integration		230
LIMAS Line ESC - Wired system for central monitoring of emergency lights		231
LIMAS Air GUARD - Radio-based monitoring system for self-contained emergency luminaire		231
Light fittings with diffuser		
PROXIMA	161PX...	232-233
• self-contained emergency light fitting with automatic monitoring	... MA	233
• for central power supply systems	... ZB	233
• self-contained emergency light fitting with automatic monitoring for high ambient temperatures up to +50 °C	... H50 MA	234-235
Series 161...	161...	236-237
• self-contained emergency light fitting with automatic monitoring	... MA	237
• for central power supply systems	... ZB	237
Series 163... Generation 2	163... G2	238-239
• self-contained emergency light fitting with automatic monitoring	... MA	239
• for central power supply systems	... VARIO ZB	239
LUXANO 2	167... G2	240-241
• self-contained emergency light fitting with automatic monitoring	... MA	241
• for central power supply systems	... VARIO ZB	241
Series 164 KL... <i>small polyester light fittings</i>	164 KL...	242-243
• self-contained emergency light fitting with automatic monitoring	... MA	242
• for central power supply systems	... ZB	243
Series 131... <i>small PC-light fittings</i>	131...	244-245
• self-contained emergency light fitting with automatic monitoring	... W MA	245
• for central power supply systems	... ZB	245
Series 3611... <i>small die-cast aluminium light fittings</i>	3611...	246-247
• self-contained emergency light fitting with automatic monitoring	... MA	246
• for central power supply systems	... ZB	247
Note:		
Emergency light fittings for zone 1/2 or 21/22 areas you may find in chapter „SCHUCH Explosion-Protected LED Light Fittings“		
Emergency light fittings for other applications on demand.		

LED TECHNOLOGY

2005

Introduction of first self-contained emergency light fitting with the new LED technology.

2011

Production of the first explosion protected self-contained LED emergency light fitting.

2015

Expansion of the product range to include self-contained LED emergency light fitting for high ambient temperatures up to +50 °C.

2017-2019

Due to their low energy consumption, light fittings in ZB design for connection to centralised safety power supply systems are becoming increasingly important.

2020/2021

Introduction of the **LIMAS Line** light management system for smart control and central monitoring of wired, DALI-capable, self-contained emergency light fittings in accordance to DIN VDE V 0108-100-1.

2022/2023

A legend turns 50! With the **PROXIMA 161PX...** SCHUCH presents the next generation of the legendary 161... dustproof/waterproof light fitting series, including the self-contained emergency light fitting for temperatures up to +50 °C.

2025

With the introduction of the wireless **LIMAS Air GUARD** Light Management System for centralised monitoring and control of self-contained emergency light fitting, we are rounding off our range of smart solutions.



Photo: BASF

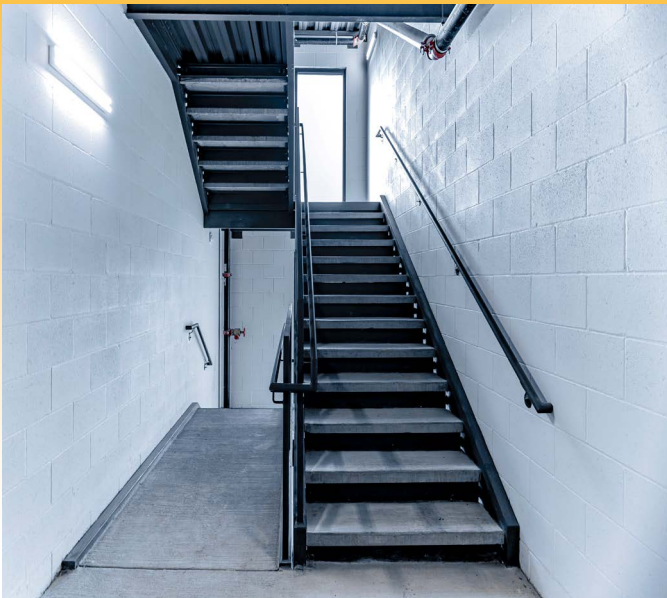











The LIMAS Line PRO light management system turns any self-powered emergency luminaire into an intelligent solution. DIMD MA-Z luminaires can be both monitored and controlled via DALI.

MA-Z luminaires, on the other hand, can only be monitored via DALI, but not controlled. The system also enables function and duration tests to be carried out at individually definable times and offers a central monitoring option in accordance with DIN EN 50172 VDE 0108-100:2024-10.

Configuration and control are carried out via PC without additional software - a browser is all that is needed. The connection between the PC and LIMAS Line PRO can be realised either via an existing network or by establishing a peer-to-peer connection. An Internet connection is not required.

For further details and properties, see the chapter on light management systems.

System accessories



Type	Art.-No.		
LL BM/DS HF4	90545 0040	High-frequency DALI-2 motion sensor with integrated light sensor for mounting heights of 2.0 – 4.0 m and a maximum detection range of 8.0 m in diameter	
LL BM/DS IR14	90545 0036	Infrared DALI-2 motion sensor with integrated light sensor for mounting heights of 4.0 - 14.0 m	
LL BM/DS IR16	90545 0037	Infrared DALI-2 motion sensor with integrated light sensor for mounting heights of 4.0 - 16.0 m	
LL BM/DS IR3	90545 0038	Infrared DALI-2 motion sensor with integrated light sensor for vertical wall mounting, suitable for installation heights of 1.8 – 2.5 m	
LL BM/DS IR4	90545 0035	Infrared DALI-2 motion sensor with integrated light sensor for mounting heights of 2.5 – 4.0 m	
LL BM/DS IR5	90545 0039	Infrared DALI-2 motion sensor with integrated light sensor for mounting heights of 2.5 – 5.0 m and a maximum detection range of 6.0 m x 23.0 m	
LL DALI PS240	90545 0016	DALI bus power supply with up to 240 mA maximum output current	
LL TASTIF4 UP	90545 0015	DALI-2 push-button interface for connecting up to 4 volt-free push-button inputs. Designed for installation in a flush-mounted wall box	
LLPO AKTOR 4X10	90545 0041	DALI-2 actuator with 4 volt-free outputs (max. 10 A). Suitable for signaling test states and system statuses of self-contained emergency luminaires	
LLPO CON	90545 0031	DALI-2 controller for controlling up to 192 devices across 3 DALI buses. Monitoring of self-contained emergency luminaires possible	



Wired system for central monitoring of emergency lights

The LIMAS Line ESC light management system is suitable for centralised monitoring of self-contained MA-Z emergency luminaires. These luminaires can be monitored via DALI in accordance with DIN EN 50172 VDE 0108-100:2024-10, but not controlled. They are operated via the integrated touchscreen panel; a PC is not required. The system also enables function and duration tests to be carried out at individually definable times. For further details and properties, see the chapter on light management systems.

System accessories

Type	Art.-No.		
LLEC CON	90545 0042	7-inch touch panel with integrated DALI-2 controller for monitoring up to 64 self-contained emergency luminaires. Required accessories: DALI bus power supply (no. 90545 0016) and 24 V power supply (no. 90545 0043)	
LLEC PS	90545 0043	24 V power supply for touch panel (no. 90545 0042)	
LLPO AKTOR 4X10	90545 0041	DALI-2 actuator with 4 volt-free outputs (max. 10 A). Suitable for signaling test states and system statuses of self-contained emergency luminaires	





Radio-based monitoring system for self-contained emergency luminaire

The radio-based LIMAS Air GUARD light management system uses the central monitoring unit and works with radio-capable self-contained emergency luminaires, recognisable by the abbreviation 'CS'. There are two variants of these self-contained emergency luminaires: MA-Z CS, which can be monitored via radio, and DIMD MA-Z CS, which can be both monitored and controlled via radio - all standard-compliant in accordance with DIN EN 50172 VDE 0108-100:2024-10.

The monitoring unit is configured and controlled via PC without additional software - a browser is all that is needed. The connection between the PC and the monitoring unit can be realised either via an existing network or by establishing a peer-to-peer connection. An Internet connection is not required. The lights themselves are conveniently set up using a free app for Android or iOS.

For further details and properties, see the chapter on light management systems.

System accessories

Type	Art.-No.		
LACA SENSBOX	10183 0002	External unit with integrated RFLS socket for connecting a radio module (can be combined with LIMAS Air CASA)	
RFL LACA FM DS	90546 9013	CASAMB® radio module with light sensor for RFL sockets	
LAGD CON	90545 0047	DALI-2 controller for monitoring up to 192 self contained emergency luminaires via radio on 3 DALI buses (additional system accessories and expert advice required)	



PROXIMA

Dustproof/Waterproof LED Emergency Light Fitting with Diffuser Series 161PX ..

Applications:

In humid, wet and dusty rooms as replacement lighting in the event of a power failure, or as safety lighting to illuminate escape and rescue routes.

Mechanical Design:

Housing: Glass fibre reinforced polyester resin, foamed silicone gasket.

Diffuser: Injected, acrylic glass, frosted, additional clear cover over the LED-modules to ensure protection against contact (Types ...MA).

Closure: Three-part plastic safety clips (KKS), unloseable.

Reflector: Aluminium, painted can be suspended or removed and carries the electrical components.

Connection: 3/4-pole terminal.

Cable entries: 3 plugs M20, loop in-out possible without further modification.

Mounting: 2 stainless steel retaining clips, 2 brackets for chain suspension, holes pre-pressed for direct fixing, sealing and pressure disks included in scope of deliver.

Technical Data:

LED: Linear modules 4,000 K, CRI > 80, service life L_{90} > 50,000 h at 25 °C ambient temperature, service life L_{80} > 70,000 h and L_{70} > 100,000 h at max. ambient temperature

Incorporated LiFePO4 battery, with temperature monitoring, short-circuit-proof connection, reverse polarity protection

Electronic deep discharge protection acc. to EN 61347-2-7

Re-charging time: 24 h, acc. to EN 60598-2-22

Automatic monitoring: of the emergency light fitting according to EN 62034, indication of the test results by 2-coloured LED (luminescence diode) at the luminaire

Mode of operation:

maintained operation = switching over to battery operation in case of mains failure, line modules will be operated with reduced luminous flux as emergency lighting.

Stand-by operation: Emergency light switches on in the event of a power failure.

Connection voltage: 220-240 V 50/60 Hz

Ambient temperature: 0 °C up to +40 °C

Options:

– 3,000 K, 5,000 K, 6,500 K; light colours (830, 850, 865)

– cable entry M25x1,5 mm²

– cover made of polycarbonate (PC), frosted

– stainless steel clips (KE)

– according to „International Featured Standard Food“ (IFS)

– according to „International Featured Standard Food“ (IFS) additionally with highly chemical-resistant cover (LM)

– dimming function via DALI-2 interface, compatible with LIMAS Line wired Light Management System (DIMD)

For self-contained emergency luminaire:

– through-wiring (DV), (see note)

4-conductor: L1, L1', N, PE or

6-conductor: L1, L1', L2', L3', N, PE

– DALI interface for centralised monitoring, compatible with LIMAS Line PRO or Line ESC wired Light Management Systems

– Radio module for centralised monitoring, compatible with LIMAS Air GUARD Light Management System

For a central power supply system:

– percentage reduction in luminous flux in DC operation (ZB15, ZB30, ZB50)

– for connection to a central power supply system with integrated monitoring module

– for connection to a central power supply system with integrated changeover switch

Wiring diagram maintained/stand by operation

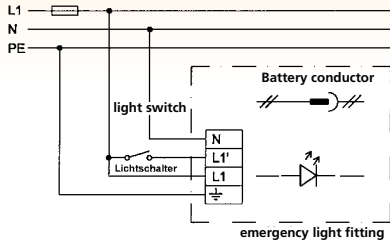

Installation: connect battery conductor

Decommission: disconnect battery conductor

Stand-by operation: do not connect L1'

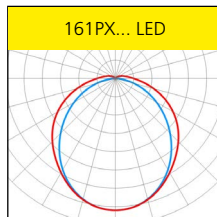
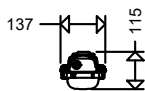
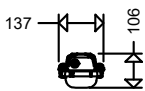
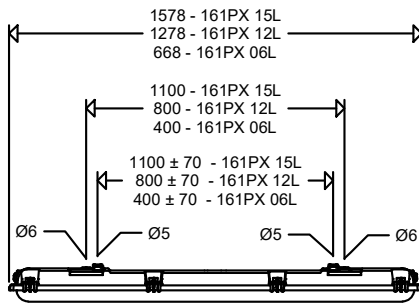

Standard cable entries for looping the mains cable on one side (loop in/loop out):

We deliver the light fittings with 2 cable entries on one small side. This feature allows an optimal adjustment to all local conditions and it will consequently save the typical quite expensive through wiring system. (Surcharge for 5-pole version).



Properties, limitations and details for controlling LED-light fittings:

■ See "Technical Supplement"

All data are correct at the time of printing. Actual technical data can be found under www.schuch.de.

Advantages of the emergency light version:

- always ready for operation (MA-versions) due to permanent trickle charging of the battery (>0°C)
- safety in an emergency, immediate light with maximum luminous flux, discharge also possible at low temperatures
- can be used up to +40 °C ambient temperature
- with ZB version 100 % luminous flux even in emergency operation
- reliable protection against contact due to additional clear cover (MA-versions)

General product highlights of the 161PX... series:

- high-impact resistant housing, wall thickness 1.8 mm
- diffuser with very high mechanical stability, wall thickness 2.0 mm
- safety clips to ensure protection against contact
- FastFix quick mounting system with retaining clips made of stainless steel
- flexible mounting with movable retaining clips
- front-side in/out wiring (3-pole) possible as standard due to 2 entries on one side
- variable cable entry possible through additional entries on the top of the enclosure at the front or in the centre, centring holes available
- sustainable, control gear and LED-module replaceable by qualified personnel on-site
- future proof by using standardised LED-modules (Zhaga) and long-term availability of spare parts

Article no.	Type	Connected load [W] (incl. battery charge)	Luminous flux [lm]	Luminous flux [lm] (emergency operation)	Luminous efficacy [lm/W]	Operating time 1 h	Operating time 3 h	Substitute for *	Weight [kg] (without packing material)
-------------	------	--	--------------------	---	--------------------------	--------------------	--------------------	------------------	---

161PX ../. MA



self-contained emergency luminaire with automatic monitoring

16140 0051	161PX 06L12/1 MA	12	1.410	600	118	•		1 x 18W	2,2
16140 0054	161PX 06L20/1 MA	18	2.330	600	129	•		2 x 18W	2,2
16140 0061	161PX 06L12/3 MA	12	1.410	600	118		•	1 x 18W	2,3
16140 0064	161PX 06L20/3 MA	18	2.330	600	129		•	2 x 18W	2,3
16140 0052	161PX 12L22/1 MA	17	2.440	600	144	•		1 x 36W	3,3
16140 0055	161PX 12L42/1 MA	29	4.300	600	148	•		2 x 36W	3,3
16140 0062	161PX 12L22/3 MA	17	2.440	600	144		•	1 x 36W	3,4
16140 0065	161PX 12L42/3 MA	29	4.300	600	148		•	2 x 36W	3,4
16140 0053	161PX 15L34/1 MA	23	3.520	600	153	•		1 x 58W	4,0
16140 0056	161PX 15L60/1 MA	41	6.270	600	153	•		2 x 58W	4,0
16140 0063	161PX 15L34/3 MA	23	3.520	600	153		•	1 x 58W	4,1
16140 0066	161PX 15L60/3 MA	41	6.270	600	153		•	2 x 58W	4,1

161PX .. ZB



for central power supply systems

Applications:

For connection to central power supply systems for illuminating escape routes.

Technical Data:

Light fitting with incorporated fuse for cut-off in case of failure according to DIN EN 60598-2-22, section 22.7.3.

Connection voltage: 220-240 V, 50/60 Hz and 220V DC

Ambient temperature: from -20 °C up to +40 °C

16140 0101	161PX 06L12 ZB	10	1.410	1.410	141			1 x 18W	1,7
16140 0104	161PX 06L20 ZB	16	2.330	2.330	146			2 x 18W	1,7
16140 0102	161PX 12L22 ZB	15	2.440	2.440	163			1 x 36W	2,8
16140 0105	161PX 12L42 ZB	27	4.300	4.300	159			2 x 36W	2,8
16140 0107	161PX 12L60 ZB	39	6.070	6.070	156			2 x 58W	2,8
16140 0103	161PX 15L34 ZB	21	3.520	3.520	168			1 x 58W	3,4
16140 0106	161PX 15L60 ZB	39	6.270	6.270	161			2 x 58W	3,4
16140 0108	161PX 15L75 ZB	49	7.590	7.590	155			> 2 x 58W	3,4

* The given information is for rough orientation only. In each individual case a lighting calculation is necessary.

Accessories and spare parts please see section „Dustproof/Waterproof LED Light Fitting with Diffuser Series 161PX... ” in our catalogue. When ordering electronic parts or battery sets please always mention the article no. of the respective fitting.

PROXIMA

Dustproof/Waterproof LED Emergency Light for high ambient temperatures up to +50 °C Fitting with Diffuser Series 161PX... H50

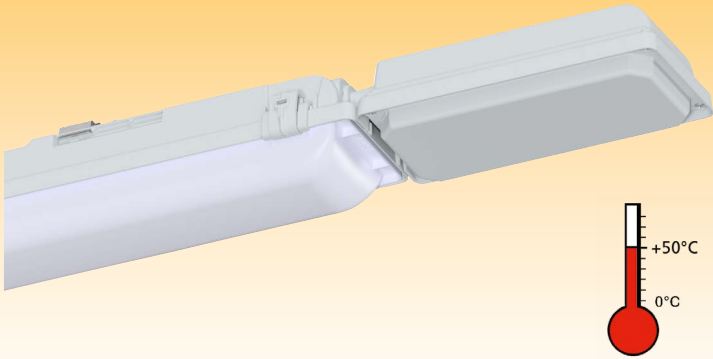

Wiring diagram maintained/stand by operation

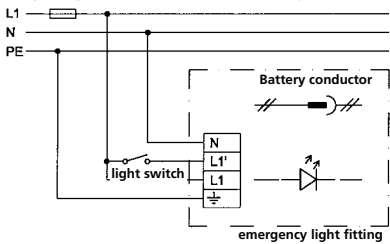

Installation: connect battery conductor
Decommission: disconnect battery conductor
Stand-by operation: do not connect L1'

161PX ... H (with battery box)

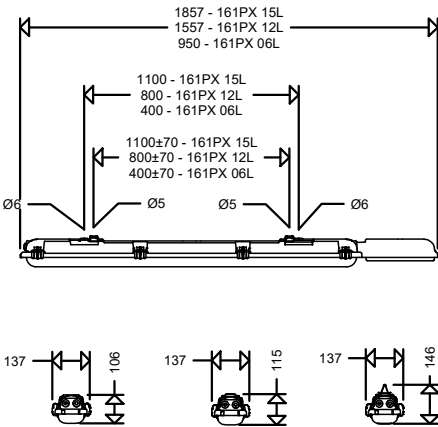

Standard cable entries for looping the mains cable on one side (loop in/loop out):

We deliver the light fittings with 2 cable entries on one small side. This feature allows an optimal adjustment to all local conditions and it will consequently save the typical quite expensive through wiring system. (Surcharge for 6-pole version).



Properties, limitations and details for controlling LED-light fittings:
 See "Technical Supplement"

All data are correct at the time of printing. Actual technical data can be found under www.schuch.de.

Applications:

In humid, wet and dusty rooms as replacement lighting in the event of a power failure, or as safety lighting to illuminate escape and rescue routes.

Mechanical Design:

Housing: Glass fibre reinforced polyester resin, with separate battery box at one small side of the housing, foamed silicone gasket.

Diffuser: Injected, acrylic glass, frosted, additional clear cover over the LED-module to ensure protection against contact.

Closure: Three-part plastic safety clips (KKS), unloseable.

Reflector: Aluminium, painted can be suspended or removed and carries the electrical components.

Connection: 4-pole terminal.

Cable entries: 2 plugs M20, loop in-out possible without further modification.

Mounting: 2 stainless steel retaining clips, 2 brackets for chain suspension, holes pre-pressed for direct fixing, sealing and pressure disks included in scope of deliver.

Technical Data:

LED: Linear modules 4,000 K, CRI > 80, service life $L_{90} > 50,000$ h at 25 °C ambient temperature, service life $L_{80} > 70,000$ h and $L_{70} > 100,000$ h at max. ambient temperature

Incorporated LiFePO4 battery, with temperature monitoring, short-circuit-proof connection, reverse polarity protection

Electronic deep discharge protection acc. to EN 61347-2-7

Re-charging time: 24 h, acc. to EN 60598-2-22

Automatic monitoring: of the emergency light fitting according to EN 62034, indication of the test results by 2-coloured LED (luminescence diode) at the luminaire

Mode of operation:

maintained operation = switching over to battery operation in case of mains failure, line modules will be operated with reduced luminous flux as emergency lighting.

Stand-by operation: Emergency light switches on in the event of a power failure.

Connection voltage: 220-240 V 50/60 Hz

Ambient temperature: 0 °C up to +50 °C

Options:

- 3,000 K, 5,000 K, 6,500 K; light colours (830, 850, 865)
- cable entry M25x1,5 mm²
- cover made of polycarbonate (PC), frosted
- stainless steel clips (KE)
- according to „International Featured Standard Food“ (IFS)
- according to „International Featured Standard Food“ (IFS) additionally with highly chemical-resistant cover (LM)
- dimming function via DALI-2 interface, compatible with LIMAS Line wired Light Management System (DIMD)
- DALI interface for centralised monitoring, compatible with LIMAS Line PRO or Line ESC wired Light Management Systems
- Radio module for centralised monitoring, compatible with LIMAS Air GUARD Light Management System

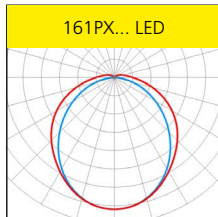

Advantages of the emergency light version:

- always ready for operation (MA-versions) due to permanent trickle charging of the battery (>0°C)
- safety in an emergency, immediate light with maximum luminous flux, discharge also possible at low temperatures
- can be used up to +50 °C ambient temperature
- reliable protection against contact due to additional clear cover (MA-versions)

General product highlights of the 161PX... series:

- high-impact resistant housing, wall thickness 1.8 mm
- diffuser with very high mechanical stability, wall thickness 2.0 mm
- safety clips to ensure protection against contact
- FastFix quick mounting system with retaining clips made of stainless steel
- flexible mounting with movable retaining clips
- front-side in/out wiring (3-pole) possible as standard due to 2 entries on one side
- variable cable entry possible through additional entries on the top of the enclosure at the front or in the centre, centring holes available
- homogeneous illumination by using frosted diffusers
- highest flexibility due to almost unlimited modification possibilities
- sustainable, control gear and LED-module replaceable by qualified personnel on-site
- future proof by using standardised LED-modules (Zhaga) and long-term availability of spare parts

Article no.	Type	Connected load [W] (incl. battery charge)	Luminous flux [lm]	Luminous flux [lm] (emergency operation)	Luminous efficacy [lm/W]	Operating time 1 h	Operating time 3 h	Substitute for *	Weight [kg] (without packing material)
-------------	------	--	--------------------	---	--------------------------	--------------------	--------------------	------------------	---

161PX ../. H50 MA



self-contained emergency luminaire with automatic monitoring for high temperatures up to +50 °C

Note:

For emergency light 161PX H with battery box please note:
Through-wiring not possible.

16144 0051	161PX 06L12/1 H50 MA	12	1.410	600	118	•		1 x 18W	3,0
16144 0054	161PX 06L20/1 H50 MA	18	2.330	600	129	•		2 x 18W	3,0
16144 0061	161PX 06L12/3 H50 MA	12	1.410	600	118		•	1 x 18W	3,1
16144 0064	161PX 06L20/3 H50 MA	18	2.330	600	129		•	2 x 18W	3,1
16144 0052	161PX 12L22/1 H50 MA	17	2.440	600	144	•		1 x 36W	4,1
16144 0055	161PX 12L42/1 H50 MA	29	4.300	600	148	•		2 x 36W	4,1
16144 0062	161PX 12L22/3 H50 MA	17	2.440	600	144		•	1 x 36W	4,2
16144 0065	161PX 12L42/3 H50 MA	29	4.300	600	148		•	2 x 36W	4,2
16144 0053	161PX 15L34/1 H50 MA	23	3.520	600	153	•		1 x 58W	4,8
16144 0056	161PX 15L60/1 H50 MA	41	6.270	600	153	•		2 x 58W	4,8
16144 0063	161PX 15L34/3 H50 MA	23	3.520	600	153		•	1 x 58W	4,9
16144 0066	161PX 15L60/3 H50 MA	41	6.270	600	153		•	2 x 58W	4,9

* The given information is for rough orientation only. In each individual case a lighting calculation is necessary.

Accessories and spare parts please see section „Dustproof/Waterproof LED Light Fitting with Diffuser Series 161PX... “ in our catalogue. When ordering electronic parts or battery sets please always mention the article no. of the respective fitting.



Dustproof/Waterproof LED Emergency Light Fitting with Diffuser Series 161 ..

Applications:

In humid, wet and dusty rooms as replacement lighting in the event of a power failure, or as safety lighting to illuminate escape and rescue routes.

Mechanical Design:

Housing: Glass fibre reinforced polyester resin, silicone gasket.

Diffuser: Injected, acrylic glass, frosted, additional clear cover over the LED-modules to ensure protection against contact (Types ...MA).

Closure: Three-part captive plastic clips (KK), incl. 2 safety clips (KKS)

Reflector: Aluminium, painted can be suspended or removed and carries the electrical components.

Connection: 3/4-pole terminal.

Cable entries: 2 plugs M20.

Mounting: Closed knock-outs for direct ceiling mounting (to be opened at site). Sealing and pressure disks inside each fitting.

Technical Data:

LED: Linear modules 4,000 K, CRI > 80, service life $L_{90} > 50,000$ h at 25 °C ambient temperature, service life $L_{80} > 70,000$ h and $L_{70} > 100,000$ h at max. ambient temperature

Incorporated LiFePO4 battery, with temperature monitoring, short-circuit-proof connection, reverse polarity protection

Electronic deep discharge protection acc. to EN 61347-2-7

Re-charging time: 24 h, acc. to EN 60598-2-22

Automatic monitoring: of the emergency light fitting according to EN 62034, indication of the test results by 2-coloured LED (luminescence diode) at the luminaire

Mode of operation:

maintained operation = switching over to battery operation in case of mains failure, line modules will be operated with reduced luminous flux as emergency lighting.

Stand-by operation: Emergency light switches on in the event of a power failure.

Connection voltage: 220-240 V 50/60 Hz

Ambient temperature: 0 °C up to +30 °C

Options:

– 3.000 K, 5.000 K, 6.500 K; light colours (830, 850, 865)

– cable looping at 1 small side

– cable entry M25x1,5 mm²

– cover made of polycarbonate (PC), frosted

– stainless steel clips (KE)

– according to „International Featured Standard Food“ (IFS)

– according to „International Featured Standard Food“ (IFS) additionally with highly chemical-resistant cover (LM)

– dimming function via DALI-2 interface, compatible with LIMAS Line wired Light Management System (DIMD)

For self-contained emergency luminaires:

Options:

– through-wiring (DV), (see note) 4-con-

ductor: L1, L1', N, PE or 6-conductor:

L1, L1', L2', L3', N, PE

– DALI interface for centralised monitoring, compatible with LIMAS Line PRO or Line ESC wired Light Management Systems

– Radio module for centralised monitoring, compatible with LIMAS Air GUARD Light Management System

For a central power supply system:

– percentage reduction in luminous flux in DC operation (ZB15, ZB30, ZB50)

– for connection to a central power supply system with integrated monitoring module

– for connection to a central power supply system with integrated changeover switch

Wiring diagram maintained/stand by operation

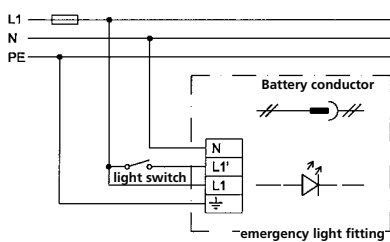

Installation: connect battery conductor

Decommission: disconnect battery conductor

Stand-by operation: do not connect L1'

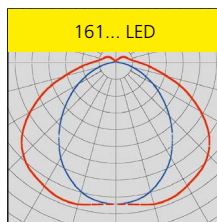
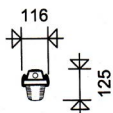
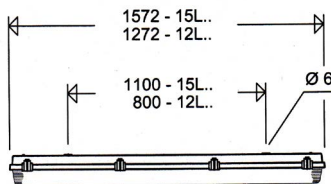

Advantages of the emergency light version:

- always ready for operation (MA-versions) due to permanent trickle charging of the battery (>0°C)
- safety in an emergency, immediate light with maximum luminous flux, discharge also possible at low temperatures
- 100 % luminous flux even in emergency mode (ZB-versions)
- reliable protection against contact due to additional clear cover (MA-versions)

General product highlights:

- robust, extremely strong quality light fitting especially suited for rough industrial use
- high-impact resistant housing, excellent chemical and UV-resistance
- diffuser with high mechanical stability, fourfold safety against outer impact
- safety locks to ensure protection against accidental contact
- front in/out wiring (3-pole) possible as standard thanks to 2 entries on one side
- homogeneous illumination by using frosted diffusers
- sustainable, control gear and LED-module replaceable by qualified personnel on-site
- future proof by using standardised LED-modules (Zhaga) and long-term availability of spare parts

Properties, limitations and details for controlling LED-light fittings:

See "Technical Supplement"

All data are correct at the time of printing. Actual technical data can be found under www.schuch.de.

Article no.	Type	Connected load [W] (incl. battery charge)	Luminous flux [lm]	Luminous flux [lm] (emergency operation)	Luminous efficacy [lm/W]	Operating time 1 h	Operating time 3 h	Substitute for *	Weight [kg] (without packing material)
-------------	------	--	--------------------	---	--------------------------	--------------------	--------------------	------------------	---

161 ../. MA



self-contained emergency luminaire with automatic monitoring

16118 0501	161 12L22/1 MA	17	2.390	620	141	•		1 x 36W	3,1
16118 0503	161 12L42/1 MA	29	4.240	620	146	•		2 x 36W	3,1
16118 0511	161 12L22/3 MA	17	2.390	620	141		•	1 x 36W	3,2
16118 0513	161 12L42/3 MA	29	4.240	620	146		•	2 x 36W	3,2
16118 0502	161 15L34/1 MA	23	3.440	620	150	•		1 x 58W	3,6
16118 0504	161 15L60/1 MA	41	6.160	620	150	•		2 x 58W	3,6
16118 0512	161 15L34/3 MA	23	3.440	620	150		•	1 x 58W	3,7
16118 0514	161 15L60/3 MA	41	6.160	620	150		•	2 x 58W	3,7

161 .. ZB



for central power supply systems

Applications:

For connection to central power supply systems for illuminating escape routes.

Technical Data:

Light fitting with incorporated fuse for cut-off in case of failure according to DIN EN 60598-2-22, section 22.7.3.

Connection voltage: 220-240 V, 50/60 Hz and 220V DC

Ambient temperature: from -20 °C to +40 °C (+30 °C for Types ... 12L60 and ... 15L75)

16118 0104	161 12L22 ZB	15	2.390	2.390	159			1 x 36W	2,6
16118 0049	161 12L42 ZB	27	4.240	4.240	157			2 x 36W	2,6
16118 0083	161 12L60 ZB	39	5.920	5.920	152			2 x 58W	2,6
16118 0103	161 15L34 ZB	21	3.440	3.440	164			1 x 58W	3,0
16118 0048	161 15L60 ZB	39	6.160	6.160	158			2 x 58W	3,0
16118 0063	161 15L75 ZB	49	7.440	7.440	152			> 2 x 58W	3,0

* The given information is for rough orientation only. In each individual case a lighting calculation is necessary.

Accessories and spare parts please see section „Dustproof/Waterproof LED Light Fitting with Diffuser Series **161/162.. LED**“ in our catalogue. When ordering electronic parts or battery sets please always mention the article no. of the respective fitting.

Dustproof/Waterproof LED Emergency Light Fitting with Diffuser Series 163... G2 / 163... G2 VARIO

Applications:

In humid, wet and dusty rooms as replacement lighting in the event of a power failure, or as safety lighting to illuminate escape and rescue routes.

Mechanical Design:

Housing: Glass fibre reinforced polyester resin, foamed gasket.

Diffuser: Acrylic glass for high mechanical strength, frosted, additional clear cover over the LED-modules to ensure protection against contact (Types ... MA).

Closure: Single-part plastic clips (KK), incl. 2 safety clips (KKS)

Reflector: Aluminium, painted, detachable carrying the electrical components.

Connection: 3/4-pole terminal.

Cable entries: 2 blanking plugs M20.

Cable entries open at the front. Variable cable entry pre-pressed on the long side and top side.

Mounting system: 2 holes for ceiling mounting. Sealing and pressure disks for sealing are supplied inside the fitting.

VARIO versions with variable setting of the luminous flux

Applications:

Factories in which, for reasons of maximum standardization and economic storage, only one type of damp-proof luminaire is to be used, which can be used for a wide variety of lighting tasks due to its variably adjustable luminous flux.

Design:

As standard version but with DIP switch for setting the luminous flux without tools. The luminaire luminous flux can be set to four values. Depending on the set luminous flux, the power consumption of the light fitting and the maximum permissible ambient temperature change.

Technical data:

LED: Linear modules 4,000 K, CRI > 80, service life L_{90} > 50,000 h at 25 °C ambient temperature, service life L_{80} > 70,000 h and L_{70} > 100,000 h at max. ambient temperature

Incorporated NiMH battery, electronic charger, short circuit protected battery and reverse battery protection

Electronic deep discharge protection acc. to EN 61347-2-7

Re-charging time: 24 h, acc. to EN 60598-2-22

Automatic monitoring the emergency light fitting according to EN 62034. Indication of the test results by 2-coloured LED (luminescence diode) at the luminaire.

Mode of operation:

maintained operation = switching over to battery operation in case of mains failure, line modules will be operated with reduced luminous flux as emergency lighting.

Connection voltage: 220-240 V 50/60 Hz

Ambient temperature: 0 °C up to +30 °C

Options:

– 3,000 K, 5,000 K, 6,500 K; light colours (830, 850, 865)

– cable looping at 1 small side

– cover made of polycarbonate (PC), frosted

– stainless steel clips (KE)

– according to „International Featured Standard Food“ (IFS)

– dimming function via DALI-2 interface, compatible with LIMAS Line wired Light Management System (DIMD)

For self-contained emergency luminaires:

– through-wiring (DV), (see note) 4-conductor: L1, L1', N, PE or 6-conductor: L1, L1', L2', L3', N, PE

– DALI interface for centralised monitoring, compatible with LIMAS Line PRO or Line ESC wired Light Management Systems

– Radio module for centralised monitoring, compatible with LIMAS Air GUARD Light Management System

For a central power supply system:

– percentage reduction in luminous flux in DC operation (ZB15, ZB30, ZB50)

– for connection to a central power supply system with integrated monitoring module

– for connection to a central power supply system with integrated changeover switch

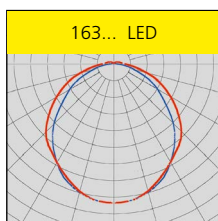

Wiring diagram maintained/stand by operation

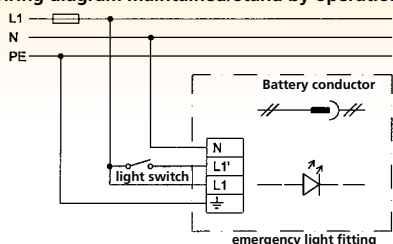

Installation: connect battery conductor
Decommission: disconnect battery conductor
Stand-by operation: do not connect L1'

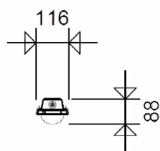
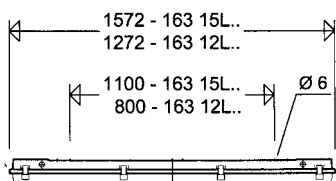

! Properties, limitations and details for controlling LED-light fittings:

■ See "Technical Supplement"

All data are correct at the time of printing. Actual technical data can be found under www.schuch.de.

Advantages of the emergency light version:

- always ready for operation due to permanent trickle charging of the battery (MA-versions)
- safety in an emergency, immediate light with maximum luminous flux, even at low temperatures (MA-versions)
- Central battery versions with 100 % luminous flux in case of emergency (ZB-versions)
- reliable protection against contact due to additional clear cover (MA-versions)

General product highlights:

- quality luminaire with above-average mechanical strength
- safety locks to ensure protection against accidental contact
- variable cable entry thanks to additional entries along and at the top of the housing
- homogeneous illumination by using frosted diffusers, comfortable perception of light and brilliant glare limitation
- sustainable, control gear and LED-module replaceable by qualified personnel on-site
- future proof by using standardised LED-modules (Zhaga) and long-term availability of spare parts

Article no.	Type	Connected load [W] (incl. battery charge)	Luminous flux [lm]	Luminous flux [lm] (emergency operation)	Luminous efficacy [lm/W]	Operating time 1 h	Operating time 3 h	Substitute for *	Weight [kg] (without packing material)
-------------	------	--	--------------------	---	-----------------------------	--------------------	--------------------	------------------	---

163 ..G2/. MA



self-contained emergency luminaire with automatic monitoring

16307 0031	163 12L22G2/1 MA	17	2.390	810	141	•		1 x 36W	2,6
16307 0033	163 12L42G2/1 MA	29	4.210	810	145	•		2 x 36W	2,6
16307 0052	163 15L34G2/1 MA	23	3.450	830	150	•		1 x 58W	3,0
16307 0054	163 15L60G2/1 MA	41	6.140	830	150	•		2 x 58W	3,0
16307 0055	163 15L34G2/3 MA	24	3.450	830	144		•	1 x 58W	3,4
16307 0056	163 15L60G2/3 MA	42	6.140	830	146		•	2 x 58W	3,4

NEW

163 ..G2 VARIO ZB



for central power supply systems

Applications:

For connection to central power supply systems for illuminating escape routes.

Technical Data:

Light fitting with incorporated fuse for cut-off in case of failure according to DIN EN 60598-2-22, section 22.7.3.

Connection voltage: 220-240 V, 50/60 Hz and 220V DC

Ambient temperature: from -20 °C to +40 °C

Product highlights of the VARIO version:

- universally usable due to variable setting of the luminous flux, depending on the requirement
- simple and quick adjustment on-site without tools
- can be changed at any time (e.g. change of use of the premises with new requirements in regard to the level of illumination)
- maximum standardisation and most economical warehousing

16307 0060	163 12LG2 VARIO ZB	20	3.100	3.100	155			1 x 36W	2,3
		25	3.870	3.870	155			1 x 58W	
		29	4.640	4.640	160			2 x 36W	
		34	5.420	5.420	159			2 x 58W	
16307 0061	163 15LG2 VARIO ZB	25	3.880	3.880	155			1 x 58W	2,8
		30	4.800	4.800	160			2 x 36W	
		36	5.760	5.760	160			2 x 58W	
		42	6.650	6.650	158			> 2 x 58W	

* The given information is for rough orientation only. In each individual case a lighting calculation is necessary.

Accessories and spare parts please see section „Dustproof/Waterproof LED Light Fitting with Diffuser Series **163... G2 VARIO / 164.. G2 LED** in our catalogue. When ordering electronic parts or battery sets please always mention the article no. of the respective fitting.

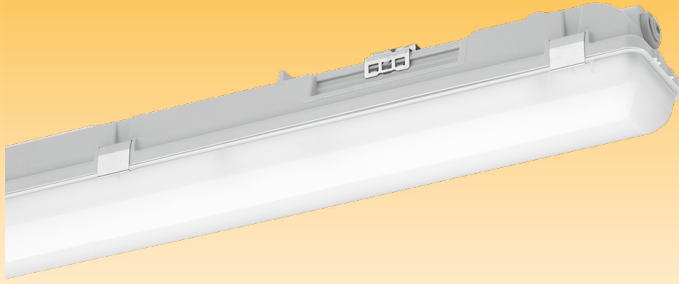

LUXANO 2

Dustproof/Waterproof LED Emergency Light Fitting with Diffuser Series 167 ... G2 / 167... G2 VARIO

Applications:

In humid, wet and dusty rooms as replacement lighting in the event of a power failure, or as safety lighting to illuminate escape and rescue routes.

Design:

Housing: Glass fibre reinforced polyester resin, foamed polyurethane gasket.

Diffuser: PMMA frosted for glare limitation, additional clear cover at the LED-modules to ensure contact protection against contact (Types ... MA).

Closures: stainless steel, in order to

ensure the contact protection. The light fitting can be opened with a tool only.

Reflector: Aluminium, painted, detachable carrying the electrical components.

Connection: 3/4-pole terminal.

Cable entries: 2 blanking plugs M20.

Cable entries open at the front. Variable cable entry pre-pressed on the long side and top side.

Mounting system: 2 reinforced retaining clips (also suitable for horizontal wall mounting), made of stainless steel, 2 brackets for chain suspension (included).

Wiring diagram maintained/stand by operation

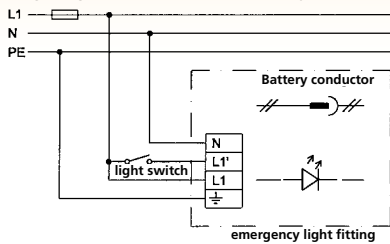

Installation: connect battery conductor
Decommission: disconnect battery conductor
Stand-by operation: do not connect L1'

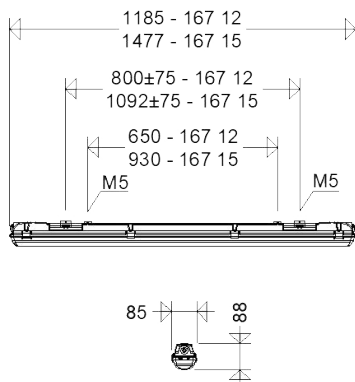

Technical data:

LED: Linear modules 4,000 K, $R_a > 80$, service life $L_{80} > 50,000$ h and $L_{70} > 100,000$ h at max. ambient temperature

Self contained NiMH battery, electronic charger, short circuit protected battery and reverse battery protection

Electronic deep discharge protection acc. to EN 61347-2-7

Re-charging time: 24 h, acc. to EN 60598-2-22

Automatic monitoring according to EN 62034. Indication of the test results by 2-coloured LED (luminescence diode) at the luminaire.

Mode of operation:

maintained operation = switching over to battery operation in case of mains failure, line modules will be operated with reduced luminous flux as emergency lighting.

Stand-by operation: Emergency light switches on in the event of a power failure.

Connection voltage: 220-240 V 50/60 Hz

Ambient temperature: 0 °C up to +30 °C

Options:

– 3.000 K, 5.000 K, 6,500 K; light colours (830, 850, 865)

– according to „International Featured Standard Food“ (IFS)

– dimming function via DALI-2 interface, compatible with LIMAS Line wired Light Management System (DIMD)

For self-contained emergency luminaire:

– through-wiring (DV), (see note) 4-conductor: L1, L1', N, PE or 6-conductor: L1, L1', L2', L3', N, PE

– DALI interface for centralised monitoring, compatible with LIMAS Line PRO

or Line ESC wired Light Management Systems

– Radio module for centralised monitoring, compatible with LIMAS Air GUARD Light Management System

For a central power supply system:

– percentage reduction in luminous flux in DC operation (ZB15, ZB30, ZB50)

– for connection to a central power supply system with integrated monitoring module

– for connection to a central power supply system with integrated changeover switch

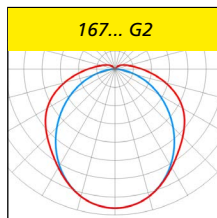

Advantages of the emergency light version:

- always ready for operation due to permanent trickle charging of the battery (MA-versions)
- safety in an emergency, immediate light with maximum luminous flux even at low temperatures (MA versions)
- 100 % light output even in emergency mode (ZB-versions)
- reliable protection against contact due to additional clear cover (MA-versions)

Product highlights of the VARIO version:

- universally usable due to variable setting of the luminous flux, depending on the requirement
- simple and quick adjustment on-site without tools
- can be changed at any time (e.g. change of use of the premises with new requirements in regard to the level of illumination)
- maximum standardisation and most economical warehousing

General product highlights of the LUXANO 2 series:

- quality luminaire with high-end components from renowned manufacturers
- stainless steel safety locks to ensure protection against accidental contact
- FastFix quick mounting system, with retaining clips made of stainless steel for variable mounting distances, without opening the fitting.
- variable cable entries, closed knock-outs on the short and long sides, and on the backside
- homogeneous illumination by using frosted diffusers, no individual light spots visible, comfortable perception of light and excellent glare limitation
- high flexibility thanks to a wide range of modifications
- sustainable, control gear and LED-module replaceable by qualified personnel on-site

Properties, limitations and details for controlling LED-light fittings:

See "Technical Supplement"

All data are correct at the time of printing. Actual technical data can be found under www.schuch.de.

Article no.	Type	Connected load [W] (incl. battery charge)	Luminous flux [lm] ¹⁾	Luminous flux [lm] (emergency operation)	Luminous efficacy [lm/W]	Operating time 1 h	Operating time 3 h	Substitute for *	Weight [kg] (without packingmaterial)
-------------	------	--	----------------------------------	---	-----------------------------	--------------------	--------------------	------------------	--

167 ..G2/. MA



self-contained emergency luminaire with automatic monitoring

16703 0022	167 12L42G2/1 MA	32	4.250	810	133	•		2 x 36W	2,2
16703 0021	167 15L34G2/1 MA	29	3.710	810	128	•		1 x 58W	2,5
16703 0023	167 15L60G2/1 MA	44	6.000	810	136	•		2 x 58W	2,7
16703 0024	167 15L34G2/3 MA	29	3.710	810	128		•	1 x 58W	2,8
16703 0025	167 15L60G2/3 MA	44	6.000	810	136		•	2 x 58W	2,8



167 ..G2 VARIO ZB

for central power supply systems - with variable adjustable luminous flux

Applications:

For connection to central power supply systems for illuminating escape routes.

Design:

As standard version 167... G2, but with DIP switch for setting the luminous flux without tools. The luminaire luminous flux can be set to four values. Depending on the set luminous flux, the power consumption of the light fitting and the maximum permissible ambient temperature change.

Mounting system: 2 reinforced retaining clips made of stainless steel, 2 bracket for chain suspension (included).

Technical Data:

Light fitting with incorporated fuse for cut-off in case of failure according to DIN EN 60598-2-22, section 22.7.3.

Connection voltage: 220-240 V, 50/60 Hz and 220V DC

Ambient temperature: from -20 °C to +35 °C

Notes:

In case of horizontal installation, the light fitting must be directly fixed with screws (washer and pressure disk are included) or it must be mounted with a reinforced retaining clips (see accessories)!

16703 0120	167 12LG2 VARIO ZB	18	2.700	2.700	150			> 1 x 36W	1,7
		21	3.100	3.100	148			< 1 x 58W	
		26	3.800	3.800	146			> 1 x 58W	
		30	4.300 ²⁾	4.300	143			2 x 36W	
16703 0121	167 15LG2 VARIO ZB	25	3.800	3.800	152			> 1 x 58W	1,9
		29	4.400	4.400	152			2 x 36W	
		36	5.400	5.400	150			< 2 x 58W	
		43	6.200 ²⁾	6.200	144			2 x 58W	

- 1) possible setting range
2) Factory setting

* The given information is for rough orientation only. In each individual case a lighting calculation is necessary.

Accessories / Spare Parts

Article no.	Type	
spare glasses, PMMA, frosted		
16711 9003	ABD 167 12 G2	cover, frosted PMMA diffuser, for 167 12 ... G2
16711 9004	ABD 167 15 G2	cover, frosted PMMA diffuser, for 167 15 ... G2
Fasteners		
90123 9008	167G2 KE V10	stainless steel (packing unit 10)
Cable entries		
90063 9000	2511	blanking plug M20
Accessories		
90049 0004	HK 167 G2 P	1 pair of retaining clips (stainless steel) reinforced for variable fastening

Compact LED Emergency/Escape Sign Light Fitting Series 164KL ...



Applications:

In humid, wet and dusty locations for illuminating and indicating any escape routes.

Design:

Housing: Glass fibre reinforced polyester, silicone gasket.

Diffuser: PMMA frosted for glare limitation, version ... L02 opalescent white (W).

Pictograms – if required – to be orde-

red separately, see accessories.

Clips: Single-piece plastic clips (KK).

Reflector: Painted aluminium, can be suspended or removed and carries the electrical component.

Connection terminal: 3 or 4 poles.

Cable entries: Variable, on the short sides and on the top, 2 plugs M20.

Mounting: 2 mounting points, rubber gasket and washers included.

Technical Data:

LED: Linear module 4,000 K or 6,500 K (Versions ... L02W), $R_a > 80$, service life $L_{90} > 50,000$ h at 25 °C ambient temperature, service life $L_{80} > 70,000$ h and $L_{70} > 100,000$ h at max. ambient temperature

Battery NiMH, a constant trickle charge to the battery ensures readiness of operation at all times.

Electronic deep discharge protection according to EN 61347-2-7

Charging period 24 h according EN 60598-2-22.

Automatic monitoring of the fitting according to EN 62034. Test results indicated by 2 colour LED.

Operating modes:

Maintained Mode: Switch over to battery back up in case of mains fail.

Version ... L08/ will operate at a reduced luminous flux.

Stand-by operation: Emergency light switches on in the event of a power failure.

Operating voltage: 220-240V; 50/60Hz

Ambient temperature: 0 to +30 °C in maintained mode
0 to +40 °C in stand-by mode

Options:

– 6,500 K; light colour (865)

– cable looping at 1 small side

– stainless steel clips (KE)

For self-contained emergency luminaire:

– DALI interface for centralised monitoring, compatible with LIMAS Line PRO or Line ESC wired Light Management

Systems

– Radio module for centralised monitoring, compatible with LIMAS Air GUARD Light Management System

For a central power supply system:

– for connection to a central power supply system with integrated monitoring module

Wiring diagram maintained/stand by operation

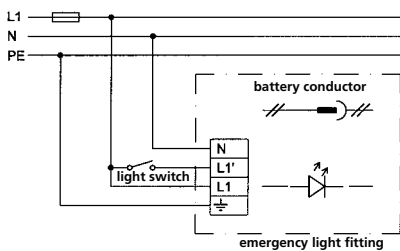

Installation: connect battery conductor
Decommission: disconnect battery conductor
Stand-by operation: do not connect L1'

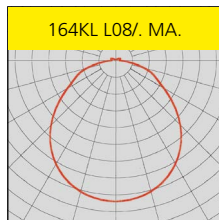
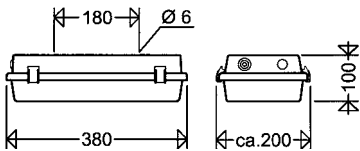

Advantages of the emergency light version:

- always ready for operation due to permanent trickle charging of the battery (MA-versions)
- safety in an emergency, immediate light with maximum luminous flux, even at low temperatures (MA-versions)
- Central battery versions with 100 % luminous flux in case of emergency (W MA - and ZB-versions)
- stable luminous flux in emergency mode, even at low temperatures
- excellent illumination of the pictogram. According to EN 1838 and DIN 4844

General product highlights:

- quality luminaire with above-average mechanical strength
- homogeneous illumination by using frosted diffusers, comfortable perception of light and brilliant glare limitation
- sustainable, control gear and LED-module replaceable by qualified personnel on-site
- future proof by using standardised LED-modules (Zhaga) and long-term availability of spare parts

Article no.	Type	Connected load [W] (incl. battery charge)	Luminous flux [lm]	Luminous flux [lm] (emergency operation)	Luminous efficacy [lm/W]	Light fitting for pictogram	Operating time 1 h	Operating time 3 h	Substitute for *	Weight [kg] (without packingmaterial)
-------------	------	---	--------------------	--	--------------------------	-----------------------------	--------------------	--------------------	------------------	---------------------------------------

164KL .../. MA



self-contained emergency luminaire with automatic monitoring

16408 0060	164KL L02/1 W MA	5	240	240	48	•	•	---	---	1,1
16408 0061	164KL L02/3 W MA	5	240	240	48	•	•	---	---	1,6
16408 0090	164KL L08G2/1 MA	7	680	590	97		•		1 x 11W	1,3
16408 0091	164KL L08G2/3 MA	8	680	590	85		•		1 x 11W	1,7

* The given information is for rough orientation only. In each individual case a lighting calculation is necessary.

Properties, limitations and details for controlling LED-light fittings:

See "Technical Supplement"

All data are correct at the time of printing. Actual technical data can be found under www.schuch.de.

Article no.	Type	Connected load [W] (incl. battery charge)	Luminous flux [lm]	Luminous flux [lm] (emergency operation)	Luminous efficacy [lm/W]	Light fitting for pictogram	Operating time 1 h	Operating time 3 h	Substitute for *	Weight [kg] (without packingmaterial)
-------------	------	--	--------------------	---	--------------------------	-----------------------------	--------------------	--------------------	------------------	--

164KL... ZB



for central power supply systems

For connection to central power supply systems for illuminating and indicating escape routes.

Technical Data:

Light fitting with incorporated fuse for cut-off in case of failure according to DIN EN 60598-2-22, section 22.7.3.

Connection voltage: 220-240 V, 50/60 Hz and 220V DC

Ambient temperature: -20 °C to +30 °C (+40°C for type ...L02 W)

16408 0045	164KL L02 W ZB	4	240	240	60	•			---	0,9
16408 0032	164KL L08G2 ZB	5	680	680	136				1 x 11W	1,0
16408 0034	164KL L15G2 ZB	10	1.350	1.350	135				1 x 24W	1,0

* The given information is for rough orientation only. In each individual case a lighting calculation is necessary.



Series 164KL... W with pictogram

Self-adhesive pictogram green/transparent



PIK 121/32



PIK 121/33



PIK 121/34



PIK 121/35



PIK 121/36



PIK 121/37



PIK 121/38



PIK 121/39

for light fittings with white opalescent glass windows for escape route signs acc. to DIN EN ISO 7010 und ASR A1.3.

Viewing distance = 30 m.



Accessories / Spare Parts

Article no.	Type	
Spare glasses		
16413 9001	ABD 164KL W	cover, PMMA diffuser white opalescent, for 164KL... W
16413 9007	ABD 164KL F G2	cover, frosted PMMA diffuser, for 164KL... G2
Brackets		
90232 0004	DA	ceiling bracket
Self-adhesive pictograms		
12112 0025	PIK 121/32	emergency exit up
12112 0026	PIK 121/33	emergency exit left
12112 0027	PIK 121/34	emergency exit right
12112 0028	PIK 121/35	emergency exit below
12112 0029	PIK 121/36	emergency exit up-left
12112 0030	PIK 121/37	emergency exit up-right
12112 0031	PIK 121/38	emergency exit down-left
12112 0032	PIK 121/39	emergency exit down-right

Further accessories and spare parts see section „Dustproof/Waterproof LED Light Fitting“ Series 164KL... in our catalogue. When ordering electronic parts or battery sets please always mention the article no. of the respective fitting.

Small Impact Resistant LED Emergency/Escape Sign Light Fitting Series 131... G2



Applications:

In humid, wet and dusty locations for illuminating and indicating the escape routes.

Design:

Housing: White polycarbonate.

Diffuser: Polycarbonate, ... L02 versions opalescent white (W). Hinged and detachable at one end and closed at the other end with captive stainless steel

screw. (Pictograms to be ordered separately see accessories)

Reflector: Aluminium white painted.

Connection: 3- or 4-poles.

Cable entries: 1 blanking plug M20 at each end.

Mounting system: 2 holes for ceiling mounting. Sealing and pressure disks inside each fitting.

Technical data:

LED: Linear module 4,000 K or 6,500 K (Versions ... L02W), $R_a > 80$, service life $L_{90} > 50,000$ h at 25 °C ambient temperature, service life $L_{80} > 70,000$ h and $L_{70} > 100,000$ h at max. ambient temperature

NiMH battery mounted on the reflector. A constant trickle charge to the battery ensures readiness of operation at all times.

Electronic deep discharge protection acc. to EN 61347-2-7

Recharging time: 24 h, acc. to EN 60598-2-22.

Automatic monitoring the emergency light fitting acc. to EN 62034. Indication of the test results by 2-colour LED on the light fitting.

Modes of operation:

Maintained operation: Switch over to battery operation in case of mains failure.

Stand-by operation: Emergency light switches on in the event of a power failure.

Connection voltage: 220-240 V, 50/60 Hz

Ambient temperatures: 0 °C up to +30 °C for maintained version
0 °C up to +40 °C for stand-by version

Wiring diagram maintained/stand by operation

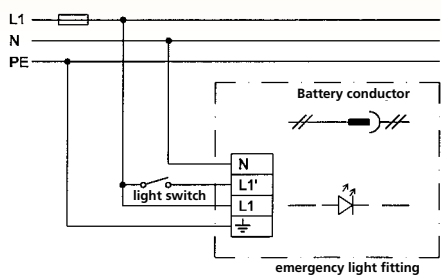

Installation: connect battery conductor

Decommission: disconnect battery conductor

Stand-by operation: do not connect L1'

Series 131... G2

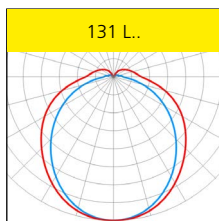
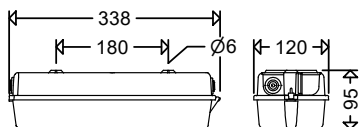

Options:

For self-contained emergency luminaire:

- DALI interface for centralised monitoring, compatible with LIMAS Line PRO or Line ESC wired Light Management Systems
- Radio module for centralised monitoring, compatible with LIMAS Air GUARD Light Management System

For a central power supply system:

- for connection to a central power supply system with integrated monitoring module

Advantages of the emergency light version:

- safety in an emergency, immediate full light (100 % luminous flux) even at low temperatures
- stable luminous flux in the emergency operation independent from the ambient temperature
- always ready for operation due to permanent trickle charging of the battery (MA-versions)
- outstanding even illumination of the pictogram, fulfills EN 1838 and DIN 4844
- reduced battery capacity (MA-versions)
- little thermal stress

General product highlights:

- robust, impact resistant compact light fitting entirely made from PC
- ideal for small spacing
- homogeneous illumination by using frosted diffusers comfortable perception of light
- high colour reproduction CRI > 80, according to the guide lines for workplaces suitable for nearly all plant locations
- best suitable in the food industry and in the food processing industry especially in risky areas falling under the IFS standards (International Featured Standard Food)
- sustainable, control gear and LED-module replaceable by qualified personnel on-site
- future proof by using standardised LED-modules (Zhaga) and long-term availability of spare parts

Properties, limitations and details for controlling LED-light fittings:

See "Technical Supplement"

All data are correct at the time of printing. Actual technical data can be found under www.schuch.de.



Article no.	Type	Connected load [W] (incl. battery charge)	Luminous flux [lm]	Luminous flux [lm] (emergency operation)	Luminous efficacy [lm/W]	Light fitting for pictogram	Operating time 1 h	Operating time 3 h	Substitute for *	Weight [kg] (without packing material)
-------------	------	--	--------------------	---	--------------------------	-----------------------------	--------------------	--------------------	------------------	---

131 ... G2 / . MA



13112 0130	131 L02G2/1 W MA	5	240	240	48	• •		---		1,0
13112 0131	131 L02G2/3 W MA	5	240	240	48	•	•	---		1,2
13112 0120	131 L03G2/1 MA	5	300	300	60		•	1 x 8W		1,0
13112 0121	131 L03G2/3 MA	5	300	300	60		•	1 x 8W		1,2

131 ... G2 ZB



for central power supply systems

For connection to central power supply systems for illuminating and indicating escape routes.

Technical data:

Light fitting with incorporated fuse for cut-off in case of failure according to DIN EN 60598-2-22, section 22.7.3.

Connection voltage: 220-240 V, 50/60 Hz and 220V DC

Ambient temperature: -20 °C to +30 °C (+40°C for type ...L02 W)

13112 0020	131 L02G2 W ZB	4	240	240	60	•		---		0,4
13112 0042	131 L07G2 ZB	5	650	650	130			1 x 11W		0,5
13112 0044	131 L13G2 ZB	10	1.300	1.300	130			2 x 11W		0,5

* The given information is for rough orientation only. In each individual case a lighting calculation is necessary.



Series 131... W LED with pictogram

Self-adhesive pictogram

for identification of escape routes according to DIN EN ISO 7010 und ASR A1.3.

Viewing = 15 m

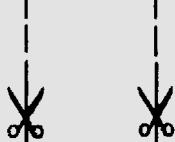

Accessories / Spare Parts

Article no.	Type	
Spare glasses		
13111 9001	ABD 131 W	cover, PC diffuser opalescent white for 131... W
13111 9008	ABD 131 W G2	cover, PC tray, white opal, for 131... G2 W
13111 9006	ABD 131 F	cover, frosted PC diffuser, for 131...
13111 9007	ABD 131 F G2	cover, frosted PC diffuser, for 131... G2
Pictogram, self-adhesive		
90011 0002	PIK 265/76/3	for 131... G2 W

Accessories and spare parts please see section „Dustproof/Waterproof LED Light Fitting with Diffuser Series 130/131 ... G2 LED“ in our catalogue. When ordering electronic parts or battery sets please always mention the article no. of the respective fitting.

Compact Emergency and Escape Sign Light Fitting with Highpower-LED Series 3611 ...



Applications:

Humid, wet and dusty locations in the trade, commerce and industry for emergency lighting as well as for illuminating and indicating any escape routes.

Design:

Housing: Die cast aluminium, white. All electrical components located inside the housing, wired ready for connection.

Cover: PC frosted, silicone gasket. As

indication sign light fitting with white opalescent PC glass (W) and pictogram. (Please order separately, see „Spare parts“).

Connection terminal: 3 or 4 poles.

Cable entry: 1 plug M20 on the front side.

Mounting: 2 outer fastening points.

Technical data:

LED: Linear module 4,000 K or 6.400K (Versions ... L02W), $R_a > 80$, service life $L_{90} > 50,000$ h at 25 °C ambient temperature, service life $L_{80} > 70,000$ h and $L_{70} > 100,000$ h at max. ambient temperature

Built-in NiMH battery: A constant trickle charge to the battery ensures readiness of operation at all times.

Electronic deep discharge protection acc. to EN 61347-2-7

Recharging time: 24 h, acc. to EN 60598-2-22.

Automatic monitoring of the emergency light fitting acc. to EN 62034. The test results are indicated by a two-colour LED on the fitting.

Modes of operation:

Stand-by operation: Emergency light switches on in case of mains failure

Maintained operation: Switching over to battery operation in case of mains failure

Voltage: 220-240 V, 50/60 Hz.

Ambient temperature: 0 °C up to +30 °C in stand-by operation

0 °C up to +40 °C in maintained operation

Options:

–cable looping at 1 small side

For self-contained emergency luminaire:

– DALI interface for centralised monitoring, compatible with LIMAS Line PRO or Line ESC wired Light Management Systems

For a central power supply system:

– for connection to a central power supply system with integrated monitoring module

Wiring diagram maintained/stand by operation

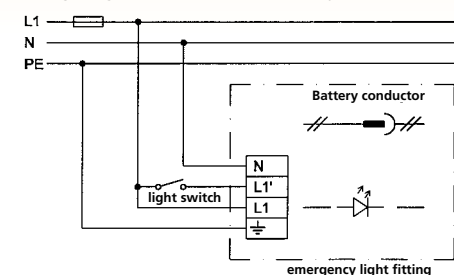

Installation: connect battery conductor
Decommission: disconnect battery conductor
Stand-by operation: do not connect L1'

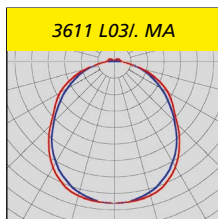
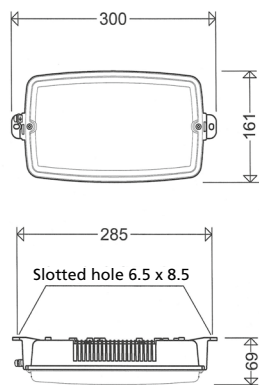

Advantages of the emergency light version:

- safety in an emergency, immediate full light (100 % luminous flux) even at low temperatures
- stable luminous flux in the emergency operation independent from the ambient temperature
- always ready for operation due to permanent trickle charging of the battery (MA-versions)
- outstanding even illumination of the pictogram, fullfills EN 1838 and DIN 4844

General product highlights:

- robust die-cast aluminium luminaire for rough environments
- ideal for small spacing
- homogeneous illumination by using frosted diffusers, comfortable perception of light
- best suitable in the food industry and in the food processing industry especially in risky areas falling under the IFS standards (International Featured Standard Food)
- quick mounting with outer fixing points
- sustainable, control gear and LED-module replaceable by qualified personnel on-site
- future proof by using standardised LED-modules (Zhaga) and long-term availability of spare parts

Article no.	Type	Connected load [W] (incl. battery charge)	Luminous flux [lm]	Luminous flux [lm] (emergency operation)	Luminous efficacy [lm/W]	Light fitting for pictogram	Operating time 1 h	Operating time 3 h	Weight [kg] (without packingmaterial)
-------------	------	---	--------------------	--	--------------------------	-----------------------------	--------------------	--------------------	---------------------------------------

3611 .../. MA



self-contained emergency luminaire with automatic monitoring

36111 0050	3611 L02/1 W MA	5,0	170	170	34	•	•		1,0
36111 0051	3611 L02/3 W MA	5,0	170	170	34	•		•	1,2
36111 0033	3611 L03/1 MA	5,0	290	290	58		•		1,0
36111 0034	3611 L03/3 MA	5,0	290	290	58			•	1,2

Properties, limitations and details for controlling LED-light fittings:

See "Technical Supplement"

All data are correct at the time of printing. Actual technical data can be found under www.schuch.de.

Article no.	Type	Connected load [W] (incl. battery charge)	Luminous flux [lm]	Luminous flux [lm] (emergency operation)	Luminous efficacy [lm/W]	Light fitting for pictogram	Operating time 1 h	Operating time 3 h	Weight [kg] (without packing material)
-------------	------	--	--------------------	---	--------------------------	-----------------------------	--------------------	--------------------	---

3611... ZB



for central power supply systems

For connection to central power supply systems for illuminating and indicating escape routes.

Technical data:

Light fitting with incorporated fuse for cut-off in case of failure according to DIN EN 60598-2-22, section 22.7.3.

Connection voltage: 220-240 V, 50/60 Hz and 220 V DC

Ambient temperature: -20 °C to +30 °C (+40°C for type ...L02 W)

36111 0030	3611 L02 W ZB	4,0	170	170	43	•			0,9
36111 0035	3611 L05 ZB	6,0	660	660	110				0,9
36111 0036	3611 L10 ZB	10,0	1.180	1.180	118				0,9



Type 3611 ... with pictogram

Self-adhesive pictogram
green / transparent



PIK 220/110/32



.../33



PIK 220/110/34



.../35

For light fittings with white opal glass.

For marking escape routes acc.to DIN EN ISO 7010 and ASR A1.3.

Viewing distance = 22 m

Accessories / Spare Parts

Article No.	Type	
spare diffusers		
36004 9003	ABD 3611 F	cover, frosted PC diffuser, for 3611...
36004 9002	ABD 3611 W	cover, PC diffuser, white opalescent, for 3611... W
Self adhesive legends		
12112 0100	PIK 220/110/32	Emergency exit upstairs
12112 0101	PIK 220/110/33	Emergency exit to the left
12112 0102	PIK 220/110/34	Emergency exit to the right
12112 0103	PIK 220/110/35	Emergency exit below

Accessories and spare parts please see section „Dustproof/Waterproof LED Light Fitting with Diffuser Series **3611 ... LED**” in our catalogue. When ordering electronic parts or battery sets please always mention the article no. of the respective fitting.

SCHUCH - Technical Supplement

Table of Contents

1. Explosion-Protected lighting	249-252		
1.1 Introduction	249		
1.2 Legal basis	249		
1.2.1 Directive 94/9/EC - 2014/34/EU	249		
1.2.2 EC Directive 99/92/EC	249		
1.3 Technical principles	249		
1.3.1 Equipment groups	249		
1.3.2 Zone classification (according to Directive 1999/92/EC)	249		
1.3.3 Equipment categories	250		
1.3.4 Temperature classes according to IEC 60079-0	250		
1.3.5 Group II	250		
1.3.6 Group III	250		
1.3.7 Classification of flammable gases, mists, vapours	250		
1.3.8 Combustible dusts	250		
1.3.9 Types of protection	251		
1.3.9.1 Flameproof enclosure „d“	251		
1.3.9.2 Increased safety „e“	251		
1.3.10 Marking	252		
1.4 Special operating conditions	252		
2. Marking	252		
3. General	253		
3.1 Permissible ambient temperatures	253		
3.2 Rated voltage	253		
3.3 EMC	253		
4. Properties of LED luminaires	253		
4.1 Rated values in the data sheets of LED luminaires	253		
4.2 Service life data of LED luminaires	253		
4.4 Use of LED luminaires in corrosive atmospheres	253		
4.5 Use of LED luminaires in humid atmospheres	253		
4.6 Mounting of LED outdoor luminaires of protection class II on mounting devices mounting devices that are electrically insulated from insulated from earth potential.	253		
4.7 Overvoltage protection for LED outdoor luminaires	253		
4.8 Restrictions in the operation of LED outdoor luminaires with power reduction	254		
4.9 Inrush currents with LED luminaires - limited automatic capacity	254		
4.10 Photobiological safety	254		
4.11 Replacement of control gear and LED modules during repair of luminaires.	254		
4.12 Light emissions (ULOR+ULR)	254		
5. Control of lighting systems, dimming and power reduction	254-256		
5.1 DIMA (analogue dimming)	254		
5.2 DIMD (Digital dimming and control with DALI)	254		
5.3 DIMC (Corridor function with control phase)	255		
5.4 LR (power reduction with control phase) for outdoor luminaires	255		
5.5 LA (self-sufficient power reduction without control phase) with outdoor luminaires	255		
5.6 CL (constant luminous flux function)	256		
5.7 MA-Z (central monitoring of self-contained luminaires via DALI line)	256		
5.8 DIMD MA-Z (central control and monitoring of self-contained luminaires with with DALI-2 ECG)	256		
5.9 DI (central monitoring of self-contained Ex luminaires via DALI line)	256		
5.10 DIMDI (central control and monitoring of self-contained Ex luminaires with DALI-2 ECG)	256		
5.11 RFL (luminaire with Zhaga Book 18 base(s), prepared for light control)	256		
5.12 Important information on the use of RFL luminaires with LIMAS Air CASA	256		
5.13 Other dimming functions	256		
5.14 Restrictions on the use of radar sensors	256		
5.15 Restrictions on the use of infrared sensors	256		
6. Safety classification for luminaires	257		
6.1 Degrees of protection to DIN VDE 0711/EN 60598/IEC 598	257		
6.2 Protection classes	257		
7. Areas of application and properties of SCHUCH luminaires	257-258		
7.1 Use of moisture-proof luminaires taking into account their degree of protection	257		
7.2 „F“ mark	257		
7.3 Luminaires with limited surface temperature „D“ symbol	257		
7.4 Frameless luminaires made of toughened safety glass	257		
7.5 Use of luminaires in animal husbandry	257		
7.6 PC cover glasses	258		
8. Emergency lighting	258-259		
8.1 Classification and terms	258		
8.2 Occupational safety	258		
8.3 Electrical engineering requirements	258		
8.4 Lighting requirements	258		
8.4.1 Safety lighting for escape routes	258		
8.4.2 Safety lighting for workplaces with particular hazards	258		
8.4.3 Safety signs and markings for escape routes	258		
8.5 Use of luminaires in emergency lighting systems with centralised emergency power supply systems (ZB)	259		
8.6 Monitoring LED lights in emergency lighting systems with centralised safety power supply systems	259		
8.7 Individual monitoring of self-powered LED luminaires	259		
8.8 Maintenance and testing of emergency lighting systems	259		
8.9 Conversion of general lighting luminaires to emergency luminaires	259		
9. Plastics in SCHUCH luminaires	259		
9.1 Chemical resistance	259		
10. Corrosion resistance of sheet steel luminaires	260		
11. Glare rating in industrial lighting	260		
12. Adaptive lighting	260		

The technical appendix provides information and notes that are important for the planning, installation and operation of lighting systems with SCHUCH Light Fittings.

1. Explosion-Protected lighting

1.1 Introduction

Luminaires may only be brought into areas with explosive atmospheres if they do not constitute a source of ignition for these explosive atmospheres. An explosion is defined as an oxidation or decomposition reaction that takes place at a high reaction rate and produces an increase in temperature or pressure or both at the same time. It involves reactions of flammable gases, mists and vapours or dusts and combustible flyings with the oxygen in the air.

Possible hazardous areas are, for example, in chemical factories, refineries, paint factories, paint shops, cleaning plants, mills and storage facilities for ground products, tank and loading facilities for flammable gases, liquids and solids.

1.2 Legal basis

Electrical installations and equipment in potentially explosive atmospheres are subject to special directives and regulations.

1.2.1 Directive 94/9/EC - 2014/34/EU

For the CENELEC (European Committee for Electrotechnical Standardization) area, Directive 94/9/EC (commonly referred to as ATEX 95, formerly ATEX 100a) of the European Parliament and Council of 23 March 1994 is of fundamental importance. ATEX means: Atmosphères Explosibles, i.e. explosive atmospheres.

The directive is primarily addressed to the manufacturers of explosion-protected equipment.

The harmonised standards of the EN 60079 ff series describe the different types of protection. Conformity with the requirements of the Directive is demonstrated for electrical equipment in categories 1 and 2 by the EU type examination certificate. For category 3 equipment, the manufacturer declares conformity with the requirements of the Directive on his own responsibility and issues an EU declaration of conformity or, for components, an attestation of conformity. The EU type examination certificate can be issued by a German authority, e.g. the Physikalisch Technische Bundesanstalt in Braunschweig (PTB, Notified Body No. 0102) as well as by another Notified Body.

On 29 March 2014, the new version of the ATEX Directive 2014/34/EU was published in the Official Journal of the European Union. The new directive has been in force since 20 April 2016. There are no fundamental improvements for manufacturers and designers. Mainly adaptations to the New Legislative Framework (NLF) are made. Old certificates according to Directive 94/9/EC remain valid.

1.2.2 EC Directive 1999/92/EC

EC Directive 1999/92/EC is generally known as ATEX 137 (formerly ATEX 118a) and is aimed primarily at the operators of installations with potentially explosive atmospheres. In Germany it was transposed into national law on 27 September 2002 as the „Ordinance on the Simplification of Legislation in the Field of Safety and Health Protection in the Provision of Work Equipment and its Use at Work, Safety in the Operation of Installations Requiring Monitoring and the Organisation of Occupational Health and Safety“ (Betriebssicherheitsverordnung - Betr.SichV, 27 Sept. 2002 BGBl, I p.2777).

1.3 Technical principles

An explosive atmosphere is a mixture of air and flammable gases, vapours, mists or dusts and combustible flyings under atmospheric conditions in which, after ignition has occurred, the combustion process is transferred to the entire unburned mixture. In a potentially explosive atmosphere, the atmosphere may become explosive due to local and operational conditions.

In EU Directive 2014/34/EU, electrical equipment for potentially explosive atmospheres is divided into groups, categories and temperature classes. This is necessary because the same requirements do not have to be placed on the equipment for every application and for every hazard level, which would also not make economic sense.

Electrical equipment for installations in potentially explosive atmospheres is generally designed for an ambient temperature range of -20 °C to +40 °C, unless an additional temperature specification extends or restricts this.

1.3.1 Equipment groups

A distinction is made between two equipment groups:

Equipment group I applies to equipment for use in underground operations of mines and their surface installations which may be endangered by firedamp and/or combustible dust.

Equipment group II applies to equipment for use in other areas which may be endangered by an explosive atmosphere.

1.3.2 Zone classification (according to Directive 1999/92/EC)

Potentially explosive atmospheres are classified into the following zones according to the likelihood of explosive atmospheres occurring:

Gases, vapours or mists

Zone 0 An area in which an explosive atmosphere is present either **continuously** or over **long periods** of time or **frequently** as a mixture of air and combustible gases, vapours or mists.

Zone 1 An area where under normal operating conditions an explosive atmosphere may **occasionally** be present as a mixture of air and combustible gases, vapours or mists.

Zone 2 An area where an explosive atmosphere is not likely to be present under normal operation but if it should occur for some reason it would normally only exist for a **short period** as a mixture of air and combustible gases, vapours or mists.

Dusts

Zone 20 An area in which an explosive atmosphere is present either **continuously** or over **long periods** or **frequently** as a cloud of combustible **dust** in the air.

Zone 21 An area where under normal operating conditions an explosive atmosphere may **occasionally** be present as a cloud of combustible dust in the air.

Zone 22 An area where an explosive atmosphere is not likely to be present under normal operation but if it should occur for some reason it would normally only exist for a **short period** as a cloud of combustible dust in the air.

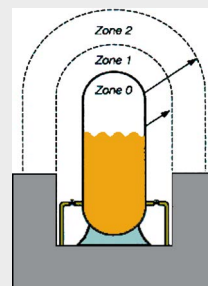

Illustration 1 and Illustration 2 show typical examples for the Zoning for flammable liquids

Illustration 1: Storage of flammable liquids

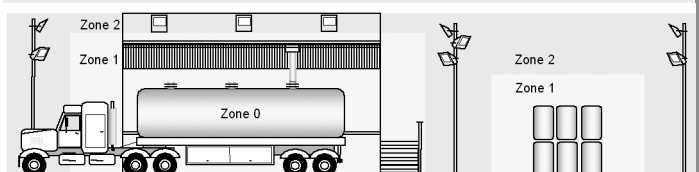

Illustration 2: Filling and storage of flammable liquids

1.3.3 Equipment categories

Acc. to the ATEX standards (2014/34/EU) the appliances for application in their relative zones are classified into categories. Similar to the different zones there are three different categories for group II equipment. Consequently, the explosion protected products can be allocated to the ex-zones existing in the production area.

Category 1 comprises appliances which have been designed in such a way that they may be operated in compliance with the characteristic parameters given by the manufacturer and which ensure a **very high level** of safety. **Appliances of this category** may be used in ZONES 0 and 20 as per their certification.

Category 2 comprises appliances which have been designed in such a way that they may be operated in compliance with the characteristic parameters given by the manufacturer and which ensure a **high level** of safety. **Appliances of this category** may be used in ZONES 1 and 21 as per their certification.

Category 3 comprises appliances which have been designed in such a way that they can be operated in compliance with the characteristic parameters given by the manufacturer and which ensure a **normal level** of safety. **Appliances of this category** may be used in ZONES 2 and 22.

Table 1 shows the relationship between zoning and equipment category.

Zone	Explosive Atmosphere	Category according to 2014/34/EU
Zone 0 Zone 20	continuously, long periods or frequently	Category 1
Zone 1 Zone 21	occasionally	Category 2
Zone 2 Zone 22	infrequently and short periods	Category 3

Table 1: Zoning - Equipment category

1.3.4 Temperature classes acc. to IEC 60079-0

An important parameter for the classification of gases is the ignition temperature. The ignition temperature is the lowest temperature value of a hot surface at which an explosive atmosphere ignites on it. This maximum surface temperature must always be lower than the ignition temperature of the gas, mist or vapour/air mixture in which it is used. Table 2 shows the temperature classes according to IEC 60079-0.

Temperature classification	Maximum permissible surface temperatures of equipment [°C]	Ignition temperatures of inflammable substances [°C]
T1	450	> 450
T2	300	> 300 ≤ 450
T3	200	> 200 ≤ 300
T4	135	> 135 ≤ 200
T5	100	> 100 ≤ 135
T6	85	> 85 ≤ 100

Table 2: Temperature classes

1.3.5 Group II

EN ISO/IEC 80079-20-1 „Material characteristics for gas and vapour classification“ describes a method for determining the maximum experimental safe gap MESH. The maximum gap width is of considerable importance for the type of protection flameproof enclosure „d“. Table 3 shows the maximum gap widths of group II for a volume of 20 ml according to EN ISO/IEC 80079-20-1, gap length 25 mm.

Group	Gap width MESH
IIA	> 0,9 mm
IIB	≥ 0,5 bis ≤ 0,9 mm
IIC	< 0,5 mm

Table 3: Group/maximum gap width (according to EN ISO/IEC 80079-20-1 with 25 mm gap length volume 20 ml)

1.3.6 Group III

Combustible solid particles in form of dust or flyings can explode in combination with air and an ignition source. The type of substance is decisive for the selection of equipment. Combustible solid particles are divided into subgroups according to their properties, see Table 4.

Group	
IIIA	combustible flyings
IIIB	non-conductive dusts: Specific electrical resistance > 1 kΩ m
IIC	conductive dusts: Specific electrical resistance ≤ 1 kΩ m

Table 4: Classification of flammable solid particles into sub-groups (according to the test method in EN ISO/IEC 80079-20-2)

1.3.7 Classification of flammable gases, mists, vapours

Table 5 shows the classification of gases, mists and vapours into groups and temperature classes.

Explosion group	Classification of gases and vapours into temperature classes					
	T1	T2	T3	T4	T5	T6
IIA	Acetone Ethane Ethyl acetate Ammonia Ethyl chloride Benzol Acetic acid Carbon monoxide Methanol Methyl chloride Naphthalene Phenol Propane Toluol	i-amy acetate n-butane n-butyl alcohol Cyclohexane 1,2-dichloroethane Acetic anhydride	Gasoline Diesel fuel Aviation fuel Heating oils n-hexane	Acetaldehyde	-	
IIB	Town gas	Ethylene Ethyl alcohol	Hydrogen sulphide	Ethyl ether	-	
IIC	Hydrogen	Acetylene			-	Carbon disphide
I	Methane					

temperature classes.

Table 5: Classification of flammable gases, mists and vapours

1.3.8 Combustible dusts

Similar to gases, mists and vapours, all combustible dusts and flyings (fibres that have become detached from fabrics or similar materials and are caught, for example, in the lint filter of a clothes dryer) can also react explosively under certain conditions. Possible ignition sources are electric sparks, hot surfaces, electrostatic charges etc. To exclude these ignition sources for the dust atmosphere, special types of ignition protection are used, such as „encapsulation“, „pressurised enclosure“ or „protection by enclosure“.

With the „protection by enclosure“ type of protection, dust and flyings are prevented from entering the luminaire by a dust-protected or dust-tight housing.

Dust or flyings can ignite on the outer surfaces of a luminaire. In this case, the surface temperature is the ignition source.

The highest occurring temperature of the luminaire surface with which combustible dust or flyings can come into contact must be noted as the maximum surface temperature on the type plate.

The properties of dust or flyings for explosion protection in luminaires are mainly described by two parameters, the **minimum ignition temperature of a dust cloud**

(MIT_C) and the **minimum ignition temperature of a dust layer (MIT_L)**. The **layer ignition temperature** is the temperature of a hot surface on which a layer of dust 5 mm thick begins to glow.

The **minimum ignition temperature** is the lowest temperature at which a dust cloud can ignite on brief contact with a heated wall.

If the minimum ignition temperature of the combustible dust that occurs is known, the maximum surface temperature of the luminaire can be used to decide on the particular application.

It is important to keep a safety margin between these two values. The lower of the two values is decisive.

The surface temperature of the equipment must be at least 75 K below the layer ignition temperature and must not be greater than 2/3 of the ignition temperature of the dust cloud. An example for hard coal:

$$MIT_C = 590 \text{ °C (minus } 1/3 \text{ MIT}_C = 394 \text{ °C).$$

$$MIT_L = 245 \text{ °C (minus } 75 \text{ K} = 170 \text{ °C)}$$

-> max. permissible surface temperature with a dust layer of max. 5 mm: 170 °C

Depending on the height of the dust accumulating on the luminaire, the maximum permissible surface temperature is reduced. A diagram for this can be found in the EN 60079-14 standard, where further information can also be found. For the example given above, this means that with coal dust and a layer thickness of 50 mm, the maximum surface temperature of the equipment must not exceed 80 °C, i.e. the layer ignition temperature is 80 °C with the appropriate safety margin.

A typical luminaire for areas susceptible to dust is shown in **Fig. 3**.

Fig. 3: Explosion-protected luminaire e865 for dust-hazardous areas of zone 21 in type of protection: protection by enclosure „t”.



1.3.9 Types of Protection

In areas where it is not possible to prevent the presence of a hazardous explosive atmosphere (primary explosion protection), only explosion-protected equipment may be used. The design measures required for this are described in the types of protection.

Luminaires are generally built with type of protection flameproof enclosure „d” or increased safety „e”.

EN 60079-7	- stands for: „Increased safety”	- code: „e”
EN 60079-1	- stands for: „Flameproof enclosure”	- code: „d”
EN 60079-5	- stands for: „Powder filling”	- code: „q”
EN 60079-2	- stands for: „Pressurised apparatus”	- code: „p”
EN 60079-11	- stands for: „Intrinsic safety”	- code: „i”
EN 60079-18	- stands for: „Encapsulation”	- code: „m”
EN 60079-31	- stands for: „Protection by enclosure”	- code: „t”
EN 60079-15	- stands for: „Zone 2”	- code: „n”
EN 60079-28	- stands for: „Limitation of optical radiation”	- code: „op is”

Analogous to the degree of protection of the equipment category (according to Directive 2014/34/EU) or the equipment protection levels EPL (according to IEC 60079-0), some types of protection are subdivided into levels of protection, e.g. the type of protection encapsulation in ma (use in Zone 0, 1, 2 or 20, 21, 22); mb (use in Zone 1, 2 or 21, 22) and mc (use in Zone 2 or 22), and the type of protection increased safety in eb (use in Zone 1, 2) and ec (use in Zone 2).

1.3.9.1 Flameproof enclosure „d”

The type of protection flameproof enclosure „d” is used for luminaires for use in Zone 1 mainly where ignition sources such as electric sparks and hot surfaces do not permit the use of the light source in luminaires of the type of protection increased safety. This is the case, for example, with LEDs.

The parts of an item of electrical equipment that can ignite a potentially explosive atmosphere are enclosed in a housing with this type of protection. The explosive mixture can penetrate the enclosure. In the event of an explosion of this mixture inside, the enclosure must withstand this pressure and prevent the transmission of the explosion to the explosive atmosphere surrounding the enclosure.

The fundamental difference to the type of protection increased safety „e” is that in the case of the type of protection „increased safety”, the occurrence of ignition sources that can trigger an explosion is prevented. With flameproof enclosure „d”, an explosion may occur inside the enclosure, but its transmission to the outside is prevented.

1.3.9.2 Increased safety „e”

The principle of this type of protection is to prevent sources of ignition from the equipment, i.e. measures are taken to prevent, with an increased level of safety, the possibility of e.g. impermissibly high temperatures and the occurrence of sparks or arcs inside or on external parts of electrical equipment. The type of protection is applicable to electrical equipment and parts thereof which do not produce sparks or assume dangerous temperatures under normal operating conditions. The type of protection increased safety „e” has become established worldwide for luminaires for fluorescent lamps, especially for economic reasons for use in Zone 1. LEDs must have an additional type of protection in order to be installed in luminaires for use in Zone 1, e.g. encapsulation.

Figs. 4 and 5 show special luminaires with type of protection increased safety „e”.



Fig. 4: Explosion-protected high-bay luminaire e8825 with type of protection: increased safety „e”



Figure 5: Explosion-protected floodlight e8820 in the type of protection: increased safety „e”

Fig. 6 and **Fig. 7** show two typical luminaires with type of protection increased safety „e”. The advantage over luminaires in flameproof enclosure „d” is the considerably lower weight and the simplified replacement of electronic components and easier maintenance. In terms of price, this luminaire also has advantages over the luminaire in flameproof enclosure „d”.



Fig. 6: Explosion-protected polyester diffuser luminaire e865 in type of protection increased safety „e”



Fig. 7: Explosion-protected steep roof luminaire e821 in the type of protection increased safety „e”

Figure 6 shows an Ex-protected LED diffuser luminaire for use in Zone 1 and Zone 21. The LED modules are manufactured with a special encapsulation. The following characteristic data apply:

Type of protection: eb

Explosion protection:

II 2 G Ex eb mb q IIC T4 Gb (Zone 1)

II 2 D Ex tb IIIC T80°C Db (Zone 21)

1.3.10 Marking

Fig. 8 shows the type plate of an explosion-protected LED luminaire in the type of protection increased safety „e” in which other types of protection also apply, in this case encapsulation „m” for the LED module and powder filling „q” in which the electronic ballast is designed and encapsulated.

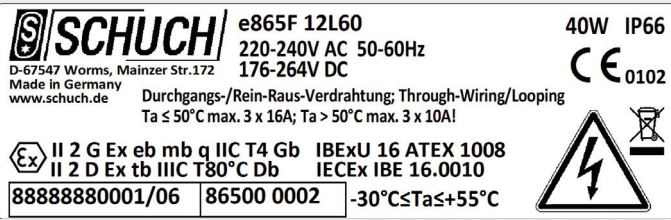
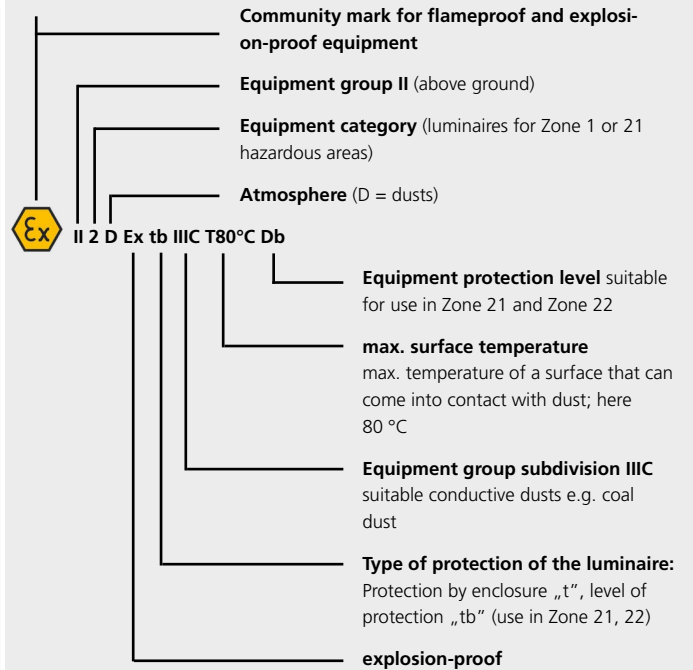
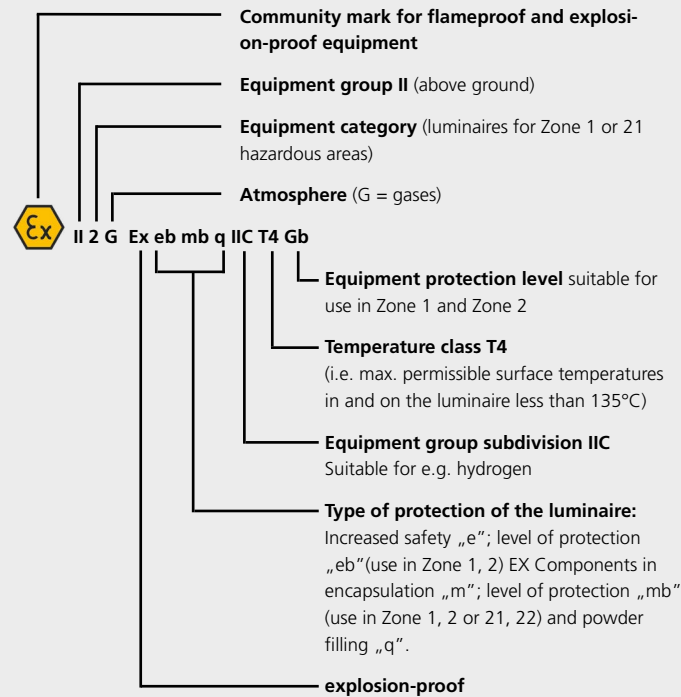

Figure 8: Example of marking of an explosion-protected luminaire



In addition, the following information is required:

$-30\text{ °C} \leq T_a \leq +55\text{ °C}$ permissible operating temperature range if different from -20 °C bis $+40\text{ °C}$

IBExU Notified body (Institute for Safety Engineering)

CE 0102 CE -marking with the number of the Notified Body that monitors the QM system (0102 = Physikalisch Technische Bundesanstalt, PTB).

1.4 Special operating conditions

If the luminaire is subject to special operating conditions, such as chemical, mechanical, thermal, electrical, vibration, humidity, etc., this must be discussed in advance between the operator and the manufacturer so that additional measures can be taken if necessary. This is pointed out both by Directive 1999/92/EC and by the standard DIN EN 60079-14 or VDE 0165, which is authoritative for the operator of electrical equipment in potentially explosive atmospheres.

Ex luminaires usually have a high IP degree of protection, expressed e.g. by the marking „IP66”. However, this does not mean that the luminaire is hermetically sealed.

Luminaires are classified and tested in different degrees of protection according to the European standard EN 60529. This standard contains the German translation of the international standard IEC 60529 and is also a VDE regulation, as it has been approved by the VDE and classified under VDE 0470, Part 1.

In the current edition of this standard, a brief description and definition for the degrees of protection represented by the second code number is given in section 6.

For example, the short description for the second code number 6 is: „Protected against strong jets of water.” The definition given is: „Water splashing against the enclosure from any direction as a strong jet shall have no harmful effects.”

In this standard, the humidity of the air is not taken into account as a relevant criterion when classifying the degrees of protection.

Damp and cold ambient conditions combined with low duty cycles can restrict the use of luminaires with electronic ballasts.

Before installing luminaires, e.g. in rainwater retention basins, in water treatment plants or above clarification basins, etc., the manufacturer should be consulted in order to use special designs if necessary.

2. Marking

All SCHUCH luminaires bear the CE-marking. The CE-marking documents that the product complies with the relevant EU directives and may be freely marketed on the EU domestic market.

Whether a luminaire has test marks or other optional markings can also be found in the product data sheet.

3. General information

3.1 Permissible ambient temperatures

If no additional information is given, **LED luminaires** are designed for a maximum permissible ambient temperature of **-20 °C to +25 °C**.

Emergency luminaires are excluded from this.

Explosion-protected equipment is generally designed for an ambient temperature of up to **+40 °C**.

Special versions for lower (**T..**) or higher (**H..**) temperatures are available on request.

3.2 Rated voltage

Unless otherwise indicated, all luminaires listed in the catalogue are suitable for a rated voltage of 230 V ± 10 % / 50 Hz. Luminaires for other voltages and frequencies are usually available on request.

3.3 EMC

The EMC Directive and the Electromagnetic Compatibility Act (EMVG) regulate the requirements for EMC and ensure that only luminaires with a sufficient level of electromagnetic compatibility are placed on the European market; EMC is therefore a product characteristic and thus a quality feature. The corresponding technical requirements as a basis for EMC are defined in the European standards. In Germany, the Bundesnetzagentur is responsible for and monitors EMC.

EMC conformity means that every luminaire complies with the protection requirements; these are:

- limited interference emission (EN IEC 55015)
- adequate immunity to interference (EN IEC 61547)
- limitation of mains harmonics (EN IEC 61000-3-2)
- limitation of voltage changes/fluctuations and flicker (EN IEC 61000-3-3)

Compliance with the standards ensures a defined compatibility of different loads. Nevertheless, even if the standards are complied with, unfavourable distances between useful and interference levels may impair e.g. radio reception when using a radio with a rod antenna. In this case, the distance between the radio and the luminaire must be increased, for example.

4. Properties of LED luminaires

4.1 Rated values in the data sheets of LED luminaires

All tolerances of the rated values for system wattage, luminaire luminous flux and luminous efficacy stated in the catalogue comply with the specifications according to IEC 62722-2-1. The luminaire luminous flux is not more than 10 % below the stated rated luminous flux. The connected load of the luminaire is not more than 10 % above the rated power specified in the data sheet. All rated values refer to an ambient temperature of $T_a = 25\text{ °C}$ unless otherwise stated. If LED luminaires are operated at higher temperatures, the luminaire luminous flux is typically reduced by 1.5 % per 10 K.

4.2 Service life specifications of LED luminaires:

The data sheet specifies the average rated service life L_x . L_x describes the time after the original luminaire luminous flux has decreased to a percentage value x . At the rated service life L_x , the luminaire luminous flux is $x\%$ of the initial value. Typical values of „ x “ are 70 (L_{70}), or 80 (L_{80}). The specification of the rated service life is linked to the proportion of luminaires with increased luminous flux reduction B_y and is represented as $L_{x,y}$. The value B_{50} thus means that 50 percent of the luminaires fall short of the declared luminous flux component „ x “ at the end of the average rated service life L_x and 50 percent exceed it. **The service life specifications are based on defined test procedures. The specifications in the data sheet are expected values. The specified service life is therefore not a guaranteed property of the luminaire.** The specification $L_{80,B_{10}} \geq 50,000\text{h}$ means that statistically 90 % (100-10) of all luminaires still have at least 80 % of their original luminous flux after 50,000 h. $B_y = B_{50}$ applies to the average rated service life L_x (without addition). According to a recommendation of the ZVEI, this value should be stated in the data sheets.

Failures of control gear as well as the degree of soiling of the luminaire are not taken into account here.

The failure rate of operating devices depends not only on the specification of the components and their quality, but also to a large extent on the operating temperature. The following applies: for t_c max. (maximum permissible device temperature)

the failure rate is 2 % per 1,000 h, i.e. for a service life of 50,000 h the percentage of failed units is up to 10 %.

Example: With 100 ECGs in continuous operation (at the max. permissible t_c temperature), statistically up to 10 units will have failed after 5.7 years.

Operation at lower ambient temperatures reduces failure rate.

4.4 Use of LED luminaires in corrosive atmospheres

Harmful gases and other corrosive substances (e.g. ammonia, sulphur or chlorine compounds) can damage LEDs. Depending on the substance, concentration, temperature and duration of exposure, damage or even total failure is possible.

Even luminaires with a high ingress protection are affected by this. Corrosive atmospheres can penetrate the luminaires. A high IP code does not automatically mean that a luminaire is gas-tight. The suitability of the luminaires for the respective application can be determined e.g. by a practical test on site.

We recommend the use of luminaires from our luminaire range that are specially designed for use in areas exposed to hazardous gases.

- **ER version:** Increased protection against corrosive atmospheres. Luminaires in ER version are approved e.g. for use in production facilities and warehouses for vehicle tyres.
- **Version HR:** High protection against corrosive atmospheres. Luminaires in version AUS HR are approved e.g. for use in outdoor areas of sewage treatment plants.
- **Version XR:** Absolutely gas-tight luminaire. The Primo XR luminaire is approved for hazardous gas areas (exception: explosive atmospheres, swimming pools, exposure to chemicals that attack PMMA or stainless steel).

4.5 Use of LED luminaires in a humid atmosphere

If luminaires are operated in cold, damp conditions with a low switch-on time, there is a risk of premature failure. This also affects luminaires with a higher protection class. This problem can be remedied by switching the luminaire on regularly and for longer periods. In many applications, this is not possible or desirable: rainwater retention basins, corridors in lock systems/dams, drinking water facilities, and agricultural applications (potato storage, wine cellars). The LUXANO 2 series luminaires in HL (high humidity) design are available specifically for these cases. These luminaires are equipped with components that are specially protected against moisture. Regular operation is not necessary. Other suitable special designs are available on request.

4.6 Mounting of LED outdoor luminaires of protection class II on mounting devices that are electrically insulated from the earth potential.

When mounting LED luminaires of protection class II on fixing devices that are electrically insulated from the earth potential, electrostatic charges may occur due to weather conditions, among other things. This can cause damage to the control gear and/or the LED modules.

Mounting devices insulated from the earth potential are, for example, wooden, concrete or plastic poles, insulated steel poles, wall mountings and cable suspensions.

The installation of a luminaire in protection class I is a remedy. In this case, charges are discharged via the PE.

If protection class II luminaires are to be installed, a special version with ESD discharge is available.

4.7 Overvoltage protection for LED outdoor luminaires

LED outdoor luminaires are significantly more sensitive to overvoltage events than luminaires with conventional ballasts.

Switching operations/load changes can cause overvoltages of up to approx. 6 kV in the mains.

Lightning strikes in the vicinity of outdoor lighting installations can cause voltages up to a multiple of 10 kV, depending on the distance of the strikes to the luminaire and the conductivity in the ground.

In the case of direct lightning strikes in a streetlight, the pulse heights that occur are so great that there is no economically justifiable protective measure.

The ECGs used by SCHUCH already have an increased surge voltage resistance.

The surge voltage resistance of the luminaire can be further increased by an additional surge protection module in the luminaire or in the cable junction box.

Surge protection modules, which disconnect the luminaire from the mains in the event of their own defect, offer even greater operational safety.

Increased overvoltage protection in protection class II luminaires is only possible to a limited extent for normative reasons, among others!

No protective earth conductor may be connected in protection class II luminaires. However, comprehensive overvoltage protection is only possible if the protective earth conductor is available and the luminaire housing and mast are connected to the protective earth conductor.

As a further measure, we recommend installing surge arresters in the distribution boards. This will intercept direct and indirect lightning strikes into the supply network.

The probability of a lightning strike varies greatly from region to region and in Central Europe varies from less than one strike per year and km² to over 20 strikes per year and km².

Should outdoor LED luminaires or outdoor luminaires with electronic ballasts be installed e.g. in areas with an increased probability of lightning strikes, we recommend the use of luminaires of protection class I and an additional surge protection module in the cable junction box, or in the luminaire (on request) as well as measures in the distribution board.

4.8 Restrictions in the operation of LED outdoor luminaires with power reduction

In extremely rare cases, leakage currents may occur between the phases or phase and neutral. This can lead to incorrect switching behaviour in luminaires with power reduction. The luminaires then do not switch to power reduction.

Leakage currents can be caused by old, damaged cables with insufficient insulation or high capacitive coupling.

When replacing individual luminaires in existing installations with older LED luminaires or when extending lighting installations, problems can also occur when switching to power reduction. In such cases, additional relays must be retrofitted at the control phase input in the luminaires already installed. In such cases, it is more cost-effective to add luminaires with autonomous power reduction (LA => without control phase).

4.9 Inrush currents with LED luminaires - limited automatic load capacity

In contrast to luminaires with conventional control gear, in lighting systems with LED luminaires all luminaires start at the same time (also applies to ECG luminaires with conventional lamps).

In the storage capacitor of these ECGs, a very high charging current flows for a short time at the moment of switch-on. The maximum permissible number of luminaires per miniature circuit-breaker is not limited by the operating current but by the inrush current. It can be found online on the respective product data sheet of the luminaire.

4.10 Photobiological safety

The photobiological safety of luminaires is dealt with in the DIN EN 62471:2009 standard. It describes limit values or risk groups for irradiation as well as corresponding measurement methods in the UV, visible and infrared spectral range. The protection goal is to exclude thermal as well as photochemical hazards to the human eye and skin.

Almost all SCHUCH luminaires fall into the lower risk groups 0 and 1. They cannot cause any photobiological damage to the eye or human skin and are therefore harmless. Luminaires that fall into risk group 2 are marked with a picture symbol („do not look into the light source“). In addition, the installation instructions indicate the distance at which looking into the luminaire is safe. Due to the installation location, a hazard can be ruled out for most technical luminaires of risk group 2, as it is not possible to look into the luminaire from a short distance. Doubling the distance reduces the radiation reaching the eye to a quarter (square law of distance). Therefore, in most cases, caution is only required during maintenance work.

Luminaires in risk group 3 cannot be approved because they would pose a not inconsiderable risk.

4.11 Replacement of control gear and LED modules when repairing luminaires.

SCHUCH LED luminaires contain „light sources that cannot be replaced by the user“, so-called LED modules. These LED modules may only be replaced by SCHUCH, a service technician appointed by SCHUCH or a similarly qualified person. (* not an electrotechnical specialist).

The replacement of electrical components or the repair of LED luminaires may only be carried out with components supplied or authorised by SCHUCH.

Many control gear units have programming, i.e. replacing a control gear unit with an

identical unit does not automatically guarantee the desired function!

When repairing LED luminaires, there is a risk that LEDs may be damaged or even directly destroyed by electrostatic discharges. ESD protective measures must therefore be taken when repairing the luminaires (dissipative work surface, ESD shoes/ESD wristband, ESD clothing).

In protection class II luminaires with metal housings, cables with double insulation are installed for safety reasons and cables are fixed to each other with cable ties at terminal points. When repair work is carried out, the original condition of the luminaire must be restored, e.g. double-insulated cables must not be replaced by single-insulated cables. Cable ties that have been removed must be replaced.

4.12 Light emissions (ULOR+ULR)

ULOR (Upward Light Output Ratio): Indicates the proportion of the luminous flux emitted by a horizontally aligned luminaire (inclination 0°) into the upper half-space. The value is usually given as an integer percentage.

ULR (Upward Light Ratio): In contrast to ULOR, which refers exclusively to the luminaire, ULR indicates the proportion of luminous flux emitted into the upper half-space by a luminaire mounted in an installation. This is therefore largely dependent on the inclination of the luminaire. The value is usually given as an integer percentage.

5 Control of lighting systems, dimming and power reduction

5.1 DIMA (Analogue Dimming)

By means of an external potentiometer or a control voltage of 1-10V, dimming in the range of typically 10-100 % is possible (LED). Several luminaires can be operated in parallel on one 1-10 V line, the max. number depends on the load capacity of the potentiometer/control unit and the line length. The number of ECGs to be connected can be increased with a signal amplifier. Due to voltage drop on the line and coupling of interference, luminaires on a line may nevertheless have slightly different dimming levels.

All luminaires with DIMA feature are supplied with 2 additional terminals, marked „1-10 V+“ and „1-10 V-“. The cables to the control inputs must be of mains voltage-proof design and can be included in the connection cable.

5.2 DIMD (Digital Dimming and Control with DALI)

DALI (Digital Addressable Lighting Interface) and the further developed standard DALI-2 are a protocol for controlling luminaires. With a small number of lines, many luminaires can be controlled individually even over long distances. In addition, DALI can be easily integrated into higher-level building automation systems such as KNX, EIB or LON.

DALI-2 is the latest version of DALI, which ensures improved interoperability between components from different suppliers through mandatory certification and extended functions, e.g. energy data.

Up to 64 operating devices can be controlled via one DALI line. It should be noted that several control gear units can be installed in one luminaire. The maximum cable length is 300 m with a minimum cable cross-section of 1.5 mm². The range may be limited due to unfavourable conditions. A larger range can only be achieved with repeaters, a higher number of luminaires per DALI line only with broadcast commands. (Attention, this severely limits the functionality of a DALI-2 system in particular). Better is the parallel operation of several DALI lines with one controller. With LIMAS Line PRO SCE controllers, 3 DALI lines can be operated. By networking (LAN) several controllers, up to 15 DALI lines are possible (960 control gear units).

Dimming levels of 1-100 % are possible depending on the control gear. For the operation of a DALI system, further devices are required (controller, power supply unit, etc.), which are not included in the scope of delivery of the luminaire.

All luminaires with DIMD feature are delivered with 2 additional terminal points, marked „DA“. The polarity is irrelevant. The cables to the control inputs must be of mains voltage-proof design and can be included in the connection cable.

DALI inputs have only a low overvoltage resistance. Networking with DALI is therefore not recommended for outdoor luminaires. The lines should be routed from the luminaire to the cable transition box at the most, e.g. for connecting Powerline or a programming interface. Additional overvoltage protection is recommended.

DALI luminaires and DALI cables must not be installed or laid in the vicinity of high-voltage equipment. Electrical and magnetic fields can interfere with DALI communication or even destroy DALI components.

If the DALI function is not used but the lines have been laid, they should be short-circuited at a central point to avoid interference (disconnect bus power supply!).

There should be no mixed installations of DALI and DALI-2 peripherals.

Further information is available at: <https://www.dali-alliance.org/>

5.3 DIMC (corridor function with control phase)

The corridor function enables simple power reduction of luminaires to a fixed value by means of an ordinary 230 V control voltage.

In combination with motion sensors or door contacts, high energy savings are possible in rarely used areas.

In the standard setting, the luminaire only provides 100 % luminous flux as long as the control phase is active. After deactivation of the control phase, the luminaire dims down to the background level of 10% within approx. 30 seconds (due to technical limitations, a higher dimming level results for individual versions). The luminaire never switches itself off, but may be switched off by the user at any time.

The graphic shows the luminous flux output of a luminaire with DIMC that is controlled via a motion sensor.

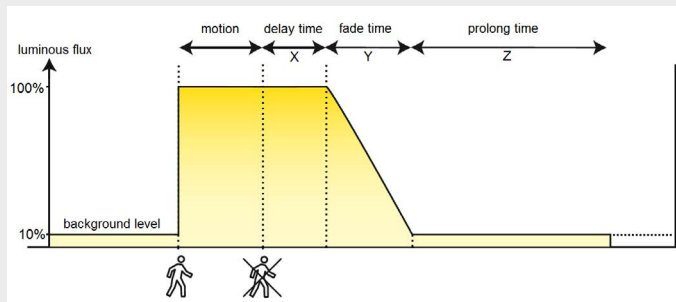

The following default settings are made for luminaires with DIMC. The parameters can be customised on request:

- Delay time: luminaire maintains 100 % luminous flux for time duration X after switching off the control phase (default setting 0 seconds, but customer can set his own „hold time“ by setting the switch-off time delay of the motion sensor).
- Fade time: faster or slower dimming down of the luminaire in time period Y (default setting: approx. 30 seconds)
- Automatic switch-off: Luminaire switches off completely after time period Z without activity. (Standard setting: never switch off; versions Z30: luminaire switches off after 30 minutes)
- Background level: Dimming level when there is no activity. (Standard setting: 10 %; due to technical limitations, a higher dimming level may result for individual versions).

All luminaires with DIMC feature are supplied with a 4-pole terminal.

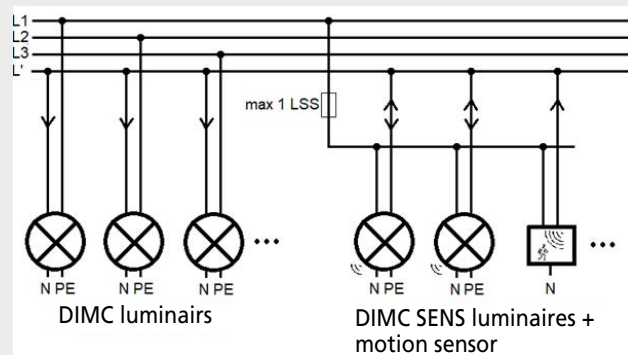

For the different versions, the following instructions must be observed during installation:

- DIMC SENS luminaires have an integrated motion sensor, as well as a connection for the control phase L'. (The connection here is both input and output). For this reason, the supply of all DIMC SENS luminaires, as well as all external motion sensors, must be on the same phase and a common circuit breaker. (-> Note the limited number of luminaires per common circuit breaker).
- DIMC luminaires do not contain an integrated motion sensor. They only have one input for the control phase L' (-> at least one additional external detector or one additional DIMC SENS luminaire is required). The supply of all DIMC luminaires operated on one control phase can be divided among all 3 phases and any number of common circuit breaker. (-> number practically unlimited)

Radar sensors are built into DIMC and SENS luminaires to detect movement.

Objects (e.g. metal partition walls, concrete beams, etc.) that reflect or absorb the radar waves have an influence on the detection range of the sensor. Radar waves can also penetrate lightweight walls, for example, and detect unwanted movements behind these walls. In the vicinity of transmission masts (e.g. on the roofs of parking garages), there may also be functional impairments.

When using external motion sensors/sensors, only units with relay output may be used.

5.4 LR (power reduction with control phase) for outdoor luminaires

In the standard setting, the luminaire delivers 100% luminous flux when the control phase is applied. Without control phase, the luminaire is dimmed to 50 %.

The time until the lower dimming level (usually 50 %) is reached can be up to 180 seconds (comfort function). The 100 % level is reached without any time delay.

Optionally, other dimming levels (10 %-90 %) and an inverse function of the control phase (reduced operation 50 % when control phase is present) are possible.

All luminaires with LR feature have an additional terminal point, labelled LST. The control phase does not have to be in phase with the supply (L).

Chapter 4 describes possible restrictions in the operation of LED outdoor luminaires with power reduction via control phase.

5.5 LA (autonomous power reduction without control phase) for outdoor luminaires

If luminaires with power reduction are to be operated in existing installations where there is no control line, a self-sufficient power reduction can be used.

The time until the dimming level (usually 50 %) is reached can be up to 180 seconds. The same applies to switching back to 100 %. The gradual lowering or raising of the luminous flux of luminaires with power reduction means that switching is not visually perceptible. It thus serves the comfort of the user, as disturbing influences on road users or residents are avoided. Since a visual check of the power reduction is not possible, the change of the luminaire input current or the illuminance should be used for a possibly necessary verification of the proper function.

After the initial start-up, a luminaire needs up to 3 days until the line reduction works reliably.

The luminaire dims completely automatically to different levels (between 10 % and 90 %) at preset times. Several dimming levels per night are possible. Standard: One dimming level, 50% luminous flux from 22:00-04:00 CET and 23:00-05:00 CET.

The luminaire does not use a real-time clock as a timer; instead, the dimming times are recalculated every night from the previous switch-on and switch-off times. This excludes the possibility of deviations in the dimming rate, even after decades of operation.

For this reason, however, it is also not possible to change over to daylight saving time, as the switch-on and switch-off times are determined by twilight. Controlling the luminaires via a timer is not recommended; the dimming times are then dependent on the respective setting.

In Germany, shifts of up to +18 or -18 minutes may occur due to the width of the time zone.

Special programming may be necessary for installation locations outside Germany.

5.6 CL (constant luminous flux function)

Luminaires with feature CL are initially set to approx. 90 % of the output compared to basic types without CL. The luminous flux remains constant throughout the entire service life. The output increases from 90 % to a maximum of 100 % at the end of the service life (100,000 h). After this time, the luminous flux degradation is no longer compensated by an increase in output.

5.7 MA-Z (central monitoring of self-contained luminaires via DALI line)

Up to 64 luminaires with MA-Z version can be centrally monitored via a DALI line. All known restrictions of a DALI system apply (see 5.2).

In addition, a LIMAS Line PRO SCE controller is required (not included in delivery). The emergency luminaires can be switched on and off via a 230 V control phase (L') using a switch.

All control gear is certified according to IEC 62386-202 (DALI-Self-contained emergency control gear).

5.8 DIMD MA-Z (central control and monitoring of self-contained luminaires with DALI-2 ECG)

Up to 32 luminaires with DIMD MA-Z version can be centrally monitored and controlled via a DALI line. All known restrictions of a DALI system apply (see 5.2).

In addition, a LIMAS Line PRO SCE controller is required (not included in delivery).

The emergency luminaires can only be dimmed and switched via DALI-2 compatible control elements/sensors. No 230V control phase may be connected.

All control gear is DALI-2 and certified according to IEC 62386-202 (DALI-Self-contained emergency control gear).

5.9 DI (central monitoring of self-contained Ex luminaires via DALI line)

Up to 64 luminaires with DI version can be centrally monitored via a DALI line. All known restrictions of a DALI system apply (see 5.2).

In addition, a LIMAS Line PRO SCE controller is required (not included in delivery).

The emergency luminaires can be switched on and off via a 230V control phase (L') using a switch.

All control gear is certified according to IEC 62386-202 (DALI-Self-contained emergency control gear).

5.10 DIMDI (central control and monitoring of self-contained Ex luminaires with DALI-2 ECG)

Up to 64 luminaires with DIMDI version can be centrally monitored and controlled via a DALI line. All known restrictions of a DALI system apply (see 5.2). A LIMAS Line PRO SCE controller is required to monitor and control the luminaires (not included in delivery).

The emergency luminaires can only be dimmed and switched via DALI-2 compatible control elements/sensors. No 230 V control phase may be connected.

DIMDI control gear is IEC 62386-202 (DALI-Self-contained emergency control gear) and DALI-2 compatible.

5.11 RFL (luminaire with Zhaga Book 18 socket(s), prepared for light control)

Luminaires with RFL socket (Ready for Lightmanagement System) enable easy retrofitting of light controls and/or sensors. The luminaire does not have to be opened or rewired. All Zhaga Book 18 compatible and D4i certified sensors, IoT nodes etc. are supported. (Due to the variety of systems on the market, we can only provide support for setting up the systems we sell).

Versions:

- RFL0: The luminaire has a socket on the top of the luminaire e.g. for stand-alone photocell or controller with GPS and radio reception.
- RFLU: The luminaire has a socket on the underside, e.g. for stand-alone motion sensors or controller with radio reception.
- RFL0U: The luminaire has 2 interconnected sockets at the top and bottom, e.g. for controller and motion sensor (use only compatible products).
- RFLS: The luminaire has a base without the 24V power supply on pin 1 (only use compatible products).

Due to the design of some luminaires, the socket can only be installed at the top or at the bottom. For Pole-Top luminaires, the socket is located in the luminaire (luminaire must be opened for replacement).

Zhaga and D4i define, among other things, the mechanical and electrical connection of luminaire and Light Management products. The choice of Light Management system can thus be made independently of the luminaire manufacturer. However, different Light Management systems are not compatible with each other!

All luminaires are delivered with sealing caps mounted on the sockets. If no components are installed, the sealing caps must not be removed! Without a cap, the luminaire does not meet the specified IP protection class and warranty claims cannot be made.

When installing the Light Management components, ensure that they engage properly in the socket and that they are firmly seated (bayonet lock).

The connection of non-Zhaga/ D4i compliant adapters, extension cables or devices is not permitted. Electrical and magnetic fields can interfere with radio communication.

In many applications, RFL luminaires are initially operated without Light Management components, but are initially intended to contain special functions that later conflict with the selected Light Management system:

The constant luminous flux function (CL) and the set maximum luminous flux are not affected (for luminaires in VARIO version, the maximum luminous flux can possibly be increased via DIP switch).

All other functions (autonomous dimming LA, control phase LR) are automatically deactivated as soon as the base is used. DIMD (DALI) versions are not possible.

5.12 Important information on the use of RFL luminaires with LIMAS Air CASA

To network RFL luminaires outdoors, each luminaire requires an accessory item called LASC.

For outdoor RFL luminaires, either a USB dongle or at least one RFL LASC DS GPS SIM HUB is required to program RFL LASC DS HUBs. This acts as a gateway and can connect up to 100 RFL LASC DS HUBs in the vicinity to the cloud.

For time-based control, at least one RFL luminaire with an RFL LASC DS GPS SIM must be present. This distributes the system time to all other participants/HUBs within range via a mesh network using its built-in GPS antenna.

Connecting to the cloud incurs ongoing costs. There are no ongoing costs when using the USB dongle.

5.13 Other dimming functions

Other dimming functions are available on request, e.g.:

- amplitude dimming (dimming by varying the mains voltage)
- different dimming levels in emergency lighting mode for luminaires on central battery systems (see also chapter Emergency lighting).

5.14 Limitations when using radar sensors:

Radar sensors work ideally when steady movements in the environment (background noise) are as low as possible.

(background noise) are as low as possible. In heavy fog, rain and branches and leaves moved by wind, the detection of moving objects such as pedestrians, cyclists and cars is made more difficult. Conversely, heavy rain and/or branches and leaves moved by wind, for example, may trigger motion detection. Shrubs and trees in the vicinity of the radar sensor should therefore be continuously cut back. In the vicinity of high-voltage power lines and transmission masts, the function of radar sensors may also be impaired.

5.15 Restrictions on the use of infrared sensors:

IR sensors operate with a pixel-based detection field that detects temperature differences between moving objects (road users) and their surroundings.

The detection range of the sensor depends on the corresponding light spot height and luminaire inclination.

In practical operation, objects cannot be detected under the following conditions:

- Sensor is covered by object (e.g. branch)
- Persons or objects do not have the required size in the detection range of the sensor
- Persons or vehicles are moving at a speed < 1 m/s
- Persons (e.g. with special heat-insulating clothing) or vehicles (e.g. still cold vehicles in winter) do not have a sufficient temperature difference (at least 4 K to the environment).
- People move precisely between the rasterised pixel-based detection points.
- Persons or objects are too far away from the detection range of the sensor.







In addition, there are operating conditions under which the sensor has no function or a malfunction:

- Condensation on the sensor (e.g. in fog) or icing.
- Static charge caused by wind (should, however, be discharged through the earthed luminaire housing).
- Operation outside of the specified operating temperature (see product data sheets)
- Incorrect switching due to air turbulence, e.g. on branches



6. Safety classification for luminaires

The selection of luminaires for certain applications requires the consideration of corresponding protection types and protection classes.

6.1 Ingress Protection Code according to DIN VDE 0711/EN IEC 60598-1

	1 st CHARACTERISTIC NUMERAL	2 nd CHARACTERISTIC NUMERAL	Symbol
RA-TING	SOLID PARTICLE PROTECTION	LIQUID INGRESS PROTECTION	
IP 20	solid objects > 12 mm	non-protected	
IP 23	solid objects > 12 mm	protected against spraying water	
IP 40	solid objects > 1 mm	non-protected	
IP 43	solid objects > 1 mm	protected against spraying water	
IP 44	solid objects > 1 mm	protected against splashing water	
IP 54	dust protected	protected against spraying water	
IP 55	dust protected	protected against water jets	
IP 65	dust tight	protected against water jets	
IP 66	dust tight	protected against heavy seas	
IP 67	dust tight	protected against effects of immersion in water between 15 cm and 1m for 30 minutes	
IP 68	dust tight	protected against effects of immersion in water under pressure for long periods	
IPx9k	dust tight	protected against effects of high pressure water jets	

6.2 Protection classes

	Meaning	Notes
I	 Light fittings with connection point for protective conductor, to which all touchable metal parts must be connected, which can immediately be on mains voltage level in the event of a fault.	Connection to the mains protective conductor is mandatory. The symbol is attached to the connection point.
II	 In the case of such light fittings, no metal parts may be touched that could immediately be on mains voltage level in the event of a fault (protective insulation or double insulation).	The light fitting must not have a protective earth connection and must not be connected to a protective earth conductor (except for functional earth*).
III	 Light fittings for operation with safety extra-low voltage, i.e. with voltages below 42 V, which are generated with a safety transformer according to VDE 0551 or taken from batteries or accumulators.	

* Functional earth: Earthing of a point in a system, which is necessary e.g. to start a lamp or to fulfil EMC requirements.

This is not part of the electrical protection system. Symbol: 

7. Areas of application and properties of SCHUCH luminaires

DIN VDE 0100 must be observed when selecting luminaires. (see section 4).

7.1 Use of moisture-proof luminaires taking into account their degree of protection

Damp-proof luminaires with a high ingress protection (IP 65) are indoor luminaires for ceiling, pendant and trunking mounting (horizontal mounting). If these lumi-



naires are not used as intended, e.g. if they are mounted outdoors, in a different mounting position and/or in extremely high humidity, condensation may occur. In the very dense luminaires, a underpressure is created during the cooling phase after switching off or in the case of strong temperature fluctuations (e.g. mounting in outdoor installations). This can cause moist air to be drawn into the interior of the luminaire and to condense. Water accumulation in a moisture-proof luminaire is thus by no means due to a leaky luminaire, but rather to a luminaire that is too tight. (The tighter the luminaire, the greater the risk of condensation).

For such cases, e.g. for outdoor use, SCHUCH has special luminaires such as the 161/162... AUS series. These luminaires are suitable for unprotected use outdoors. However, it is crucial that the luminaires are switched on regularly for several hours at a time. LUXANO 2 luminaires in HL (high humidity) versions are available for indoor use. These luminaires are equipped with components that are specially protected against moisture. Regular operation is not necessary.



When installing moisture-proof luminaires on cold surfaces, condensation can also occur. In such cases, it is necessary to mount the luminaires at a distance from the mounting surface. Luminaires with protection class IP65 are „jet water protected“. Direct spraying (e.g. during cleaning work) with high-pressure cleaners/steam jets is not permitted. The forces that occur are many times higher than during a water jet test and can lead to water ingress.

7.2 „F“ symbol

Luminaires suitable for mounting on normally flammable surfaces (ignition temperature >200 °C) must be constructed in such a way that in the event of a fault, a maximum of 180°C will occur on the mounting surface.

Such luminaires used to be marked with the -symbol. Luminaires that do not meet the requirements must now be negatively marked with the symbol .

7.3 Luminaires with limited surface temperature „D“ symbol

In areas subject to fire hazards (risk of combustible dust deposits), only luminaires that comply with the requirements of DIN EN 60598-2-24 and bear the  mark may be used. The marking  replaces the -marking previously used in Germany. Examples include lighting installations in paper and wood processing and agricultural premises.

Requirements and information are given in the installation regulations (e.g. VDE 0100 Part 482) and also in the requirements of property insurers (e.g. VDS 2033).

Similar to gases, mists and vapours, all combustible dusts and fluff can also react explosively under certain conditions, i.e. in these cases Ex luminaires must be used.

In case of doubt, consult the supervisory authorities, e.g. the trade inspectorate or the TÜV.

7.4 Frameless glass made of toughened safety glass

Frameless glass must not be damaged by installation or maintenance work, neither on the surface nor in the edge area!

If, for example, a tool hits the edge of the glass and material flakes off, glass breakage cannot be ruled out. Such a breakage can also occur with a considerable time delay after the damage.

7.5 Use of luminaires in animal husbandry

When used in stables, luminaires are particularly exposed to ammonia from animal excrement.

The LED modules mounted in linear luminaires of classic design (e.g. series 161 or 163) and their control gear are damaged by ammonia exposure.

We recommend the use of the Tube light fitting „Primo XR LW“. This luminaire is hermetically sealed to prevent aggressive substances from entering the interior of the luminaire.

The linear luminaire „LUXANO 2 LW“, or other luminaires in the „LW“ or „ER“ versions are also suitable for most agricultural applications. Please consult us.

In poultry farming, the „Primo XR LW DIMD“ luminaire should be used. This meets the special requirements regarding flicker as required by the Federal Ordinance on Livestock Husbandry.

7.6 PC cover glasses

Polycarbonate has the property that it tends to turn yellow under the influence of UV light. PC luminaire cover glasses are exposed to natural UV light when installed outdoors. However, the UV content of the light sources used must also be taken into account.

The polycarbonates we use to manufacture our PC cover glasses are provided with so-called UV additives that improve UV stability.

However, „yellowing“ due to UV radiation cannot be prevented. The additives merely delay this process!

The parameters here are the operating time of the luminaire and the level of UV exposure.

Discolouration of PC glasses does not represent a product defect.

8. Emergency lighting

8.1 Classification and terms

Emergency lighting is divided into safety lighting, spatially limited lighting and replacement lighting, whereby safety lighting is further subdivided in accordance with DIN EN 1838:2025-03 into:

- safety lighting for escape routes
- anti-panic lighting
- safety lighting for workplaces with particular hazards

8.2 Occupational safety

In Germany, occupational safety is divided into two parts. State regulations (e.g. Workplace Ordinance) and the regulations of the German Social Accident Insurance (DGUV) (e.g. DGUV Regulation 3, previously BGV A3) apply.

According to the Workplace Ordinance, which has been in force since August 2004, safety lighting must be provided in workplaces if it is not possible to leave the workplace safely or if there is a risk of accidents in the event of a failure of the general lighting.

The individual regulations are specified in more detail by the „Technical Rules for Workplaces“, which are relevant for safety lighting:

- ASR A1.3 Safety and health protection signage
- ASR A2.3 Escape routes and emergency exits
- ASR A3.4 Lighting and visual

8.3 Electrical engineering requirements

DIN VDE 0108-1, with its comprehensive statements on the design of emergency lighting systems, was withdrawn in March 2007. It was replaced by the European standard DIN EN 50172 (VDE 0108-100), which is now available in its second edition from 2024.

The withdrawal of DIN 0108-1 became necessary because national standards must be withdrawn as soon as a European standard on the same subject is published.

It should be noted that the MVV TB 2023/01 of May 2023, which is binding under building law, refers to an interim status of the revision of DIN EN 50172, which has been published as a pre-standard – DIN VDE V 0108-100-1:2018-12.

8.4 Lighting requirements

The lighting requirements for emergency lighting are regulated in DIN EN1838, although it should be noted that the current edition of this standard from March 2025 is not referenced in the binding Technical Building Regulations (MVV TB 2023/1). The MVV TB still refers to the November 2019 edition of DIN EN 1838.

Emergency lighting

Lighting that comes into effect when the power supply to the general electrical lighting fails.

8.4.1 Safety lighting for escape routes

Definition according to DIN EN 1838: Part of safety lighting that enables users to clearly recognise and safely use the escape route.

The following lighting values must be observed for safety lighting for escape routes:

(Horizontal) **illuminance:** $E_{min} \geq 1$ lx measured on the floor*) of the escape route
 *) According to ASR A2.3, this must be measured as follows: The illuminance must be measured on the centre line of the escape route at a maximum height of 20 cm above the floor or the steps.

Measuring area:

- a) for escape route widths ≤ 2 m, $\frac{1}{4}$ of the width can be disregarded
- b) for escape route widths > 2 m, areas of 0.5 m

at the edges can be disregarded.

Uniformity $U_d = E_{min}/E_{max}$ must not be less than 1:40

Glare limitation:

The (physiological) glare effect of safety luminaires must be limited. This means that, within a specified beam angle of the luminaires, the luminous intensity of the luminaires must not exceed the following values depending on the mounting height:

h = mounting height in metres

I_{max} = maximum permissible luminous intensity in cd at specific exit angles

Colour rendering index: To ensure the visibility of safety colours, the minimum colour rendering index of light sources used in emergency lighting for escape routes must be $R_a > 40$.

8.4.2 Safety lighting for workplaces with particular hazards:

Definition according to DIN EN 1838: Part of the emergency lighting that serves the safety of persons who are in potentially hazardous work processes or situations and enables necessary shutdown measures to be taken for the safety of operating personnel and other building users.

h[m]	< 2,5	2,5 ≤ h < 3	3 ≤ h < 3,5	3,5 ≤ h < 4	4 ≤ h < 4,5	≥ 4,5
I_{max} [cd]	500	900	1.600	2.500	3.500	5.000

The following lighting values must be observed for workplaces with particular hazards:

illuminance: E as close as possible to 10% of the maintenance value of the illuminance of the work area/visual task in question, at least 15 lx

Measurement level: on the work surface

Uniformity $U_d = E_{min}/E_{max}$ must not fall below 1:10

Glare limitation:

h[m]	< 2,5	2,5 ≤ h < 3	3 ≤ h < 3,5	3,5 ≤ h < 4	4 ≤ h < 4,5	≥ 4,5
I_{max} [cd]	500	900	1.600	2.500	3.500	5.000

h = mounting height in metres

I_{max} = maximum permissible luminous intensity in cd at specific exit angles

Colour rendering index: To ensure the visibility of safety colours, the minimum colour rendering index of light sources used in emergency lighting for escape routes must be $R_a > 40$.

8.4.3 Safety signs and markings for escape routes:

A safety sign marking escape routes must be visible from all points along the escape route.

Photometry and colour must comply with ISO 3864, and the symbol used must comply with ISO 7010 – the safety signs to be used in Germany for marking escape routes in workplaces are specified in ASR A1.3.

The luminance of the safety colour green must be at least 2 cd/m² at every point after a power failure.

When connected to the mains, the luminance of the contrasting colour white must be 500 cd/m².

$$\frac{L_{min}}{L_{max}} > 10: 1$$

$$\frac{L_{white}}{L_{green}} = 5: 1 \text{ to } 15: 1$$

The following specification applies to determining the intended recognition distance of a safety sign:

$$l = h \times z$$

where

h = height of the pictogram

z = 100 for illuminated signs

z = 200 for backlit signs

8.5 Use of luminaires in emergency lighting systems with centralised safety power supply systems (ZB)

Many control gear units are labelled as being suitable for 220V DC operation.

This does not mean that they are automatically suitable for centralised emergency power supply systems. These control gear units and the luminaires must meet all the requirements of DIN EN 60598-2-22, which applies to luminaires with a centralised emergency power supply (ZB) and also to self-contained luminaires (EB).

They must meet the requirements of this standard, e.g. section 22.7.3 on protecting the luminaire with, for example, a direct current fuse, or section 22.19 on operation at higher temperatures (70 °C).

8.6 Monitoring LED lights in emergency lighting systems with centralised safety power supply systems

The (common) monitoring modules from INOTEC, CEAG, Ecker/Stahl, etc. for 230 V system voltage monitor the current consumption on the primary side of the control gear and generate an error message if the current falls below a certain value.

LED modules are constructed from series and parallel connections of individual LEDs. Low-resistance failures of individual LEDs in an LED module (on the secondary side of the control gear) do not necessarily lead to a change in current consumption on the primary side that is recognised as an error by monitoring modules!

8.7 Individual monitoring of self-powered LED luminaires

According to DIN EN 50172:2024-10, the status of the power source for safety purposes (ready for operation, fault, power source for safety purposes in operation) must be monitored and displayed at a suitable location. Self-contained emergency luminaires equipped with a display in accordance with EN IEC 60598-2-22 are assumed to meet this requirement if the displayed status is easily recognisable during normal use.

Central monitoring systems and automatic testing systems*) are recommended, especially for installations where the emergency luminaires are difficult to access, e.g. if they are installed at great heights.

*) Automatic testing systems must comply with EN 62034.

SCHUCH supplies luminaires with a DALI interface (see options) for central monitoring.

Additional devices (controller, power supply unit) are required to operate a DALI bus system; these are not included in the scope of delivery of the luminaire.

8.8 Maintenance and testing of emergency lighting systems

Regular maintenance and testing must be carried out to ensure that emergency lighting works when needed.

The test intervals are specified in DIN EN 50172 of 2024-10, Section 7.3 – Initial testing and Section 7.4 – Recurring tests.

8.9 Conversion of general lighting luminaires to emergency luminaires

Converting a general lighting luminaire into an emergency luminaire creates a new product. This new luminaire must comply with all technical regulations and legal requirements applicable to the product, such as RED, LVD, EMC, RoHS, VDE regulations, DIN standards, and a new conformity assessment must be carried out and a new declaration of conformity issued. See 'Information on converting general lighting luminaires to emergency luminaires' (ZVEI 05/2019) for more details.

Literature:

B. Weis, H. Finke: „Not - und Sicherheitsbeleuchtung“, Hüthig & Pflaum-Verlag Fachbuch: ISBN 978-3-8101-0584-4 E-Book/PDF: ISBN 978-3-8101-0585-1

9. Plastics in SCHUCH luminaires

9.1 Chemical resistance

The luminaire housings of many SCHUCH luminaires are made of **glass-fibre reinforced polyester**. This material is heat-resistant, mechanically stable, electrically insulating, weatherproof and chemically resistant.

The luminaire covers are usually made of silicate glass, polycarbonate (PC) or polymethyl methacrylate (PMMA).

For polycarbonate (PC) and polymethyl methacrylate (PMMA), their resistance to various chemical substances - according to the current knowledge of the relevant material manufacturers - is given below. Experience shows that the temperature of chemical (aggressive) substances often plays a significant role.

Parts made of polycarbonate (trade name Makrolon, Lexan etc.) are more impact resistant and heat resistant than parts made of PMMA (trade name Diakon, Plexiglas etc.). Polycarbonate is not resistant to all agents. For cleaning, we recommend warm water with a weakly alkaline detergent, e.g. REI and PRIL. Afterwards, rinse well with clear water. After rinsing, there must be no residual cleaner on the treated luminaire. The pH value of the cleaner must be less than 7.5. For this reason, no soap or similar should be used. In particular, we would like to point out that PC is not resistant to oils and greases! For moisture-proof diffuser luminaires with plastic caps, their chemical resistance must also be taken into account (please consult us). In many cases, KE fasteners (made of stainless steel) are an alternative.

Material	Poly-methylacrylat (PMMA)	Polycarbonat (PC)	Thermoplastic polyester (PBT)
Acetone	–	–	–
Ethylalcohol (to 30 %)	o	o 96 % ¹⁾	+
Battery acid	+	+	n/a
Ammonia	+	–	+ up to 10 % ¹⁾
Boric acid 3 %	+	+	n/a
Sodium Hypochlorite	+	–	n/a
Chlorine (moist)	–	–	n/a
Chromium acid 10 %	o	+	n/a
Acetic acid concentrated	–	–	–
Acetic acid (up to 10%)	+	+ < 10 % ¹⁾	+
Formaldehyde (up to 10%)	o	+	n/a
Glycerin	+	o	+
Uric acid (up to 20 %)	+	n/a	n/a
Potassium (20-25 °C)	+	–	–
Kerosene (aviation gasoline)	o/–	–	+
Sea water	+	+	+
Methyl alcohol (up to 23 °C)	o/–	–	+
Lactic acid < 4 %	+	+	n/a
Sodium chloride	+	+	+ up to 10 % ¹⁾
Sodium hydroxide Solution 20-25 °C	+	–	+
Petroleum	o	o	+
Phosphoric acid Concentrated	–	+ 10 up to 30 % ¹⁾	+ 25 % ¹⁾
Soap liquor (at 23 °c)	+	o	up to 10 % OK
Sulfuric acid H2SO4	–	–	–
Sulfuric acid up to 30 %	+	+	+ bis 10 % ¹⁾
Sulphur dioxide dry (at 23 °C)	–	o	n/a
Turpentine (at 23 °C)	+/o	–	+
Toluene	–	–	–
Acidity of wine	+ up to 50 % ¹⁾	+ up to 10 % ¹⁾	n/a
Citric acid up to 20 %	+	+	+ up to 10 % ¹⁾

Legend: + = resistant, O = limited resistant – = volatile (unstable) ¹⁾ = concentration

10. Corrosion resistance of sheet steel luminaires

Our sheet steel luminaires are powder-coated with a high-quality polyester lacquer.

In addition to corrosion protection, the coating offers very good scratch resistance.

Depending on the conditions of use at the installation site, however, corrosion on the housings cannot be completely ruled out.

Examples of this are applications with permanent humidity, mounting locations near lakes under canopies or areas with aggressive media/chemicals.

For such conditions, depending on the requirements, we offer modified versions with KTL coating, aluminium or VA enclosures.

11. Glare evaluation in industrial lighting

A distinction is made between 2 types of glare:

1. Discomfort glare

This causes an unpleasant sensation without necessarily involving a noticeable reduction in visual acuity.

2. Disability glare

This results in a reduction in visual function.

The United Glare Rating (UGR) method was developed to standardise the assessment of discomfort glare caused by indoor/office lighting worldwide.

In industrial lighting, however, it is usually a question of visual performance and thus of disability glare, which is essential for occupational safety and accident prevention.

The UGR method cannot assess disability glare. Accordingly, it is not taken into account in lighting design in industrial plants. The UGR method is therefore not suitable for assessing the glare of lighting installations in industrial applications, especially for hall lighting.

A suitable procedure must be developed for these applications in the future. The relevant expert committees in the ZVEI have already taken up this task.

Detailed information:

- ZVEI position paper „UGR method - application and limits“.
www.schuch.de/de/Positionspapier-UGR_ZVEI
- Statement „Glare assessment in industrial lighting“ by Prof. Dr. Bruno Weis, Technical Manager Adolf Schuch GmbH
www.schuch.de/de/Blendungsbewertung-Industriebeleuchtung_Weis

12. Adaptive lighting

Adaptive lighting refers to intelligently controlled lighting systems that dynamically adapt their characteristics to the environment and the needs of users. This includes:

- Motion- and presence-controlled luminaires
- Daylight-controlled luminaires
- Time-controlled luminaires (LA and LR versions)
- Networked outdoor luminaires and advance lighting (LIMAS Air SYNC)
- Weather-controlled luminaires

Adaptive lighting enables, for example, the variation of light colour in outdoor areas: high-contrast neutral white light for better recognition of objects and hazards during periods of high traffic density. And during the night, warm white light, which has a positive effect on the circadian rhythm and well-being (EcoTune). The light distribution can also be adjusted. For example, façade lighting can be reduced during late night or glare from wet roads can be significantly reduced. Daylight- and presence-dependent control (LIMAS Air CASA and LIMAS Line BASIC + PRO) ensures optimal lighting in the workplace while reducing energy consumption.

Literature:

B. Weis, G. Finke: Emergency and safety lighting, Hüthig & Pflaum-Verlag. ISBN 978-3-8101-0584-4

B. Weis, J-G. Kaiser, N. Wittig: Industrial lighting, Hüthig & Pflaum-Verlag
Volume 1: Fundamentals - Standards - Regulations ISBN 978-3-8101-0370-3
Volume 2: Installation regulations - Applications ISBN 978-3-8101-0391-8

Summery of the products

Series	Page	Series	Page	Series	Page	Series	Page
107... LW (dust-/waterproof)	120	167... G2 LW (dust-/waterproof)	113	7800... SSK (high bay)	159-160	LUXANO 2 (dust-/waterproof)	107-114
107... (dust-/waterproof)	119-120	167... G2 MA (emergency)	241	7950... (outdoor)	219-223	LUXANO 2 (emergency)	240-241
110... H50 (dust-/waterproof)	122	167... G2 T40/H50 (dust-/waterproof)	112	7955... RFL... (high bay)	155	nd822... DIMD (explosion)	59
110... (dust-/waterproof)	121-122	167... G2 VARIO FC (dust-/waterproof)	109	7955... SBL (high bay)	155	nd822... (explosion)	58-60
130/131... G2 (dust-/waterproof)	118	167... VARIO ZB (emergency)	241	7955... V (high bay)	156	nd8301/02... (explosion)	61-62
131 nGgB DB (outdoor)	179	185... (dust-/waterproof)	124-126	7955... (high bay)	153-156	nd8611... (explosion)	56-57
131... (emergency)	244-245	190... (dust-/waterproof)	123	8040 (explosion)	74	nd866... DIMD (explosion)	51
131... W MA (emergency)	245	3301 ... ER (high bay)	150	8118 (explosion)	74	nd866... H.. (explosion)	51
131... ZB (emergency)	245	3301... LW (high bay)	150	AREALO 2 (outdoor) (7950...)	219-223	nd866... (explosion)	50-52
142... (dust-/waterproof)	127-128	3301... SBL (high bay)	150	AREALO 2 (high bay) (7955...)	153-156	nd867... (explosion)	53-55
144... AUS (dust-/waterproof)	100	3301/02... IFS (high bay)	149	BELLA - VARIO (564/565 G2)	208-210	nd8700... A (explosion)	66
144... (dust-/waterproof)	99-100	3301/02... VARIO (high bay)	149	CAMINO - RFL (48/47...)	173	nd8700... (explosion)	65-66
161... (emergency)	236-237	3301/3302... (high bay)	147-150	CAMINO - VARIO (48/47...)	172	nd8800... A (explosion)	68
161... ER / HR (dust-/waterproof)	97	3305... IFS (high bay)	152	CAMINO (48/47...) (outdoor)	170-174	nd8800... (explosion)	67-68
161... FF / FC (dust-/waterproof)	98	3305... (high bay)	151-152	CAPA - VARIO (541... G2)	199-201	nd8950... (explosion)	69-70
161... H50 (dust-/waterproof)	94	3401/3402... G3 (high bay)	136-140	CILA - VARIO (558... G2)	196-198	nd8955... (explosion)	63-64
161... MA (emergency)	237	3403... G3 (high bay)	141-142	Connection cable (outdoor)	227	PENDO - (explosion)	180-182
161... SENS (dust-/waterproof)	92-93	3405... G3 (high bay)	143-144	Crossbars (outdoor)	226	PENDO - RFL (59/49...)	182
161... VARIO (dust-/waterproof)	91/95/96	3410/3420/3430... (high bay)	145-146	CUPINA - VARIO (556... G2)	190-192	PENDO - VARIO (59/49...)	181
161... ZB (emergency)	237	3610... (dust-/waterproof)	115	DUEVO (3301/3302)	147-150	PLANEO - VARIO (557... G2)	183-195
161/162... AUS (dust-/waterproof)	95	3611... (emergency)	246-247	DUEVO XL (3305)	151-152	Pole arm carriers (outdoor)	224
161/162... IFS / LM (dust-/waterproof)	95-96	3611... MA (emergency)	246	DV (explosion)	72	Pole-top brackets (outdoor)	225-226
161/162... T40 / H.. (dust-/waterproof)	94	3611... ZB (emergency)	247	DV (dust-/waterproof)	131	PRIMO XR (107...)	119-120
161/162... RLED OV (dust-/waterproof)	106	3611... (dust-/waterproof)	116	e821 ... DIMD (explosion)	43	PROXIMA (dust-/waterproof) (161PX...)	80-89
161/VARIO/162 (dust-/waterproof)	90-98	42/42 ... AL VARIO (outdoor)	175-176	e821... (explosion)	42-43	PROXIMA (emergency) (161PX...)	232-233
161... VARIO (dust-/waterproof)	91	4210 (explosion)	73	e840... PM (explosion)	36	REDONDO - RFL (55...)	185
161... VARIO AUS (dust-/waterproof)	95	4216 (explosion)	73	e840... (explosion)	35-36	REDONDO - VARIO (55...)	184
161PX... AUS (dust-/waterproof)	85	46... G2 VARIO (outdoor)	177-178	e855... (explosion)	37-38	REDONDO (55...)	183-185
161PX... CS (dust-/waterproof)	84	47... DB (outdoor)	174	e856... (explosion)	39-41	RETRO - VARIO (543... G2)	202-204
161PX... ER / HR (dust-/waterproof)	88	47... FUE (outdoor)	171	e864... (explosion)	32-34	RETRO Z - VARIO (553... G2)	205-207
161PX... FC (dust-/waterproof)	89	48/47... (outdoor)	170-174	e865... (explosion)	29-31	RFL	22-24
161PX... H50 (dust-/waterproof)	84	48/47... RFL (outdoor)	173	e865... DIMD (explosion)	30	SEGURO (142...)	127-128
161PX... H50 MA (emergency)	234-235	48/47... VARIO (outdoor)	172	e865... H.. (explosion)	30	TRIANO disc (3410/20/30...)	145-146
161PX... HE (dust-/waterproof)	88	51/52 ... RFL (outdoor)	169	e865... T40 (explosion)	30	TRIANO G3 (3401/3402... G3)	136-140
161PX... IFS / LM (dust-/waterproof)	86-87	51/52 ... VARIO (outdoor)	168	e8820... DIMD (explosion)	47	TRIANO L G3 (3403... G3)	141-142
161PX... MA (emergency)	233	51/52 ... (outdoor)	166-169	e8820... (explosion)	46-47	TRIANO XL G3 (3405... G3)	143-144
161PX... SENS (dust-/waterproof)	82-84	541... G2 (outdoor)	199-201	e8825... DIMD (explosion)	45	TRS 2000/AL (dust-/waterproof)	129
161PX... T40 (dust-/waterproof)	85	541... G2 VARIO (outdoor)	201	e8825... (explosion)	44-45	TRS 1000	130
161PX... T40 / H.. (dust-/waterproof)	85	543... G2 (outdoor)	202-204	e9310... (explosion)	49	TRS 2000/AL (explosion)	71
161PX... TB / T (dust-/waterproof)	86	543... G2 VARIO (outdoor)	204	e9312... (explosion)	48	TUBE0 (110...)	121-122
161PX... VARIO (dust-/waterproof)	81/85/87	544... G2 (outdoor)	186-189	EcoTune	25	VIA - RFL (51/52...)	169
161PX... ZB (emergency)	233	544... G2 RFL (outdoor)	189	ExAREALO 2 (nd8950)	69-70	VIA - VARIO	168
161PX... (emergency)	232-233	544... G2 VARIO (outdoor)	188	ExAREALO 2 (nd8955)	63-64	VIA (51/52...)	166-169
161PX.../VARIO (dust-/waterproof)	80-89	55... RFL (outdoor)	185	ExDUEVO (nd8301/02...)	61-62		
162... DB (dust-/waterproof)	97	55... VARIO (outdoor)	184	ExeLED 1 (e865...)	29-31		
162... TB (dust-/waterproof)	94	55... (outdoor)	183-185	ExeLED 1 N (e864...)	32-34		
163 G2 VARIO/164... G2 (dust-/waterproof)	101-105	553... G2 (outdoor)	205-207	ExeLED 2 (nd866...)	50-52		
163... G2 (emergency)	238-239	553... G2 VARIO (outdoor)	207	ExeLED 2 N (nd867...)	53-55		
163... G2 SENS (dust-/waterproof)	103-104	556... G2 (outdoor)	190-192	ExFOCO L (nd8700...)	65-66		
163... G2 VARIO (dust-/waterproof)	102/105	556... G2 VARIO (outdoor)	192	ExFOCO XL (nd8800...)	67-68		
163... G2 VARIO SBL (dust-/waterproof)	105	557... G2 (outdoor)	193-195	ExGLOBE (e9312...)	48		
163... MA (emergency)	239	557... G2 VARIO (outdoor)	195	EX-Installation materials	71-74		
163/164... IFS (dust-/waterproof)	102	558... G2 (outdoor)	196-198	EXSPECT (e9310...)	49		
163/164... RLED (OV) (dust-/waterproof)	106	558... G2 VARIO (outdoor)	198	ExSTREAM (e8820...)	46-47		
163... G2 T40/H50 (dust-/waterproof)	105	564/565... G2 (outdoor)	208-210	ExSTREAM (e8825...)	44-45		
163... VARIO ZB (emergency)	239	564/565... G2 VARIO (outdoor)	210	FILOS (42 VARIO/42 AL VARIO)	175-176		
164 KL... (emergency)	242-243	59/49... RFL (outdoor)	182	FOCO (high bay) (7600... SBL)	157-158		
164 KL... MA (emergency)	242	59/49... VARIO (outdoor)	181	FOCO L (high bay) (7700... SBL)	157-158		
164 KL... ZB (emergency)	243	59/49... (outdoor)	180-182	FOCO L (high bay) (7700... SSK)	159-160		
164KL... G2 (dust-/waterproof)	117	7600 ... SBL (HAL)	157-158	FOCO L VARIO/RFL (outdoor) (7700...)	214-218		
167... G2 (dust-/waterproof)	107-114	7600 ... VARIO (outdoor)	211-213	FOCO VARIO/RFL (outdoor) (7600...)	211-213		
167... G2 (emergency)	240-241	7600 ... VARIO RFL (outdoor)	213	FOCO XL (high bay) (7800... SSK)	159-160		
167... G2 AUS/VARIO (dust-/waterproof)	108	7700 ... SBL (high bay)	157-158	FOCO XL (high bay) (7800... SBL)	157-158		
167... G2 ER DIMD (dust-/waterproof)	113	7700 ... SSK (high bay)	159-160	FOCO XL VARIO/RFL (outdoor) (7800...)	214-218		
167... G2 HE CS (dust-/waterproof)	112	7700/7800 ... RFL (outdoor)	217	KONIC - VARIO / RFL (544... G2)	186-189		
167... G2 HE VARIO (dust-/waterproof)	108	7700/7800 ... VARIO (outdoor)	216	LIMAS Air (SYNC/CASA/GUARD)	15-17		
167... G2 HL (dust-/waterproof)	112	7700/7800 ... (outdoor)	214-218	LIMAS Line (BACIC / PRO / ESC)	18-20		
167... G2 IFS/VARIO (dust-/waterproof)	109	7800 ... SBL (high bay)	157-158	LUCA (46... G2 VARIO)	177-178		

**With passion for
excellent lighting – since 1895!**



Adolf Schuch GmbH
Lichttechnische Spezialfabrik
Mainzer Straße 172 • 67547 Worms
PO Box 21 45 • 67511 Worms
Telephone: +49 6241 4091-0
info@schuch.de • www.schuch.de

